



OPERATING MANUAL
XL2-TA HANDHELD AUDIO AND
ACOUSTIC ANALYZER

Contact NTi Audio at

Headquarter	 +423 239 6060	 info@nti-audio.com
Americas	+1 503 684 7050	americas@nti-audio.com
China	+86 512 6802 0075	china@nti-audio.com
Czech	+420 2209 99992	czech@nti-audio.com
France	+33 4 78 64 15 68	france@nti-audio.com
Germany	+49 201 6470 1900	de@nti-audio.com
Japan	+81 3 3634 6110	japan@nti-audio.com
South Korea	+82 2 6404 4978	korea@nti-audio.com
United Kingdom	+44 1438 870632	uk@nti-audio.com

www.nti-audio.com

Firmware V4.82

Version 4.71.00 / 11. August 2022

All information subject to change without notice.

© All rights reserved.

® Minirator is a registered trademark of NTi Audio.

™ XL2-TA, EXEL, M2230, M2211, M2215, M4260 and MA220
are trademarks of NTi Audio.

Made in
Switzerland



Table of Contents

1. Introduction	5	5. Acoustic Analyzer	64
2. Overview	7	FFT Analysis + Tolerance.....	64
Operation	9	Reverberation Time	74
The Screen Display	11	Polarity	86
3. Getting Started	14	Delay Time	90
Power Supply	14	1/12 Octave + Tolerance (optional)	96
Attaching the Hand Strap	17	Noise Curves (optional).....	108
Unfolding the Stand	18	Speech Intelligibility STIPA (optional)	118
Connecting the XL2-TA	18	6. Audio Analyzer	135
Switching the XL2-TA On and Off	20	RMS / THD+N	135
Select Measurement Function.....	20	Oscilloscope	138
Calibration prior Measurement	21	7. Vibration Meter	139
4. Sound Level Meter	22	VibMeter / Spectrum	139
Overview	26	FFT Analysis + Tolerance.....	146
Sound Level Meter - Getting Started	34	Oscilloscope	150
RTA Measurement - Getting Started	39	1/12 Octave + Tolerance (optional)	151
Reporting	43	8. Calibration	156
Wav-File Recording	46	9. Profiles	163
Events (optional)	49	10. Spectral Limits Option (Capture + Tolerances)	170
Limits	56	11. System Settings	183
Correction Value KSET	58	Settings.....	183
Locked Run Mode.....	62		









Vibration.....	186	Warranty Conditions	271
Scheduler	187	Service and Repairs	272
Options	189	Calibration Certificate.....	272
Information	190	Declaration of Conformity.....	274
12. Data Management	191	23. Technical Data XL2-TA	276
Record Voice Notes.....	197	24. Technical Data Microphones	288
Recall Measurements.....	203	25. Technical Data PreAmplifier.....	298
Append Measurements	205	Appendix	299
13. XL2 Projector PRO Software.....	210	Appendix 1: Standard - Optional Features	299
14. Data Explorer (optional).....	212	Appendix 2: Factory Default Profiles	303
15. Building Acoustics (optional).....	214	Appendix 3: Description Sound Levels	308
16. Room Acoustics (optional).....	216	Appendix 4: Common Sound Levels.....	313
17. Sound Power (optional).....	218	Appendix 5: Vibration Meter Functions.....	319
18. Unattended Noise Monitoring	220	Details IEC 61672 & IEC 61260.....	322
19. Time Synchronization.....	226	General Information	324
20. Remote Measurement.....	230	Class 1 Sound Calibrator.....	327
21. Microphones	232	Accessory	327
22. Further Information	246	Level Linearity.....	328
My NTi Audio	246	Level Linearity of Octaveband-Spectrum	330
Firmware Update	249	Level Linearity of Third-Octaveband-Spectrum	331
Options	250	Self-generated Noise with Microphone	332
Accessories	260	Frequency Response Corrections	334
		Frequency Weighting	338
		Directional Response (dB)	339
		Information for Calibration	344

1. Introduction

Thank you for purchasing the XL2-TA Audio and Acoustic Analyzer. The XL2-TA Analyzer forms the unique combination of a state-of-the-art Sound Level Meter, a comprehensive Acoustic Analyzer as well as a powerful Audio Analyzer. The wide range of functionalities is tailored for:

- Evacuation Systems
 - Speech Intelligibility
- Electroacoustic Installations
 - Installed Sound
 - AV Installations
 - Cinemas
- Noise Measurement
 - Unattended Noise Monitoring
 - Environmental Noise
 - Occupational Health
 - Vehicle Noise
 - Sound Power
- Live Sound
 - Sound Level Monitoring
 - Front of House
 - PA Rental
- Broadcast
 - Room & Building Acoustics
 - Room Acoustics
 - Building Acoustics
 - Reverberation Time
 - Noise Curves
 - Industrial Quality Control
 - Condition Monitoring

How to Read this Manual

The XL2-TA push buttons are displayed as icons    , , , , . A detailed description of the push buttons is listed in the chapter Overview - Operation.

Menu items displayed on the XL2-TA page screens are shown in this user manual by a bold font, e.g., **SLMeter**, **Parameter**, ...

Product Configurations

The following items are included with the respective model:

XL2-TA +
M2230:

- XL2-TA Analyzer
- M2230 Measurement Microphone consisting of
 - Microphone PreAmplifier MA220
 - Microphone Capsule MC230 or MC230A
- 50 mm Windscreen
- Microphone-holder MH01 with Adapter 5/8" - 3/8"
- Individual Frequency Response Chart
- USB Flash Drive
- Li-Po battery
- USB cable
- Hand strap
- Operating manual

XL2-TA +
M2340:

- XL2-TA Analyzer
- M2340 Measurement Microphone consisting of
 - Microphone PreAmplifier MA230
 - Microphone Capsule MC230A
- 50 mm Windscreen
- Microphone-holder MH01 with Adapter 5/8" - 3/8"
- Individual Frequency Response Chart
- USB Flash Drive
- Li-Po battery
- USB cable
- Hand strap
- Operating manual

2. Overview

XL2-TA interfaces:

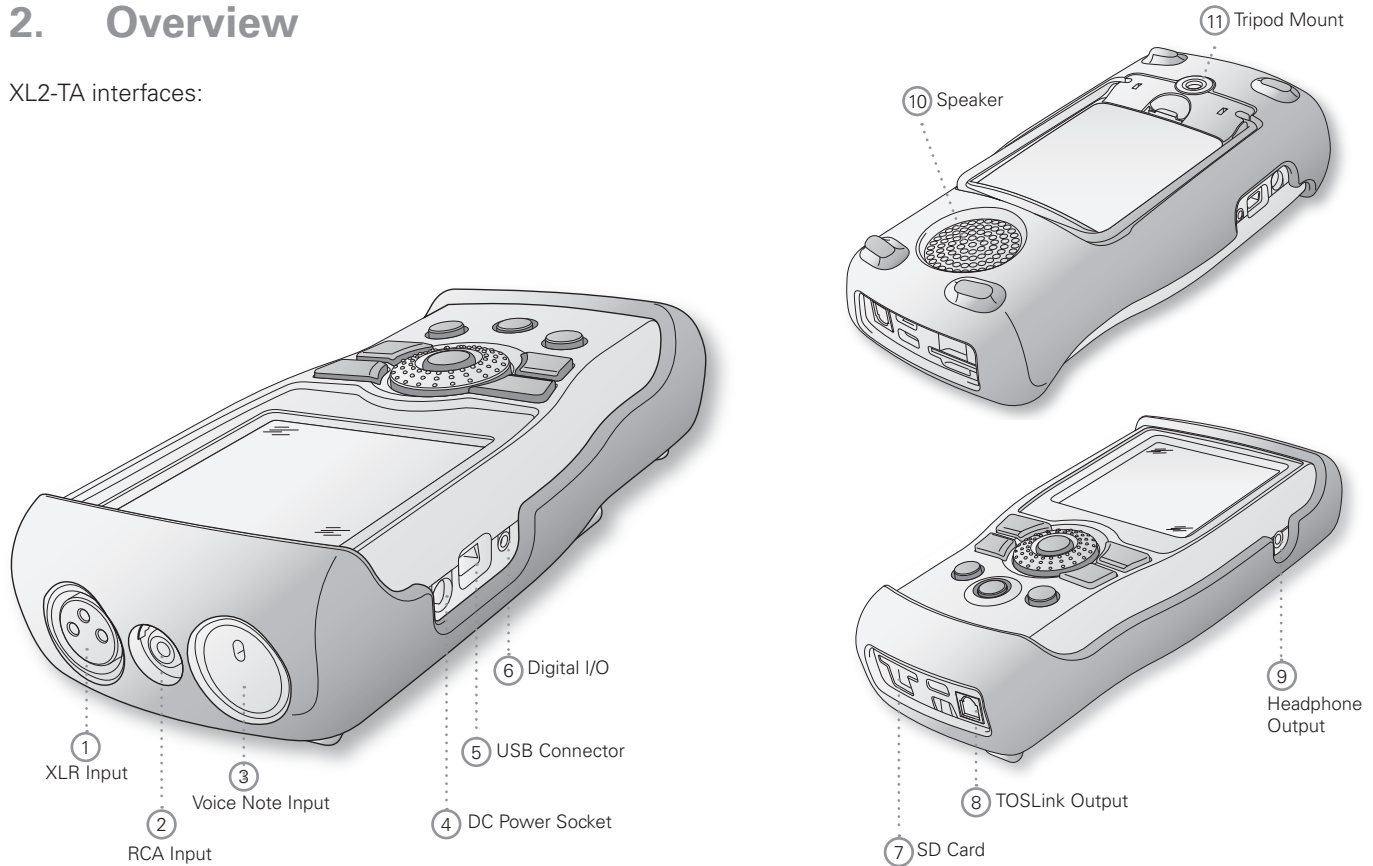

① XLR Signal Input

Either a balanced audio signal, an NTi Audio measurement microphone or the microphone pre-amplifier MA220 plug directly into the XLR input. The Automated Sensor Detection (ASD) technology reads the electronic data sheet of any connected NTi Audio device after the 48 V microphone phantom power is activated.

② RCA Input

Unbalanced audio signal input.

③ Voice Note Input

Internal microphone for recording voice notes and measuring polarity and delay time. For polarity measurements, an external microphone may also be used.

④ DC Power Socket

Socket for mains power adapter. Further details in the chapter Power Supply in this manual.

⑤ USB Connector

Mini-B USB connection, for accessing the SD Card.

⑥ Digital I/O

Programmable digital inputs/outputs.

⑦ SD Card

For storing data, screenshots, voice notes, wav-files - required to power on and run the instrument.



⑧ TOSLink Output

24 bit linear PCM audio signal output. For future use; not active at this time.

⑨ Headphone Output

The XLR/RCA input signals are routed to the headphone connector (3.5 mm Minijack; mono monitor wired to both channels of stereo jack). Connecting headphones mutes the internal speaker. To connect the headphone output directly to a line input, a load impedance $< 8 \text{ k}\Omega$ is required for proper operation. This can be achieved by inserting a $1 \text{ k}\Omega$ resistance between tip and ground of the output jack.

⑩ Speaker

The XLR/RCA input signals are routed to the speaker. Press the speaker button  to toggle the speaker on/off. Press and hold the speaker button to access the volume control. Set the speaker level with the rotary wheel .

⑪ Tripod Mount

Mechanical mount for attaching the XL2-TA to a tripod or microphone stand.

Operation

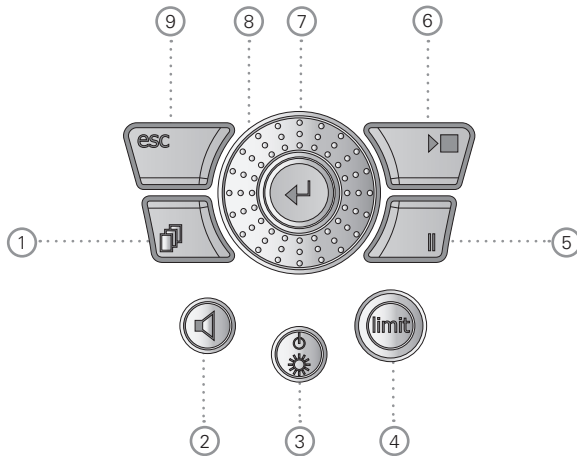

① Page Control

Switches among various screens depending on the menu function selected.

② Volume of Speaker and Headphone Output



- Press the button briefly to enable or disable the speaker.

The speaker is activated and the speaker or headphone icon appears in the upper menu bar.

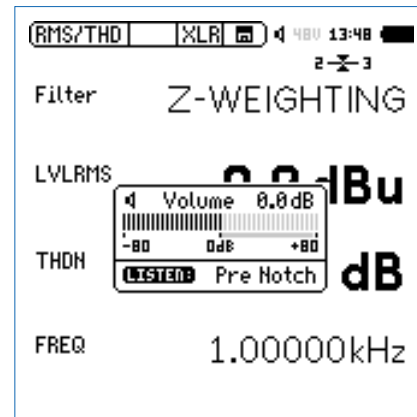

- Press and hold the speaker button .

A pop-up window for volume is displayed.



- Hold the speaker button  down and adjust the level of the speaker and headphone outputs with the rotary wheel . Digital gain control prevents gain increases beyond a level that will cause signal clipping. The maximum gain setting depends on the connected input signal.
- The headphone output provides a linear output signal using the **SLMeter** function over a measurement range of 57 dB. The minimum Z-weighted sound pressure level at reference sensitivity is:
 - M2230, M2340: 58 dB
 - M2211: 64 dB
 - M4261: 66 dB

3 Power & Backlight



The power button  switches the instrument on. The XL2-TA is immediately ready for operation. Holding down the power button  for one second switches the XL2-TA off. Additionally, a brief press of the power button  toggles the backlight during operation.

4 Limit

- **SLMeter**: The limit button lights up green, yellow or red according to the settings in the **Limit** page. Press the limit button  to access the **Limit** page. For more details visit the chapter Sound Level Meter: Limits.

- **FFT + Tol**: The limit button lights up green for results within tolerance and red for out-of-tolerance results.
- **Polarity**: The limit button lights up green at positive polarity and red at negative polarity.
- **1/12 Oct + Tol**: The limit button lights up green for results within tolerance and red for out of tolerance results.

5 Pause

Pauses the current measurement. Press the pause button  or the start/stop button  to continue the measurement. The data logging is continued in the function **SLMeter/RTA** during the pause period and listed in the log file.

6 Start/Stop

Starts and stops a measurement.

7 Enter

Confirms a selection.

8 Rotary Wheel

Selects the required measurement function or the individual measurement parameter.



9 ESC

Terminates an entry, returns to the top menu level or closes an open window.

The Screen Display

The XL2-TA displays the actual sound levels also in case of no measurement has been started. Any displayed averaged level refers to the previous measurement period. The XL2-TA shows four lines in case of no previous measurement period is applicable.

Display Contrast Setting

- Hold down escape  and turn the rotary wheel  until the desired contrast is reached.

Updating of display

- Numeric values
Updated every 500ms independent of the measurement function. The maximum time span between the end of the measurement period and the first test result display is 500ms.
- Graphs and spectra
Updated every 50ms

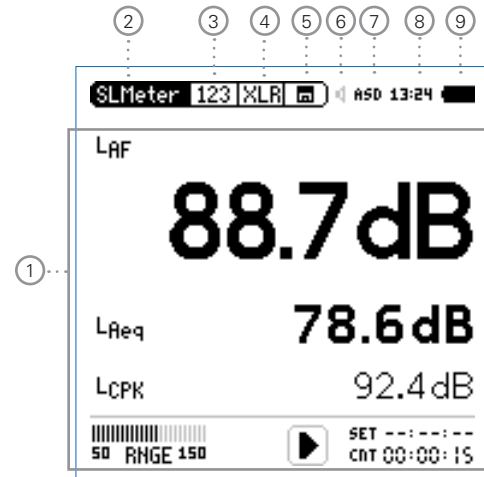

The display is updated continuously during measurement.

① Measurement Results

Individual level measurement results.

② Main Menu

SLMeter/RTA	SPL & RTA Measurement
FFT + Tol	FFT Analysis with optional Tolerance Management
RT60	Reverberation Time
Polarity	Polarity
Delay Time	Delay Time
RMS/THD+N	RMS Level and Distortion
Oscilloscope	Scope
1/12 Oct + Tol	Spectral Analysis with Tolerance Management (optional)
Noise Curves	Noise Curves
STIPA	Speech Intelligibility (optional)
Cinema Meter	Calibration and verification of cinema loudspeaker systems (optional)
Calibrate	Calibration Menu for microphone
Profile ...	Store and load measurement profiles
System	System Settings

③ Page Selector

Toggles between available measurement and result pages within the same function menu. Alternatively use the page button .

④ Input Selector

Select XLR or RCA input connectors as the source.

⑤ Memory Menu

The memory menu is used for data storage management. One of the following symbols flashes before or after starting the measurement:

9-8-7 Time in seconds until instrument is settled and measurement will start.

RUN Indicates the ongoing measurement.

LOG Indicates the ongoing measurement with data logging.

AUD Indicates the ongoing measurement with data logging and audio recording.

Evt Indicates an ongoing triggered-event recording.

After a completed measurement, the memory symbol  indicates a non-saved measurement report. Your measurement needs to be stored manually. For more details visit the chapter Data Management.

⑥ Speaker/Headphone

Indication of enabled rear speaker or headphone output.

⑦ Phantom Power Supply

48V The XL2-TA provides 48 V phantom power supply to the connection microphone or sensor.

ASD An NTi Audio measurement microphone with automated sensor detection ASD is connected. The XL2-TA reads the electronic data sheet of the microphone and switches the 48V phantom power automatically on

48V Phantom power is switched off.

⑧ Real-Time Clock

The real-time clock is set in the **System** menu.

⑨ Battery Symbol

The battery symbol indicates the battery status as follows:

Using rechargeable Li-Po battery:

 Level indication 100% ($U > 4.0$ Volt).
(Battery charges when mains adaptor connected)

 Level indication:
75%: $U = 3.9 - 4.0$ Volt
50%: $U = 3.8 - 3.9$ Volt
25%: $U = 3.7 - 3.8$ Volt

 Level indication 0% ($U < 3.7$ Volt). The battery is almost empty and must be recharged.

 The battery is being recharged by the mains power adapter.

 The XL2-TA is connected via USB to a computer. The battery charge level decreases slowly during XL2-TA usage.

Using standard AA batteries:

No level indication as long as $U > 4.5$ Volt.

 Level indication 0% ($U < 4.5$ Volt). The batteries are almost empty and should be replaced.

Using mains or supply:

No indication of battery status.

3. Getting Started

Power Supply

The XL2-TA offers flexible power management options and can be operated either by

- Replaceable, rechargeable lithium-polymer (Li-Po) battery (included with the XL2-TA Analyzer)
- 4x AA-batteries
- Mains Power Adapter

The new battery is charged to approximately 50% and should be fully charged before use with:

Battery Charger (optional) Charging Time: approx. 3 hours
NTi Audio #: 600 000 332

Mains Power Adapter (optional) Charging Time: approx. 6 hours
Leave the battery inside and switch off the XL2-TA . Running the XL2-TA during charging prolongs the charging time.
NTi Audio #: 600 000 333

USB Power from PC Charging Time: approx. 6 hours
Switch off the XL2-TA  for charging. The charging power is equal or less than the power consumption.

Operation using Mains Power Supply

You can also operate the XL2-TA with the optional NTi Audio Mains Power Adapter. During such operation it is recommended to leave the batteries inside the instrument.



Mains Power Adapter

- Electrically-isolated, linear DC power supply
- A decreased THD+N performance will occur with unbalanced input signals when using switching-type power supplies (approx. 3 dB).
- Non-NTi Audio power supplies may have further negative effects on measurements.
- Damage caused by using an inappropriate external DC supply is not covered by warranty.



DC Power supply specifications

- Voltage: 7.5 - 20.0 Volt
- Power: minimum 6 Watt
- Connector type: 2.1 x 5.5 x 9.5 mm
- Polarity: +  -.

Rechargeable Li-Po Battery

- Open the battery cover at the rear of the instrument.
- Insert the rechargeable battery with the contacts edge first.
- Close the battery cover.



Switch off the XL2-TA  for faster recharging by mains power adapter or USB connection.



Caution

- Switch the XL2-TA off prior opening the battery cover in order to prevent any electronic discharges.
- Avoid short-circuits.
- Operate and charge the battery between 0°C and 45°C (32°F - 113°F).
- Do not heat the battery above 60°C.
- Do not place the battery in or near fire.
- Do not solder directly on to the battery.
- Do not disassemble the battery.
- Do not insert the battery in reverse polarity.
- Remove the battery for applications with a connected mains power adapter over multiple weeks.

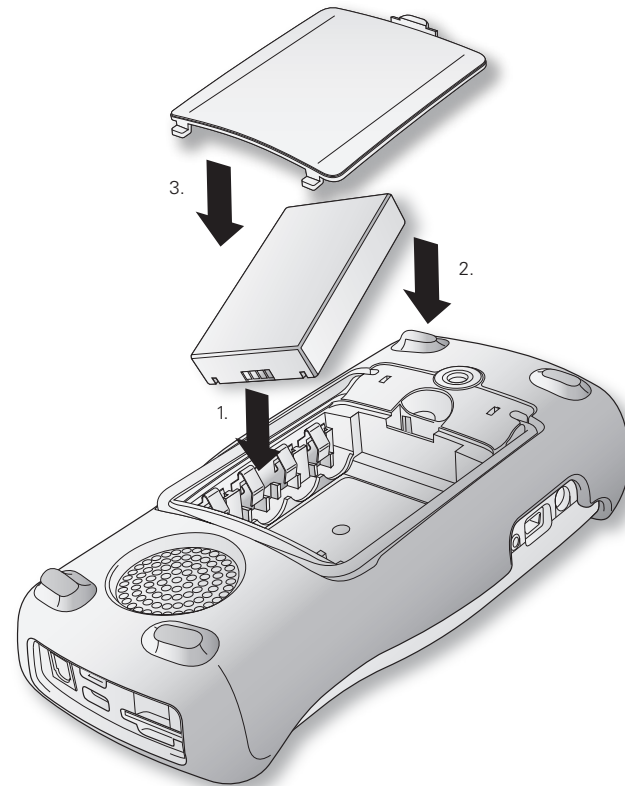

AA-Batteries

Alternatively, the XL2-TA can be powered by AA type batteries

- Open the battery cover.
- Insert 4 fully-charged AA batteries, observing correct polarity of the +/- indications in the battery compartment.

👉 The polarity alternates with successive batteries.

- Close the battery cover.



- Switch the XL2-TA off prior opening the battery cover in order to prevent any electronic discharges.
- Use only similar batteries from the same manufacturer.
- Replace discharged batteries with new ones.
- Do not mix used and new batteries.
- During operation, the battery temperature may increase noticeably. This is not a defect.
- Remove all batteries if the XL2-TA is not to be used over a long period of time.

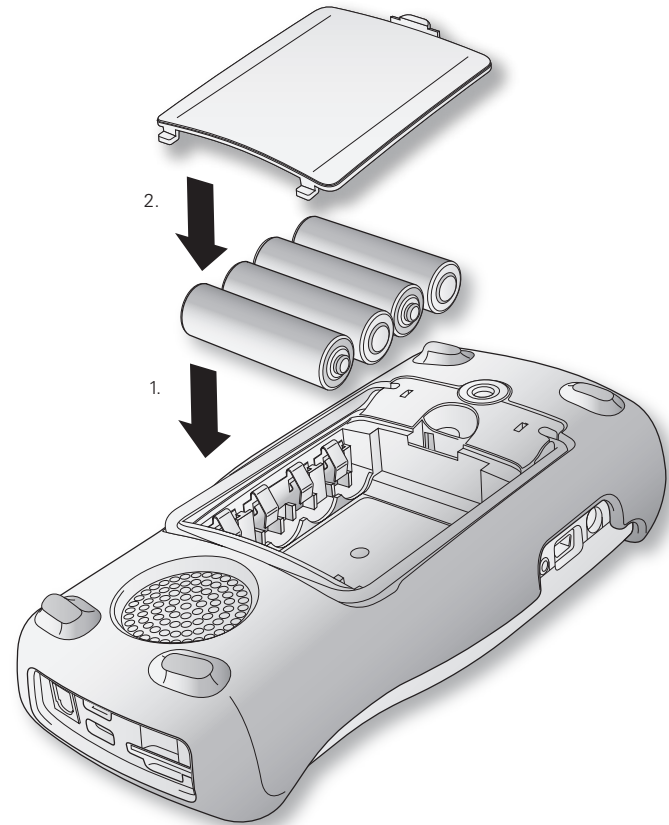

Attaching the Hand Strap

To avoid accidentally dropping the XL2-TA, a hand strap is supplied with the instrument.

- Pull the loop of the hand strap through the opening.
- Pull the other end of the hand strap through the loop.
- Pull the hand strap tight.

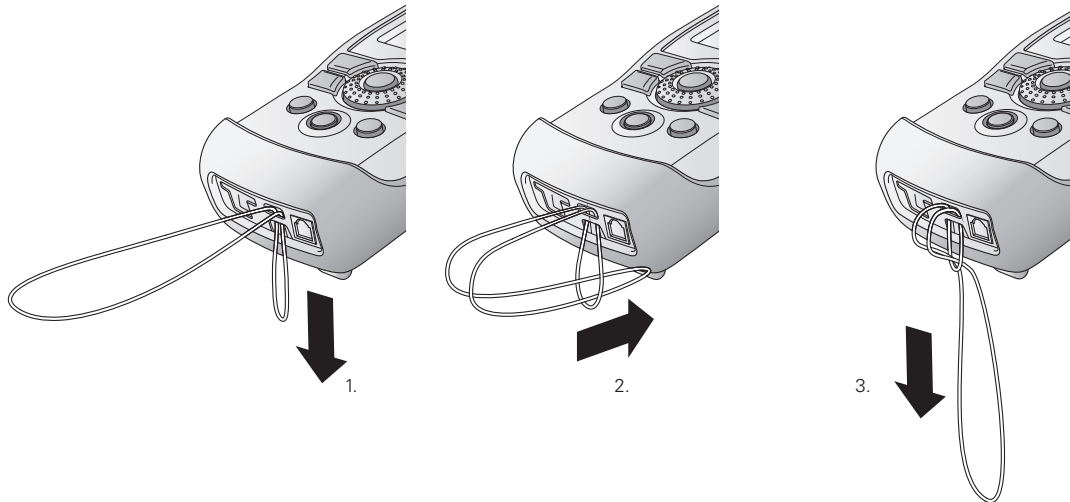

Unfolding the Stand

A convenient table stand is attached to the rear of the instrument.

- Unfold the stand and rest the XL2-TA on a flat surface.

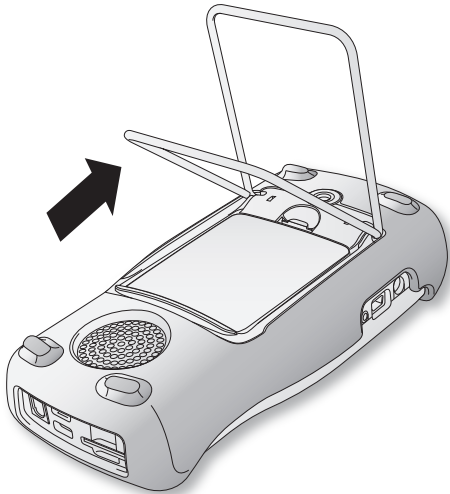

Connecting the XL2-TA

Acoustic Measurements

Connect an NTi Audio measurement microphone to the XLR input connector of the XL2-TA.

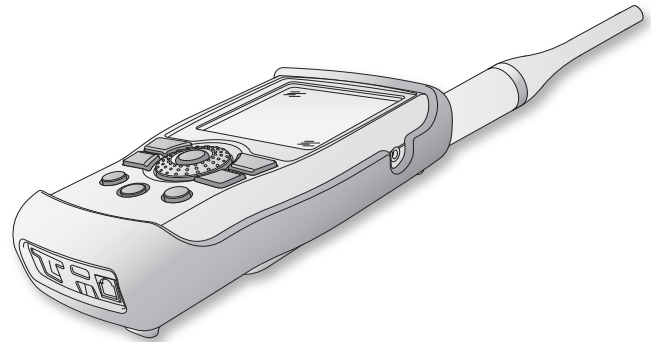

Audio Measurements: XLR Connection

- Connect the source to the XL2-TA with an XLR cable.
- Select the XLR input in the menu.

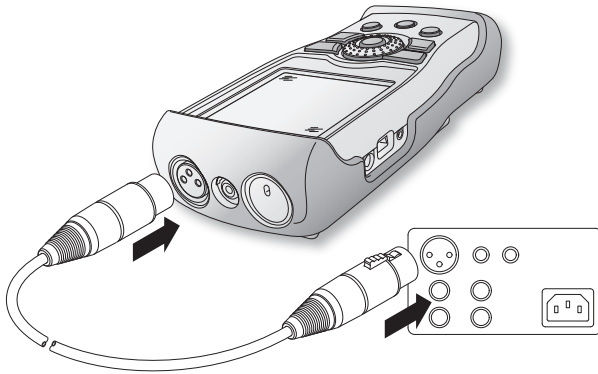

Audio Measurements: RCA Connection

- Connect the source to the XL2-TA with an RCA (cinch) cable.
- Select the RCA input in the menu.

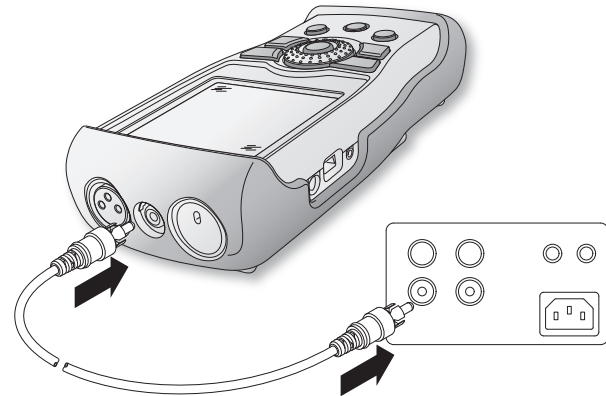

Switching the XL2-TA On and Off

Switching On the XL2-TA

Press power to switch on the XL2-TA.

There is a brief sound of relays and the display illuminates.

Switching Off the XL2-TA

Press power and hold it down for one second to switch off the XL2-TA.

Select Measurement Function

- Navigate with the rotary wheel to the main menu bar.
- Confirm with enter to select the measurement function.

The main menu window opens

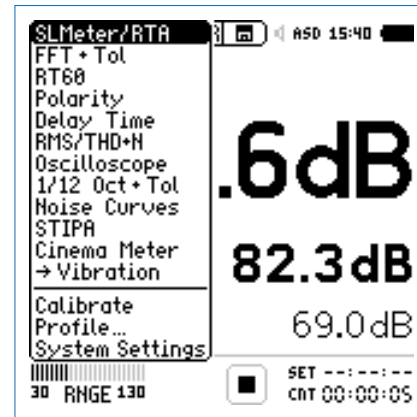

Main menu with enabled options

- Scroll up/down with the rotary wheel to select the required function and confirm with enter .

The measurement function is selected.



Setting the Parameters with the Rotary Wheel

- Turn the rotary wheel  to navigate within the display screen.

 The selected parameter is highlighted with a black background.

- Confirm with enter .

 The parameter display flashes and/or available parameters or settings are shown.

- Turn the rotary wheel  to set the parameter or toggle with enter  through the settings.
- Confirm with enter .

 Now the parameter is set.

Calibration prior Measurement

We recommend the daily calibration of the XL2-TA Analyzer with the Sound Calibrator. This ensures accurate measurement results.

For more details see chapter Calibration.

4. Sound Level Meter

The XL2-TA provides, together with the measurement microphone, a precise sound level meter for monitoring live sound events and/or environmental noise.

The Type Approval Option upgrades the instrument to the XL2-TA, the sound level meter dedicated to certified measurements. The XL2-TA with the M2230 microphone forms a type approved sound level meter offering class 1 performance according IEC61672 (see chapter Options and Accessories)

For example, Actual, Lmin, Lmax, Leq with frequency weighting A, C and Z and time weighting F and S can be measured at the same time. All measurement results are simultaneously available. You may log all acquired level information, including real-time information, onto the removable SD Card. To complete the documentation of the measured sound pressure levels, the XL2-TA offers wav-file recording, as well as the facility to add voice notes for each measurement. The XL2-TA measures correction values between the loudest point of the live event and the actual measurement positions in accordance with DIN 15905-5 and V-NISSG. In parallel with the wide band parameters, the XL2-TA measures the real-time spectrum either in 1/1 or 1/3 octave-band resolution. The RTA perfectly suits tasks such as optimization of sound systems

Extended Acoustic Pack (optional)

The Extended Acoustic Pack offers the following additional features for sound-level and acoustic measurements:

- SLMeter/RTA function
 - Recording of linear wav-files (24 bit, 48 kHz)
 - Percentiles for wide band and spectrum with flexible setting from 0.1% to 99.9%
 - Sound Exposure Level L_{AE}
 - 100 ms logging
 - RTA logging of Lmin and Lmax
 - Event-triggered audio and data recording
 - Time weighting: Impulse (Lxl, Lxleq with x= A, C, Z)
 - True peak level in 1/1 and 1/3 octave resolution
 - Clock-impulse maximum level (TaktMax) in accordance with DIN 45645-1 and DIN 45657
 - Impulsiveness detection in accordance with BS4142:2014 and NordTest ACOU 112
- FFT function
 - High-resolution Zoom-FFT with selectable frequency ranges and resolution up to 0.4 Hz in the range of 5 Hz to 20 kHz
- RT60 function
 - Reverberation time in 1/3 octave resolution
- 1/12 octave Spectral Analyzer (requires Spectral Limits Option)
 - Recording of linear wav-files (24 bit, 48 kHz)

The sound level meter offers different pages:

Page Selection using the Page Button

- Press page  to toggle between the **123 SLMeter** page and the **RTA** page.

Page Selection using the Rotary Wheel

- Select the page **123 SLMeter** with the rotary wheel .
- Confirm with enter .

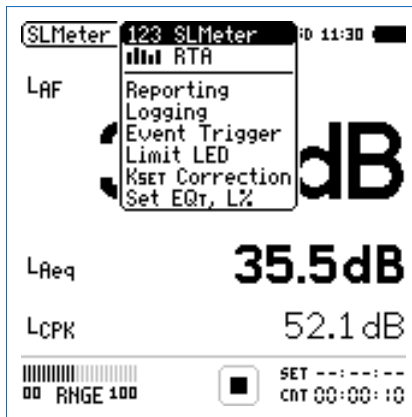

Menu with enabled options

 You have selected the individual sound level meter page.

123 SLMeter: Sound Level Meter

Displays the selected broadband sound level results. You can change the font size of the result. Depending on the font size chosen, the XL2-TA shows 3 or 5 results simultaneously. Individual frequency weighting, time weighting, actual, minimum, maximum and correction values can be chosen for each displayed result.

RTA: Real-Time Spectrum

Displays the 1/3 or 1/1 octave spectrum of the selected sound level within the audio band. Additionally the wide band result is shown graphically by a bar.

Reporting: Report Setting

Here you set which sound pressure levels shall be stored in a .txt file after the completed measurement. Choose between:

- ALL** Stores all sound pressure levels.
- Selected** Stores up to 10 different individually-defined sound pressure levels.

For details refer to the chapter Reporting.

Logging: Setup of Data Logging

The XL2-TA features a powerful sound level meter data logger, which allows you to record all required sound level values during the measurement. In the logging page you set which sound pressure levels shall be logged over time. For details refer to the chapter Logging. Choose between:

- ALL** Logs all sound pressure levels.
- Selected** Logs up to 10 different individually-defined sound pressure levels.

Event Trigger: Event Setting (optional)

The event function is available with the optional Extended Acoustic Pack. The XL2-TA event feature offers the following functionalities:

- Automated event triggered at noise levels above/below a preset value including setting markers for specific noise categories. Application example: Recording the noise level for LAF > 80 dB.
- Event triggered by external key press of the XL2 Input Keypad. You can utilize four keys (1-4) to categorize any noise of interest or noise to be later excluded in the post-processing. A typical application is categorizing any annoying industrial noise by persons living in the neighborhood.

Limit LED: Limit Setting

Here you set the function of the limit LED , thereby highlighting any sound level that exceeds the pre-set limits in orange or red color. Further, external peripherals are controlled by the optional Serial I/O Interface based on the sound level, such as displaying sound levels on a large external red-orange-green lamp. For details refer to the chapter Limits.

KSET Correction: Setup of Correction Values

This page provides a wizard to measure correction values, which could be helpful for compliant sound level monitoring of live events. It measures the correction values between the actual measurement position and the loudest position accessible by the audience. The XL2-TA displays and logs the selected sound pressure levels including the correction values, allowing the sound engineer to monitor the sound level at the loudest position in the audience. The measurement meets the requirements of the standards DIN15905-5 and V-NISSG. For details refer to chapter Correction Value KSET.

Set EQt, L%: Selection of measured levels

This page allows setting the following levels:

- Moving Time-average Sound Level
Gliding Leq with selectable time window from one second to one hour. Four individual levels can be configured. This level is also called “running Leq,T” or “sliding Leq,T”.
- Percentile Sound Level
 - Allows the individual configuration of seven statistic levels from 0.1% to 99.9% (optional with Extended Acoustic Pack).
 - The **Broadband Source** for the calculation of the level statistics can be chosen from a set of different levels with either a frequency weighting A, C or Z. The time weightings F, S and the moving time-averaged sound level for one second are supported.

Overview

Numeric Result Page

The numeric result page **123 SLMeter** displays the selected broadband sound level results. You can change the font size of the result. Depending on the font size chosen, the XL2-TA shows three or five results simultaneously. Individual frequency weighting, time weighting, actual, minimum, maximum and correction values can be chosen for each displayed result.

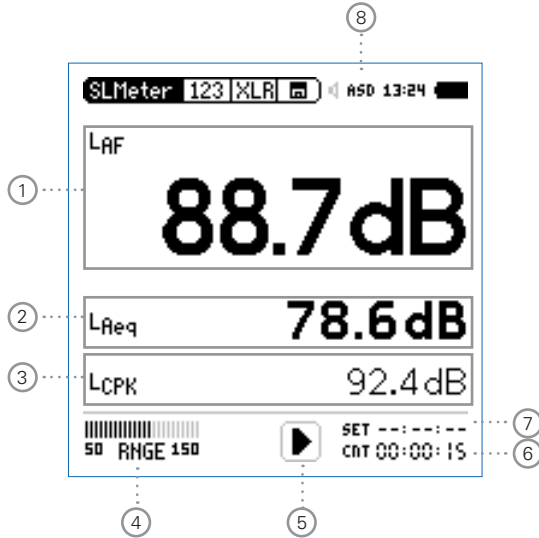

Real-Time Analyzer Page



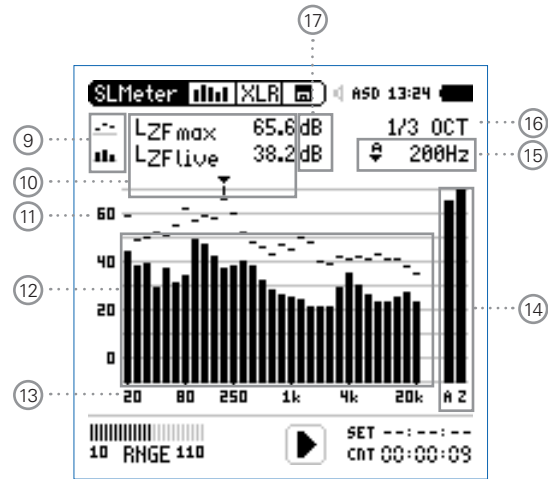

The real-time analyzer page **RTA** measures and displays the 1/3 or 1/1 octave spectrum from 6.3 Hz to 20 kHz including wideband results. The real-time spectrum RTA is measured in parallel with the A and Z-weighted wideband levels.





① Sound Level Result 1

All sound levels are measured and logged simultaneously. You select which sound levels should be displayed.

Change Parameter

- Turn the rotary wheel  to select the parameter **Lxx**.
- Press enter  to open the selection menu and choose the wideband sound pressure level to be displayed.
- Turn the rotary wheel  to select the required test result parameters and confirm with enter .

Change Font Size

- Turn the rotary wheel  to select the actual test result.
- Press enter  1x, 2x or 3x to set the font size to small, medium or large.

The XL2-TA shows 3 sound levels on the display if a large font is chosen, otherwise it shows 5 sound levels.

② Sound Level Result 2 & 3

Follow the setting instructions for sound level result 1.

③ Sound Level Result 4 & 5

To display sound level results 4 & 5, choose a smaller font for all results. Follow the setting instructions for sound level result 1.

④ Input Range

The XL2-TA Analyzer provides three input ranges to accommodate the wide range of input signals. The individual ranges are based on the microphone sensitivity setting in the calibration menu of the XL2-TA. For example, at a sensitivity $S=20\text{mV/Pa}$ the input ranges are

- Low: 10 - 110 dBSPL
- Mid: 30 - 130 dBSPL
- High: 50 - 150 dBSPL

Select the lowest possible input range according to the maximum level expected during the measurement; e.g., if the sound pressure will always be below 110 dBSPL, then select the lowest input range 10 - 110 dBSPL.

⑤ Run Indication

The run indication shows the measurement status running, paused or stopped. Various measurement settings are locked during ongoing measurements, such as changing the input ranging or the preset measurement time.

⑥ Actual Measurement Time

Counts actual measurement time in hrs:min:sec. Supports time modes: continuous, single and (synchronized) repeat.

Timer Mode Continuous

(applicable for standard measurements)

All values are recorded and monitored continuously after starting a measurement with start . The actual measurement time is shown.

Timer Mode Single

Automatically stops the measurement after the pre-set measurement time.

- Set the required measurement time.
- Start the measurement .

 The actual measurement time counts back to zero and the measurement ends.

- All measurement results may be recalled.



Timer Mode Repeat

Provides automated repeated measurements with user-defined, preset measurement time cycles.

- Set the required measurement time.
- Press start .



The actual measurement time counts back to zero. When the preset measurement time has elapsed, the measurement time and the measurement results are reset and a new measurement is started. All measurement results of the previous cycle are reset.

- Press stop  to complete the measurement.



Timer Mode Repeat Synchronized

Provides automated repeated measurements synchronized to the XL2-TA real-time clock. Press start  to begin the measurement. In order to align the selected preset measurement time with the real-time clock, the XL2-TA shortens the first cycle to match the real-time clock synchronization. All following measurement cycles are synchronized to the real-time clock.

For example, the cycle time setting is 30 minutes and the measurement starts at 7.50 a.m. -> the first test cycle measures from 7.50 - 8.00 a.m. Thereafter a new test cycle starts automatically for 30 minutes. The 30-minute cycles repeat until the measurement is stopped.

The measurements in the synchronized repeat timer mode start exactly on the half or full hour in accordance with DIN 15905.

7 Preset Measurement Time

Adjustment of preset measurement time for single and repeat timer setting.

8 Phantom Power Supply

48V The XL2-TA provides 48 V phantom power supply to the connection microphone or sensor.

ASD An NTi Audio measurement microphone with automated sensor detection ASD is connected. The XL2-TA reads the electronic data sheet of the microphone and switches the 48V phantom power automatically on

48V Phantom power is switched off.

9 Result Symbols / Capture

This field offers two functions:

- Symbols for measurement results ¹⁵





Upper RTA parameter displayed as line.



Lower RTA parameter displayed as bargraph.

- Capture



One of the displayed RTA readings may be captured. Any measurement data can then be compared with this captured reference live on the XL2-TA Analyzer. For example, compare the RTA spectrum of the left and right speakers.

- Select the parameter to be captured.
- Confirm with enter , to capture the reading.
- Select the upper RTA parameter  and choose **Capt.**
- Confirm with enter .





 The lower RTA reading can be compared with the previously-captured reference data.

Measurement Result

Actual level result of the indicated frequency band. The cursor readout displays the center frequency and the level of the band pointed to by the arrow.

-  Upper parameter displayed as line.
-  Lower parameter displayed as bargraph.

Y-Scale setting

- Select the Y-Axis with the rotary wheel  and confirm with enter .
- Select the zoom factor between **20, 10, 5, 2.5 dB/div** and confirm with enter .
- Scroll up and down with the rotary wheel  to select the Y-axis range.
- Confirm with enter .





RTA Measurement Result

Real-time analyzer results in 1/1 octave or 1/3 octave band resolution. Adjust the resolution at .

X-Scale setting

Toggles X-scale range between

- 20 Hz - 20 kHz RTA levels including wide band results
- 6.3 Hz - 8 kHz RTA levels including wide band results
- 6.3 Hz - 20 kHz RTA levels

- Select the X-Axis with the rotary wheel  and confirm with enter .
- Toggle with the rotary wheel  between the ranges.
- Confirm with enter .

14 Broadband Results

Actual sound level.

The broadband sound pressure level L_{eq} , L_{min} , L_{max} and Live are displayed here. The Live level is displayed with time weighting Fast.

A A-weighted broadband sound pressure level

Z Broadband sound pressure level without any frequency weighting



15 Readout Frequency

You may select any frequency to read out individual levels. The selected frequency is indicated by the cursor arrow.

Choose between the following settings:



The cursor follows automatically the highest level, e.g. tracing feedback frequencies at live sound.



- Select the frequency with the rotary wheel .
- Press enter .
- You may readout any individual frequency.
- Return to auto frequency with enter .



The cursor returns to the frequency with highest level bar.



The cursor readout may be set manually to any frequency band or wide band level. The readout remains at the selected frequency.



- Select the frequency with the rotary wheel .
- Press enter .
- Select the frequency of interest.
- Confirm with enter .



The cursor readout  displays the measurement results of the selected frequency band.

16 Setting of Test Result Resolution

Set the RTA result display to 1/1 octave or 1/3 octave band resolution as follows:

- Turn the rotary wheel  to select the parameter .
- Press enter  to toggle between **1/1 OCT** and **1/3 OCT** and set this parameter.

17 Measurement Unit

Select the measurement unit as follows:

- dB** Sound level in dBSPL
This measurement unit is permanently selected when an NTi Audio measurement microphone with electronic data sheet is connected.
- dBu** Input level in dBu
- dBV** Input level in dBV
- V** Input level in Volt

- The measured sound pressure level is just above the residual noise of the connected NTi Audio measurement microphone. This reduces the measurement accuracy -> choose another microphone designed for low level measurements.

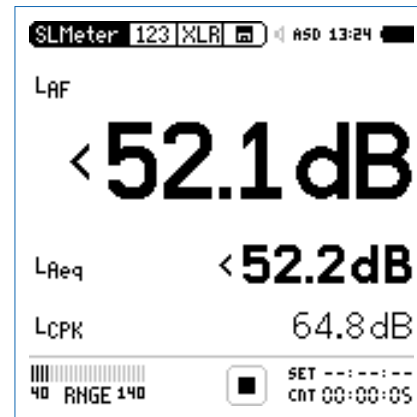



LOW - Indication

The low indicator for an individual level “<” is displayed when:

- The measured sound pressure level is below the selected linear measurement range. In this case the results shown are most likely higher than the actual sound pressure level -> choose the next lower measurement range.

The low condition is registered in the log and report files in the column “Low(eq/peak)” individually for all frequency weightings, the RMS and the peak levels.

Overload Indication

In case the measurement result exceeds the preset measurement range, then limit arrows  indicate this overload condition. The arrows  are displayed for as long as the overload exists, and at least for a minimum of 1 second. Furthermore, such an overload condition triggers the **OVR** indication in the bottom line, which remains displayed for the complete measurement period. These overload indications are reset at the start of a new measurement. All overload conditions are registered in the log and report files.

Possible causes for exceeding measurement ranges are

- The measured sound pressure level exceeds the pre-set measurement range during the measurement period. Once this happens, the **OVR** indication remains displayed for the complete measurement period -> select the next higher measurement range or reduce the input signal level as applicable.
- The input level is near the maximum level of the connected NTi Audio measurement microphone.

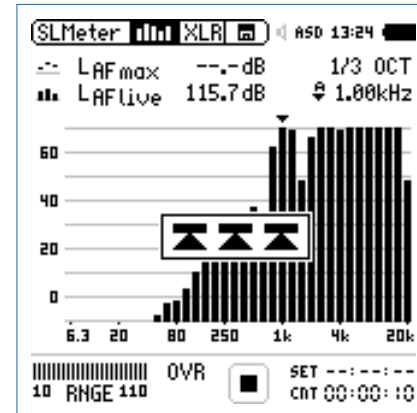
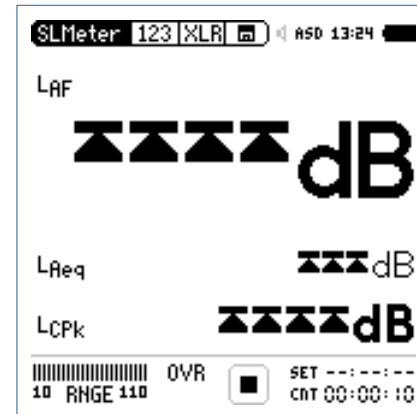

Sound Level Meter - Getting Started

Test Preparations

- Connect the measurement microphone to the XL2-TA.
- Switch on the XL2-TA

The XL2-TA reads the electronic data sheet of any connected NTi Audio ASD microphone and switches the 48V phantom power automatically.

The 48V phantom power indication in the upper menu bar changes to ASD. The **XL2-TA** is ready for acoustic measurements.

- Position the XL2-TA at the measurement location using a microphone stand or a tripod.
- Select the **SLMeter** function in the measurement menu and toggle with page to the numeric result page **123**.

All wideband and RTA levels are measured and logged simultaneously. You select which sound levels should be displayed.

Select Displayed Test Result

This example describes the setting of the commonly-used actual sound pressure level L_{AF} (level L, frequency weighting A, time weighting F).

- Select the first parameter setting with the rotary wheel .
- Confirm with enter .

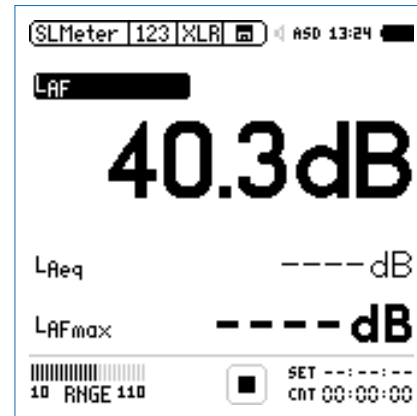

Press start to measure and display the sound levels results indicated with ----.

Select Frequency Weighting

👉 The pop-up window **FREQ WEIGHTING** appears.

- Select the frequency weighting **A**.

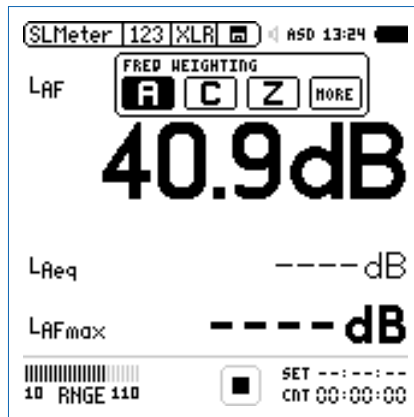

Installation of the Extended Acoustic Option adds more items to the pop-up window

- Confirm with enter

Select Time Weighting

👉 The pop-up window extends with **TIME WEIGHTING**.

- Select the required time weighting; e.g. **F** (=Fast).

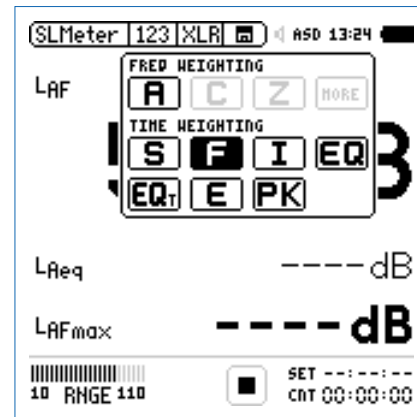

- Confirm with enter

Select Parameter

👉 The pop-up window extends with **PARAMETER** settings.

- Select the parameter **live**.

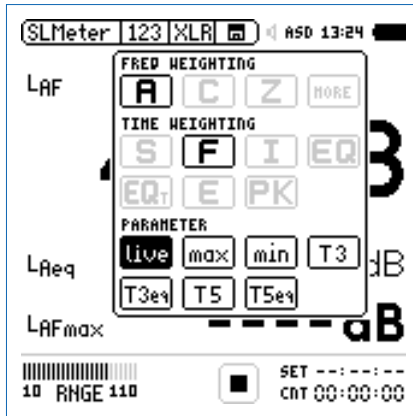

- Confirm with enter ↵.

Select Correction Value

👉 The pop-up window extends with **CORRECTION** settings.

- Select the parameter **off**.

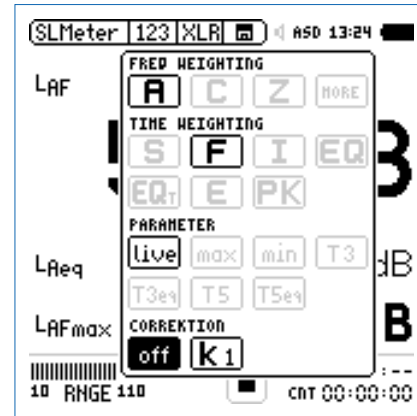

- Confirm with enter ↵.

👉 The pop-up window closes and the measured sound pressure level L_{AF} is displayed.

Select further Sound Levels



- Select further sound pressure levels as described above; e.g., L_{Aeq} and L_{AFmax}

Select Input Range

- Select the lowest possible input range based on the maximum level expected during the measurement. Wrong input ranges are indicated by a “<” in front of the measurement value or a flashing **OVR** message in the lower menu bar.
- Select the input range **RNGE** and press enter ↵.
- Turn the rotary wheel ⌚ to set the applicable input range and confirm with enter ↵.



The numeric result page and the real-time analyzer page use the same input range.

Start Measurement

- The XL2-TA is ready to measure the sound levels L_{AF} , L_{Aeq} and L_{AFmax} .
- Press start

👉 The run indication switches to running . The integrated sound pressure level over time L_{Aeq} and the maximum level in the measurement period L_{AFmax} are displayed. The parameter **RUN**, **LOG** (logging is enabled) or **AUD** (audio recording is configured) flashes in the memory menu.

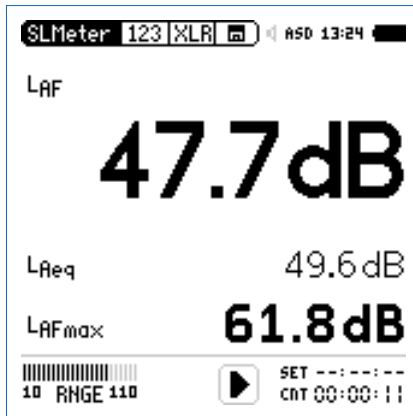

Stop Measurement and Data Saving

- Press stop .

👉 The XL2-TA stores the broadband sound pressure levels and the real-time analyzer results simultaneously.



- Press enter to confirm. The measurement data is stored on the SD Card in ASCII format.

👉 The sound pressure level measurement is completed.

Data Post-Processing

The XL2-TA stores all data and audio onto the SD card for direct transfer to a computer. Audio data is stored as .wav files. Data reports and log files are stored in plain text format, which can be opened with any text editor (Notepad, Wordpad, etc.). The data is tab-delimited, so dropping the .txt file into a spreadsheet application will conveniently show the results in columns.

Furthermore, a series of free MS Excel application templates provide a convenient way to view the measurement results of specific tasks and create simple reports. They are available as free download for all registered XL2-TA customers on the support website at <https://my.nti-audio.com>. (Enable all macros when opening the document.)

For the most comprehensive analysis of logged noise monitoring data, use the XL2 Data Explorer software. The data import into the software is enabled by the Data Explorer Option, which needs to be installed in the XL2-TA Sound Level Meter. More details in chapter XL2 Data Explorer.



RTA Measurement - Getting Started

Test Preparations

The XL2-TA reads the electronic data sheet of any connected ASD microphones provided by NTi Audio and switches the 48V phantom power automatically on as follows:

- Connect the measurement microphone to the XL2-TA.
- Switch on the XL2-TA .

 The 48V phantom power indication in the upper menu bar changes to ASD. The **XL2-TA** is ready for acoustic measurements.



- Position the XL2-TA at the measurement location using a microphone stand or tripod.
- Select the **SLMeter** function in the measurement menu and toggle with page  to the real-time analyzer (RTA) page .





All wideband and RTA levels are measured and logged simultaneously. You select the sound levels to be displayed.

RTA Configuration

The XL2-TA displays two different sound pressure levels at the same time. You configure which test results to display; e.g., LZFmax and LZFlive.

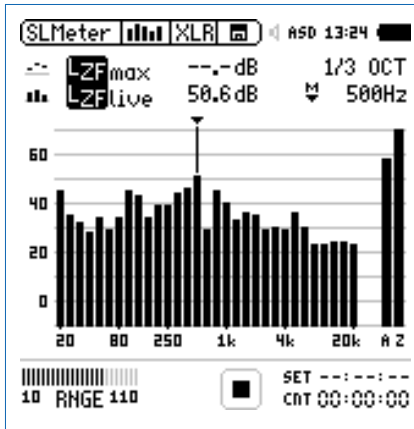
- Ensure no other measurement is going on. The run indication should display the stop symbol .
- Select the **LZF** value with the rotary wheel .





- Confirm with enter .

Select RTA Frequency Weighting

 The pop-up window **FREQ WEIGHTING** appears.

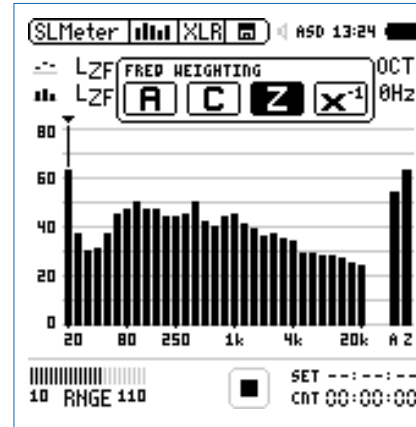
- Select the frequency weighting **Z**.



- Confirm with enter .



Press start  to measure and display the sound levels results indicated with ----.

Select RTA Time Weighting

- 👉 The pop-up window extends with **TIME WEIGHTING**.
- Select the required time weighting; e.g., **F** (=Fast).

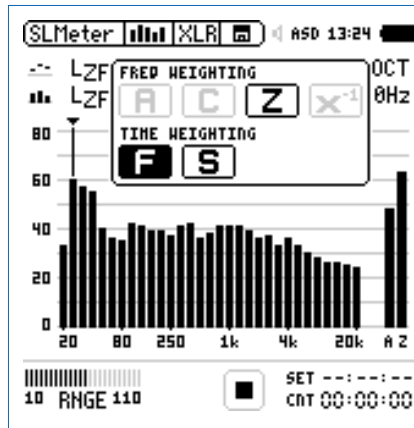

- Confirm with enter ↵.

Select Upper/Lower RTA Parameter

- Select the parameter shown to the right of the upper **LZF** value with the rotary wheel ⌚; e.g. **max**.
- Press enter ↵.

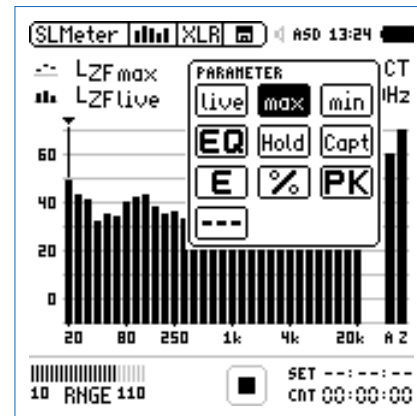

👉 The pop-up window **PARAMETER** appears.

- Select the parameter **max**.



- Confirm with enter ↵.
- Follow the same instruction and select the lower RTA parameter **live**.

Select Input Range



- Select the lowest possible input range according to the maximum level expected during the measurement. Wrong input ranges are indicated by a < in front of the measurement value or a flashing **OVR** message in the lower menu bar.
- Select the input range **RNGE** and press enter .
- Turn the rotary wheel  to set the applicable input range and confirm with enter .



The numeric result page and the real-time analyzer page use the same input range.

Start RTA Measurement

- The XL2-TA is ready to display the measured sound pressure levels L_{ZFmax} and L_{ZFlive} .
- Press start .

 The run indication switches to running . The actual sound level L_{ZFlive} and the maximum level L_{AFmax} are displayed. The parameter **RUN**, **LOG** (logging is enabled) or **AUD** (audio recording is configured) flashes in the memory menu.

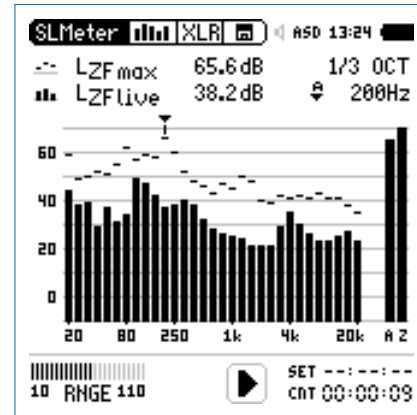

Stop the Measurement and Data Saving

- Press stop .

 The XL2-TA stores the broadband sound pressure levels and the real-time analyzer results simultaneously.

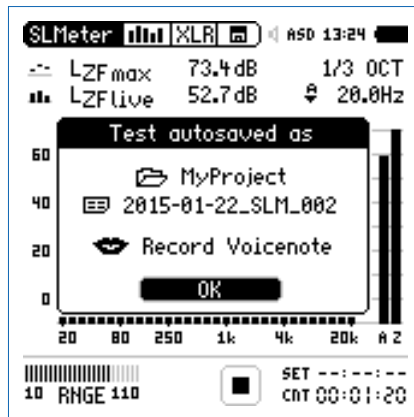

- Press enter  to confirm. The measurement data is stored on the SD Card in ASCII format.

 The RTA measurement is completed.

Reporting

A report saves the conducted measurements onto the installed SD Card. The XL2-TA Supports setting the individual levels to be stored in the report after the measurement is completed.

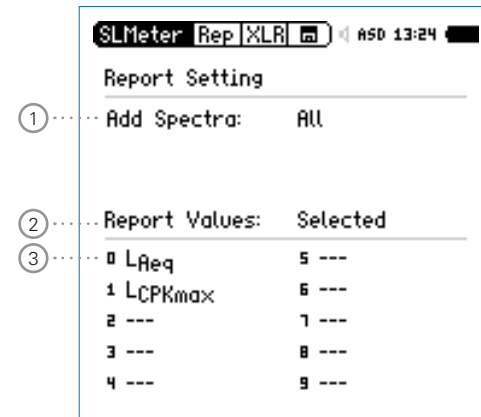

① Add Spectra

No

No RTA measurement reporting.

Leq

The RTA Leq level is stored in the report.

Leq, Lmax, Lmin The RTA Leq, Lmin, Lmax levels are stored in the report.



All All RTA levels are stored in the report.

② Report Values



Choose between the following result reporting:

ALL Records all available sound pressure levels without correction values.



Selected Records a subset of up to 10 different levels, including correction values if you require.

- Select **Report Values** with the rotary wheel .
- Press enter  to toggle between **All** or **Selected**.

③ Selected Report Values

- By setting **Selected** at ② up to 10 individual report values can be chosen. Select the first value **Lxx** with the rotary wheel  and press enter .

 The pop-up window for level selection appears.



- Select the reporting level with the rotary wheel  and confirm with enter .

Logging

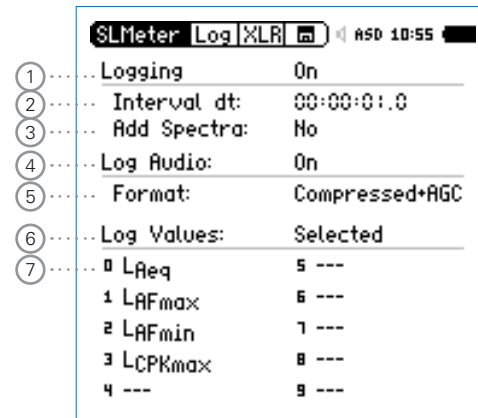
The XL2-TA features a powerful sound level meter data logger, which allows you to record all required sound level values during the selected period of time. All results are logged onto the SD Card. The measurement results can be loaded to a PC for documentation and visualization. The LOG menu offers the detailed setup of the log report.



① Logging

Select **Logging** with the rotary wheel  and press enter  to enable the automated logging of test results.

On The XL2-TA logs measurement data every interval dt .

Off No Logging

② Interval Δt

Adjust the logging interval. The optional Extended Acoustic Pack offers the additional 100 ms logging.

③ Add Spectra

Set the RTA logging for each logging interval here.

No No RTA spectrum is logged.

Leq The Leq spectrum is logged.

Leq, Lmax, Lmin The Leq, Lmax and Lmin spectrum is logged simultaneously (requires optional Extended Acoustic Pack).

④ Log Audio

The XL2-TA logs audio data as a wav-file. Choose among the following settings:

Off Audio logging is off

On Audio logging is activate from measurement start to stop.

Events Only Audio logging of triggered events only.

For more details read the chapters Wav-File Recording and Events.

⑤ Format

Choose among the following audio recording settings:

Compressed Compressed audio logging

Compressed+AGC Compressed audio logging with automated gain control



24Bit_48kHz Linear audio logging in 24 bit, 48 kHz resolution (optional with Extended Acoustic Pack)

⑥ Log Value Setting

Choose between the following settings:



ALL Logs all available sound pressure levels without correction values.

Selected Logs a subset of up to 10 different sound pressure levels, including correction values if you require.



- Select **Log Values** with the rotary wheel .
- Press enter  to toggle between **All** and **Selected**.

⑦ Selected Log Values

By setting **Selected** at  up to 10 individual log values can be chosen.

- Select the first value **Lxx** with the rotary wheel  and press enter .

 The pop-up window for level selection appears.

- Select the logging level with the rotary wheel  and confirm with enter .

At 100ms Logging is the log value selection limited to five different parameters.

Wav-File Recording

The XL2-TA records a wav-file of the measured input signal and stores it on the SD Card. The available formats are:

- **Compressed** (default, using ADPCM compression). A new wav-file is started automatically after 12 hours of recording (typical maximum wav-file size = 512 MByte)
- **Compressed+AGC**, compressed with automated gain control. The gain control increases the level of low-level signals, so that the wav-file is well-leveled during playback on the PC.
- **24Bit_48kHz**, linear wav-file logging in 24 bit, 48kHz resolution with the optional Extended Acoustic Pack. A new wav-file is started automatically after 1 hour of recording (typical maximum wav-file size = 512 MByte)



Broadcast Wave Format BWF

The XL2-TA stores scaling factor, serial number, date, time and time zone within the wav-file (according to EBU TECH 3285). This information is available through professional audio/video tools typically used in broadcast.

Sample name of wav-file:

MyTest_SLM_000_Audio_FS133.0dB(PK)_00.wav



- ① **MyTest**
File name defined by user.
- ② **SLM**
Measurement function.
- ③ **000**
Automatically incrementing file number.
- ④ **Audio_FS133.0dB(PK)**
Audio file with full scale peak level. In case of a **Compressed + AGC** recording, the file name reads "AGC"; this file contains corrected level information only.
- ⑤ **00**
For wav-file recording over longer periods, the XL2-TA splits the audio data into individual wav-files with about 500 MB (compressed audio: 12 hours; linear: 1 hour), keeping the file size small for easier handling on the PC. The number ⑤ increments for each successive wav-file.

The advantage of wav-file recordings is to identify and document sound sources after the measurement. For example, at a live event an excessive peak level may have been measured and logged. Actually, this peak level was caused by people shouting nearby the measurement microphone, and not by the audio system being monitored. The recorded wav-file assists in verifying this and the test results can then be post-processed.



Pausing Measurement

If any ongoing measurement is paused , the XL2-TA continues the recording of wav-files during the paused period. The logged data and audio data can be synchronized using the stored real-time information.

Events

The wav-files are stored in a folder, named, for example, 2011-11-30_SLM_000_AudioEvent_0001-0200. The actual wav-files are named for example, as xxxx_FS133.0dB(PK).wav (xxxx = incrementing number)

Another example is environmental noise monitoring: Listening to the recorded wav-file after the measurement may help to determine the predominant sound source. The XL2-TA Analyzer preserves the original absolute test signal level in the recorded wav-file.

The XL2-TA Analyzer provides three input ranges to accommodate the wide range of input signals. The dynamic range of the recorded wav-file is set according to the selected input range. For example, at a microphone sensitivity of $S = 20 \text{ mV/Pa}$, the full-scale peak level is:

Range Name	Range Level	Full-scale peak level
Low	10 - 110 dBSPL	117.8 dBSPL
Mid	30 - 130 dBSPL	135.9 dBSPL
High	50 - 150 dBSPL	159.9 dBSPL



Select the lowest possible input range according to the maximum level expected during the measurement; e.g., If the sound pressure will always be below 110 dBSPL, select the lowest input range 10 - 110 dBSPL.

Events (optional)

The event function is available with the XL2-TA Extended Acoustic Pack Option. The XL2-TA Analyzer may be configured to record wav-files and additional noise levels only when triggered, instead of the complete measurement duration.

Advantages

Reduces the data volume acquired, thereby

- Simplifying data post-processing
- Saving memory for long-term measurement applications.

Events

Events are triggered either automatically by sound levels above/below a preset value or manually by external key press using the XL2 Input Keypad.



Data Logging

The XL2-TA Analyzer logs the data specified in the LOG setting for the complete measurement duration into a log file. The markers and triggered events results are added to the same log file. The XL2 Input Keypad is available as an accessory. Please see chapter Options and Accessories for details.

Recommendation

With the large storage capacity of the XL2-TA, NTi Audio recommends logging at a 1 second or faster interval. This allows the accurate collection of event data; one event will be stored within a logged interval. If results for reporting are required at longer intervals, e.g. one hour, the XL2 Data Explorer software is recommended. It easily combines logged data into longer audit intervals. An additional advantage of a faster logging interval is that only an entire logged interval can be excluded from the average. This is useful when a qualified noise consultant judges that a sound is not caused by the object under test or is not a normal sound for a measurement location.

Functions

The XL2-TA event feature offers the following functionalities:

- Automated event triggered at noise levels above/below a preset value including setting markers for specific noise categories. Application example: Recording the noise level for LAF > 80 dB.
- Event triggered by external key press of the XL2 Input Keypad. You can utilize four keys (1-4) to categorize any noise of interest or noise to be later excluded in the post-processing. A typical application is categorizing any annoying industrial noise by persons living in the neighborhood.

Trigger Events: on level above/below

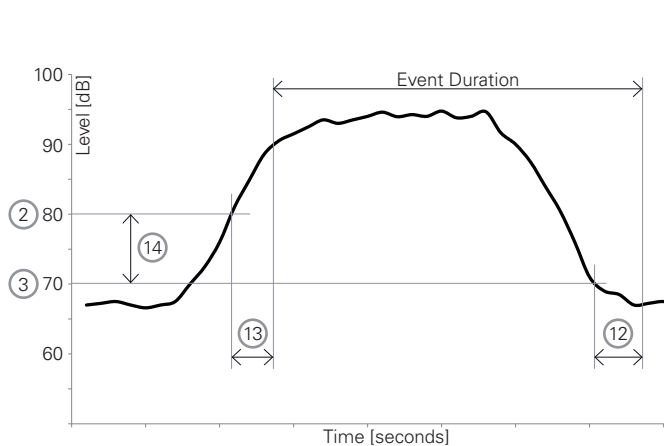

```

SLMeter Evt XLR [ ] 14:00 12:21
1 Trigger Events: on level above...
2 Start [dB]: 80.0 for 02s
3 Stop [dB]: 80.0 - 10 for 03s
4 Level = LAF
5 Log Audio: Events Only
6 Format: Compressed
7 Record whole event
8 Status: Stopped
9 Curr Level = 64.5dB MONITOR
10 Event count: 0000 Lvl1234
  
```

Features:

- The levels L_{Aeq} , L_{Zeq} and L_{Cpeak} are recorded for the event duration.
- Audio data is recorded for the triggered event duration only, thus simplifying data post-processing and saving memory space for long-term measurements.
- Setting markers by external key press of the XL2 Input Keypad.

① Trigger Events

Choose from the following settings:

- Off** No event triggering
- on level above** Events are triggered at noise levels above the preset value ② for the start duration ⑬.
- on level below** Events are triggered at noise levels below the preset value ② for the start duration ⑬.
- on ext. key press** Events are triggered by external key press.

② Start [dB]

Set the level at which the triggered event is started.

Start Duration ⑬

The event start is triggered when the noise level is higher (or lower) than the preset value and continues for the preset duration.

③ Stop [dB]

Set the level at which the triggered event is stopped.

on level above Stop level = Start level ② - Hysteresis ⑭

on level below Stop level = Start level ② + Hysteresis ⑭

Stop Duration ⑫

The event stop is triggered when the noise level is lower (or higher) than the preset value and continues for the preset duration.

Hysteresis ⑭

Set the hysteresis to an appropriate value to prevent rapid switching on and off as the level drifts around the Start level.

④ Level Selection

Define the level type to be monitored.

5 Log Audio

The XL2-TA logs audio data as a wav-file. Choose from the following settings:

Off	Audio logging is off
On	Audio logging is activated from measurement start to stop.
Events Only	Audio logging of triggered events only.

For more details read the chapter Wav-File Recording.

6 Format

Choose from the following audio recording formats:

Compressed	Compressed audio logging
Compressed+AGC	Compressed audio logging with Automated Gain Control (AGC)
24Bit_48kHz	Linear audio logging in 24 bit, 48 kHz resolution. (Required for post-processing on the PC with Extended Acoustic Pack)

7 Audio Logging Period

If **Log Audio** 5 is set to **Events Only**, then the duration for the audio recording may be further specified:

Recording whole event	Records a wav-file for the whole triggered event duration.
Stop recording after	Records a wav-file for the specified period after the event start is triggered.

8 Status Information

Displays current trigger status:

- **Waiting for trigger**
- **Armed** (during start duration 13)
- **Audio + data recording**
- **Completing log cycle**

9 Actual Level

Measurement result of the defined level 4.

10 Event Counter

Counts the number of triggered events that have occurred during the ongoing measurement.

11 Trigger and Marker Monitor

Answers the question: What caused the triggered event?

Lvl Event automatically triggered by level.

- 1 Event triggered or marker added by pressing key 1 of the XL2 Input Keypad.
- 2 Event triggered or marker added by pressing key 2 of the XL2 Input Keypad.
- 3 Event triggered or marker added by pressing key 3 of the XL2 Input Keypad.
- 4 Event triggered or marker added by pressing key 4 of the XL2 Input Keypad.

12 Stop Duration

See 3.

13 Start Duration

See 2.

14 Hysteresis

See 3.

Trigger Events: on external key press

Trigger Events by pressing a button on the external input keypad with automated or manual stop of the event.

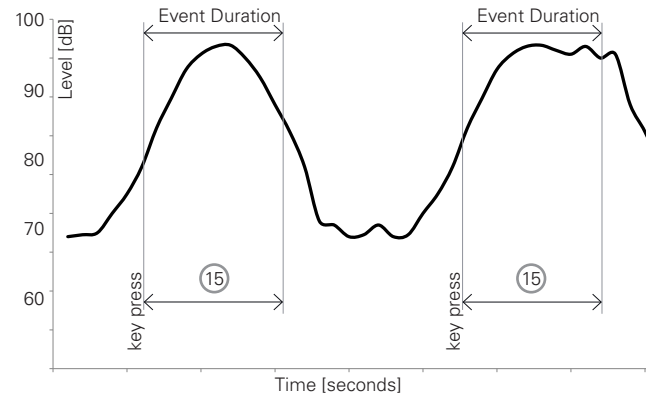

Features:

- The levels L_{Aeq} , L_{Zeq} and L_{Cpeak} are recorded for the event duration.
- Audio data may be recorded for the user-defined event duration 15 after the key press.
- Retrigger with every repeated key press within the event duration.

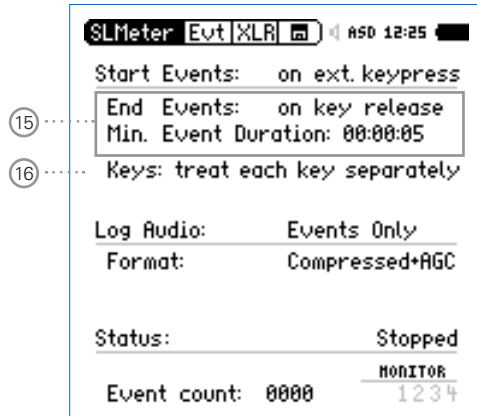

15 Event Stop Mode and Event Duration

on key release

The event is recorded as long as the button of the input keypad is kept pressed; the Event period is at least **Min. Event Duration** long.

on ext. key-press

The event is stopped by pressing a button on the external input keypad; the Event period is at most **Max. Event Duration** long.

16 Button Functionality of Input Keypad

treat each key separately

All four buttons operate individually. For example pressing the button 2 will be recorded as button 2 in the measurement report. This allows you to distinguish different acoustic noise sources.

treat all keys as Key 1

All four buttons operate in parallel and any button press will be recorded as button 1 in the measurement report.

How to Setup the XL2-TA for Triggered Event Measurements

- Select the logging page, set **Logging On, Interval dt: 00:00:01** and choose the required log values.
- Setup the event page. For example, the screenshot below starts the event recording after L_{AF} exceeds 80 dB for 2 seconds and stops after L_{AF} is lower than 70 dB for 3 seconds.



- Select the memory menu and create a new folder. This folder will then be displayed in the memory menu. All log data and event wav-files are stored in this folder.

👉 The XL2-TA is ready for the triggered event measurement.



Logging Enabled

Triggered-event recording requires the activation of sound level logging. Using the default **Interval dt: 1 second** is recommended.

Auto Save

If **Log Audio** ⑤ is set to **Events Only**, then the XL2-TA sets per default **Naming+Saving: auto** in the memory menu. This ensures that the recorded triggered event data is stored on the SD Card.

For convenience, in case more than 20 triggered events have been recorded, the **Auto-save** -> **Delete** function is disabled, as deleting such multiple wav-files on the XL2-TA is time-consuming.

Wav-files

All triggered-event wav-files are stored in an individual folder. For details see chapter Logging.

Limits

The limit page offers two functions:

- Setup of limit LED function; enabling the XL2-TA to high-light any sound levels that exceed the pre-set limit in orange or red color. The default color is green.
- Limit parameter setup for external connected accessories, such as the Digital I/O Adapter PCB, the Limit Light or the Stack Light. These accessories connect to the digital I/O interface of the XL2-TA.

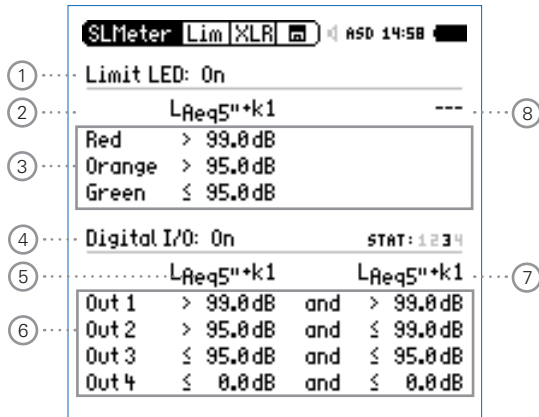

1 Limit LED On/Off

Select **Limit LED** with the rotary wheel and press enter to enable/disable the limit function.

2 LED - Level 1

Select one sound level for the limit LED indication .

- Select the sound level field with the rotary wheel .
- Press enter and select the sound level for the limit LED indication.

3 Selected Level Values

To set the level values for the limit LED ,



- Select the Red or Orange sound level with the rotary wheel and press enter .
- Set the level value with the rotary wheel and confirm with enter .

4 Digital I/O On/Off

Select **Digital I/O** with the rotary wheel and press enter to enable/disable the operation of externally connected accessories.





5 I/O - Level 1

Setup of the level type 1, which is used to trigger externally connected accessories.

- Select the level field with the rotary wheel .
- Press enter  and select the level for the control of the external accessory.

6 Selected Sound Level Values

To set the level values for the control of the externally connected accessory.

- Select the Out 1, Out 2, Out 3 or Out 4 level with the rotary wheel  and press enter . The Limit Light and the Stack Light use **Out 1** for red, **Out 2** for yellow and **Out 3** for green light.
- Set the level value with the rotary wheel  and confirm with enter .

7 I/O - Level 2

Follow the setting for I/O - Level 1. The I/O level 1 may be combined with I/O level 2 using and/or combinations, providing indications in level ranges. Alternatively, other levels can be selected for the control of the externally connected accessories.

8 LED - Level 2

Follow the setting for LED - Level 1.



I/O Limits with Triggered Events

If event recording is enabled, the digital output 4 (**Out 4**) is utilized, e.g. as confirmation feedback to the XL2 Input Keypad. Therefore the limit setting of **Out 4** is disabled.

Correction Value KSET

The correction value page offers a measurement wizard for live event monitoring, applicable in case the measurement location differs from the loudest position in the live event area.

Measurement Position

The goal at live event monitoring is to measure the sound level at the loudest position accessible by the audience. Setting up any sound level measurement at this loudest location is typically not practical, thus an alternative measurement position is chosen. The recommended measurement position in order to minimize the influence that audience noise has on the measurement:

- Mount the measurement microphone in front of the main speakers
- Position the XL2-TA Analyzer at front of house (FOH)
- Connect the XL2-TA Analyzer and measurement microphone using a professional audio cable



Positioning the measurement microphone at front of house (FOH) may result in audience noise interfering with the measurement results. The audience noise will be further amplified by the measured k-values.

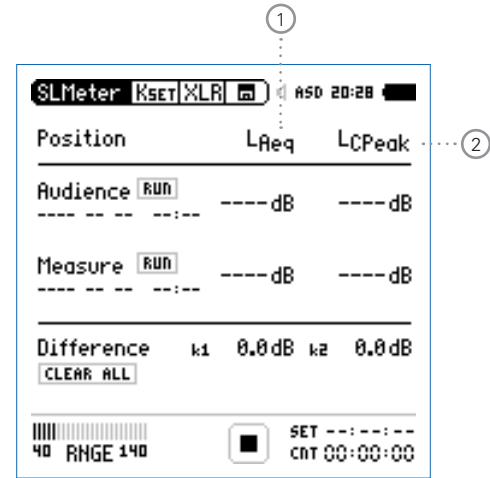

① Correction k1

The correction k1 is based on the LAeq.

② Correction k2

Select the level type for correction k2.

LCpeak for Germany DIN15905-5;
correction is based on LCpeak measurement

LCeq correction is based on LCeq measurement

Level Difference

Prior to the start of the live event, the level difference between the loudest and the measurement position is measured. The XL2-TA Analyzer calculates the level difference automatically based on the individual sound level measurements at both locations. This level difference is included in the sound level reading during the live event, and the XL2-TA thereby displays and records the sound pressure level of the loudest point.

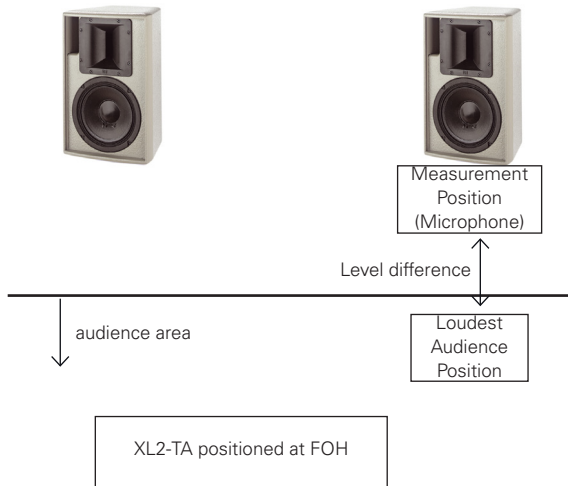

How to Measure the Correction Value

- Play a pink noise signal at the typical sound pressure level of the live event (signal source: Minirator, NTi Audio Test CD or USB Flash Drive)
- Select the correction page **KSET**.
- Search the audience area for the location with the highest sound pressure level and position the XL2-TA Analyzer.
- Turn the rotary wheel to select the parameter **RUN** next to **Audience** and press enter .

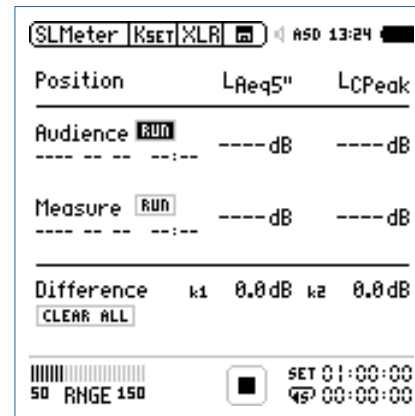

- The XL2-TA measures the sound level at the loudest position for 5 seconds. The timer counts down to zero.

- Wait until the measurement is completed.
- Position the XL2-TA at the measurement position.
- Turn the rotary wheel to select the parameter **RUN** next to **Measure** and press enter .

- Wait until the measurement is completed.
- The correction values k1 and k2 are calculated and displayed including date and time.

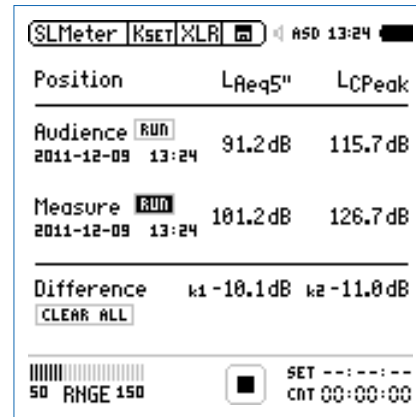
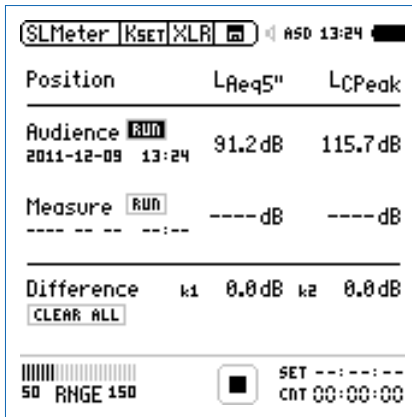

The XL2-TA measures the sound level at the measurement position for 5 seconds. The timer counts down to zero.

Manual Setting of Correction Values

You may fine-tune the correction values k1 and k2 manually. Such fine-tuning adds the remark "Manually Adjusted" in the log file.

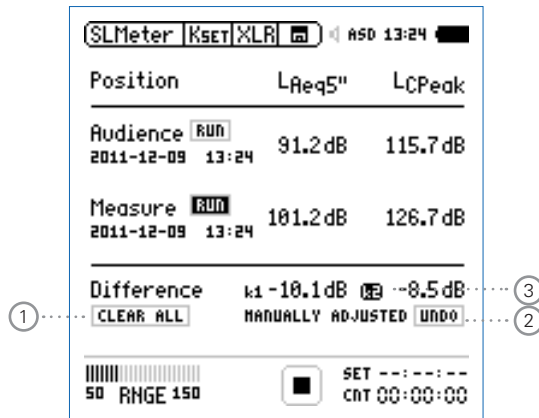

- Turn the rotary wheel to select the correction value and press enter .

The selected correction value starts flashing.

- Set the correction value with the rotary wheel .

The note "Manually Adjusted" is displayed at .

- To undo the manual setting turn the rotary wheel to select the parameter **UNDO** at .
- Confirm with enter .



Reset Correction Values

You may clear all correction values back to zero by pressing the **Clear All** and confirm with enter .

Display k1 and k2 during Measurement

The correction values k1 and k2 can be displayed in the numeric result page during the ongoing sound level measurement instead of any other sound levels.

Correction Values in Profiles

The correction values k1 and k2 can optionally be stored within profiles. Loading the profile, sets the stored correction values.

Locked Run Mode

The Locked Run Mode simplifies sound level monitoring. You just need to power up the XL2-TA and the measurement starts automatically. The measurement continues until you switch off the instrument using the power button . The measurement data is stored by default.

Start Locked Run Mode

- Set the required parameters in the sound level meter for your noise monitoring application.
- Press and hold the start/stop button for 3 seconds.

The Locked Run Mode is now activated. The Run Indicator displays **L**. The **Info** window is displayed at the same time.

- Switch off the instrument.

The measurement is stopped and the data is saved.

- Switch on the instrument.

The sound level measurement starts automatically and continues as long as the device is powered on.

- The page button allows toggling between the sound level meter and real time analyzer window. All other buttons are deactivated during Locked Run Mode.

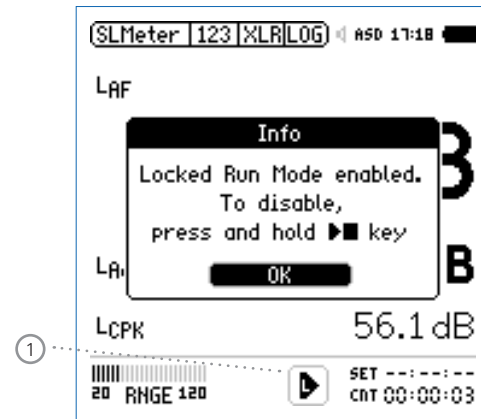

End Locked Run Mode

- Press and hold the start/stop button for 3 seconds during the ongoing measurement.

The measurement is stopped and the Locked Run Mode deactivated.

5. Acoustic Analyzer

Besides the comprehensive sound level meter functions, the XL2-TA Audio and Acoustic Analyzer offers the following acoustic measurement functions:

- FFT Analysis with optional tolerance function
- Reverberation Time
- Polarity
- Delay time
- 1/12 Octave + Tolerance Analysis (optional)
- Noise Curves (optional)
- Speech intelligibility STIPA (optional)

FFT Analysis + Tolerance

The FFT measurement is the ideal tool for visualization of comb filters and narrow band effects. It allows a detailed frequency response investigation of audio and acoustic systems. The XL2-TA includes an extremely fast, real-time FFT. Optional features are

- High-resolution Zoom-FFT up to 0.4 Hz steps in the frequency range 5 Hz - 20 kHz provided with optional Extended Acoustic Pack or the Spectral Limits Option
- Capture and tolerance function provided with Spectral Limits Option; thus the main menu function reads **FFT + Tol**.

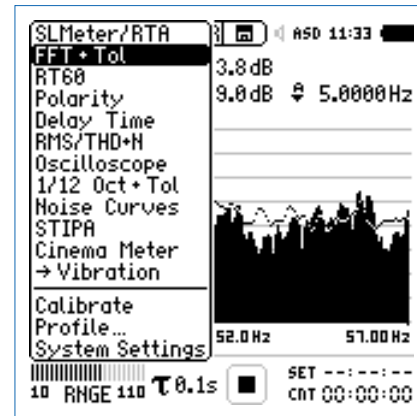

① Result Symbols / Capture & Start Tolerance Mode

This field offers two functions:

- Symbols for measurement results ②

- ② Upper result displayed as line.
- ② Lower result displayed as bargraph.

- Capture & Start Tolerance Mode

The displayed readings may be captured as reference reading C1 to C8 for

- Comparing measurement results against captured traces with relative or absolute curve display.
- Creating tolerance masks based on captured reference curves for passed / failed measurements.

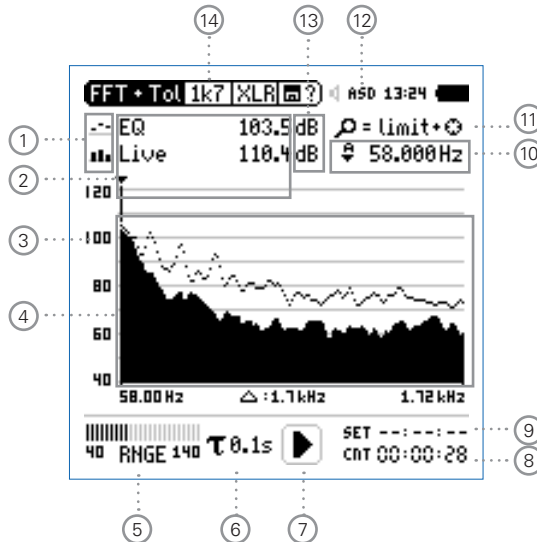

Capture EQ Captures the upper parameter

Capture Live Captures the lower parameter

Manage captures

Allows to rename captures, clear recorded captures, save captures to the SD Card for export from the XL2-TA or load captures from the SD Card for import to the XL2-TA.

Start tolerance mode

Starts the tolerance mode for passed/failed measurements comparing the actual measurement results against a tolerance band.

② Measurement Result

Actual level result of the indicated frequency band. The cursor readout displays the center frequency and the level of the band indicated by the arrow.







Upper parameter displayed as line.



Lower parameter displayed as bargraph.

③ Y-Scale setting

- Select the Y-Axis with the rotary wheel  and confirm with enter .
- Select the zoom factor between **20, 10, 5, 2.5 dB/div** and confirm with enter .
- Scroll up and down with the rotary wheel  to select the Y-axis range.
- Confirm with enter .

④ Measurement Result

Displays the actual and averaged measurement results.

⑤ Input Range

The XL2-TA Analyzer provides three input ranges to accommodate the wide range of input signals. The individual ranges are based on the microphone sensitivity setting in the calibration menu of the XL2-TA. For example at a sensitivity $S=20\text{mV/Pa}$ the input ranges are

- Lower range: 10 - 110 dB SPL
- Middle range: 30 - 130 dB SPL
- Upper range: 50 - 150 dB SPL

Select the lowest possible input range according to the maximum level expected during the measurement; e.g., if the sound pressure will be always below 110 dB SPL, then select the lowest input range 10 - 110 dB SPL.

⑥ Time Weighting

Offers selectable time weighting of **0.1**, **0.2**, **0.5**, **1.0** second as well **FAST** (125 ms) and **SLOW** (1 second). Applications:

Short Time Weighting	High-resolution in time with minimum averaging
----------------------	--

Long Time Weighting	Low resolution in time with longer averaging
---------------------	--

⑦ Run Indication

The run indication shows the measurement status running, paused or stopped. Various measurement settings are locked during ongoing measurements, such as changing the input ranging or the preset measurement time. For passed/failed measurements with the Spectral Limits option the run indication may display **A** for a preset automated level trigger.

⑧ Actual Measurement Time

Counts actual measurement time in hrs:min:sec. Supports setting of time modes: continuous and single.

Timer Mode Continuous

(applicable for standard measurements)
All values are recorded and monitored continuously after starting a measurement with start . The actual measurement time is shown.

Timer Mode Single

Automatically stops the measurement after the pre-set measurement time.

- Set the required measurement time.
- Start the measurement .

⑨ Preset Measurement Time



Adjustment of preset measurement time for single timer setting.

10 Readout Frequency

You may select any frequency to read out individual levels. The selected frequency is indicated by the cursor arrow. Choose between the following settings:



The cursor follows automatically the highest level, e.g. tracing feedback frequencies at live sound.



- Select the frequency with the rotary wheel .
- Press enter .
- You may readout any individual frequency.
- Return to auto frequency with enter .



The cursor returns to the frequency with highest level bar.



The cursor readout may be set manually to any frequency. The readout remains at the selected frequency.







- Select the frequency with the rotary wheel .
- Press enter .
- Select the frequency of interest.
- Confirm with enter .



The cursor readout  displays the measurement results of the selected frequency band.

11 Zoom Mode

(optional, applicable with the Extended Acoustic Pack or the Spectral Limits Option)

- Select the readout frequency  and press enter .
- The zoom mode is displayed above the flashing arrow.
- Select the zoom-in frequency with the rotary wheel .
- Press limit  and zoom the linear frequency scale in or out with the rotary wheel .
- Release limit  and scroll the linear frequency scale left or right with the rotary wheel .

12 Phantom Power Supply

48V

The XL2-TA provides 48 V phantom power supply to the connection microphone or sensor.

ASD

An NTi Audio measurement microphone with automated sensor detection ASD is connected. The XL2-TA reads the electronic data sheet of the microphone and switches the 48V phantom power automatically on

48V

Phantom power is switched off.

13 Measurement Unit

Select the measurement unit as follows:

- dB** Sound level in dB SPL
This measurement unit is permanently selected upon connecting a NTi Audio measurement microphone with electronic data sheet.
- dBu** Input level in dBu
- dBV** Input level in dBV
- V** Input level in Volt



14 Page Selector X-Scale and Parameter Setting

- 20k** Shows FFT result of the frequency band range. 484.38 Hz - 20.453 kHz in a resolution of 140.62 Hz with 143 bins shown on the display.
- 1k7** Shows FFT result of the frequency band range. 58 Hz - 1.722 kHz in a resolution of 11.72 Hz with 143 bins shown on the display.
- 200** Shows FFT result of the frequency band range. 7 Hz - 215.01 Hz in a resolution of 1.46 Hz with 143 bins shown on the display.
- Usr** User Range
(applicable with optional Extended Acoustic Pack or Spectral Limits Option)
5 Hz - 20 kHz in zoom mode with a minimum resolution of 0.366 Hz and 143 bins displayed.
- Set** Selection for FFT Windowing:
- **Hann**: Default for acoustic measurements
 - **Dolph-Chebyshev**: for analyzing small signals (e.g. harmonics) close to a dominant signal.

The page button  switches these display modes.

FFT Analysis - Getting Started

Test Preparations

- Connect the measurement microphone to the XL2-TA.
- Switch on the XL2-TA .
-  The 48V phantom power indication in the upper menu bar changes to ASD. The **XL2-TA** is ready for acoustic measurements.
- Position the XL2-TA at the measurement location using a microphone stand or tripod.

Configuration

The XL2-TA displays two different sound pressure levels at the same time. You configure to display either the levels **Live**, **Max**, **Min**, **EQ** or captured results.

- Select the upper result parameter with the rotary wheel .

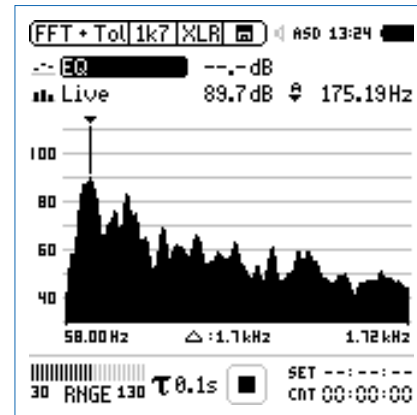

- Confirm with enter .

Select Upper/Lower Reading

👉 The pop-up window **Select reading** appears.

- Select the integrated averaged reading **EQ**. All available selections are Z-weighted (= no weighting).

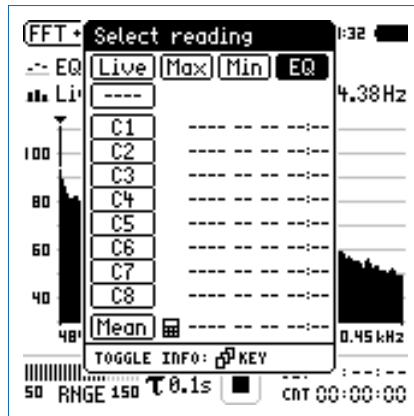

- Confirm with enter ↵.

👉 The pop-up window **Select reading mode** appears.

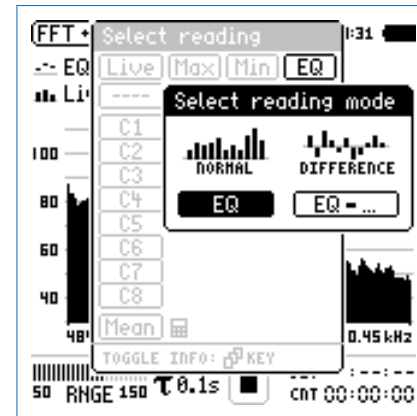

- Select **EQ** for normal absolute display of measurements.
- Follow the same instruction and select the lower FFT reading **Live**.



Press start  to measure and display the sound levels results indicated with ----.

Select Input Range

- Select the lowest possible input range according to the maximum level expected during the measurement.
- Select the input range **RNGE** and press enter
- Turn the rotary wheel to set the applicable input range and confirm with enter .

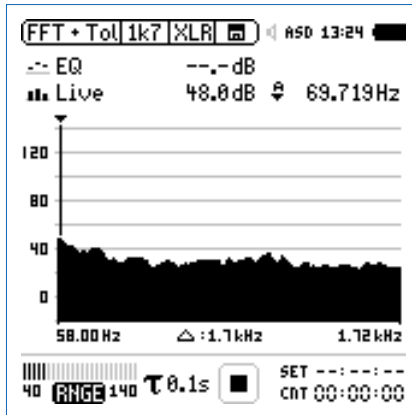

Start Measurement

- The XL2-TA measures the selected sound pressure levels **Live** and **EQ**. All available sound levels are Z-weighted (= no weighting).
- Press start .

The run indication switches to running . The actual sound level Live and the averaged level EQ are displayed. The parameter **RUN** flashes in the memory menu.

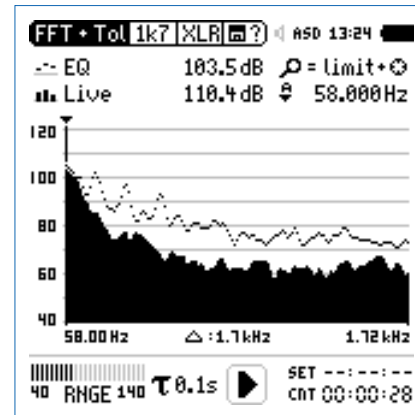

Stop Measurement and Data Saving

- Press stop

The XL2-TA stores the measurement data automatically.

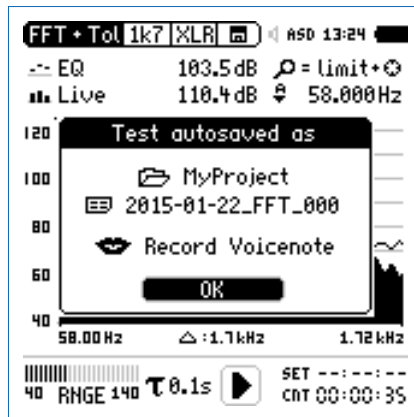

- Press enter to confirm. The measurement data is stored on the SD Card in ASCII format.

The measurement is completed.

Audio Recording

The XL2-TA Analyzer may record a linear audio file (48 kHz, 24 Bit) of the measurement period together with the FFT data. Just load a txt-file named "fftaudio.txt" in the root directory of the XL2-TA. This requires the installed option Extend Acoustic Pack.

Capture References and Create Tolerances

The Spectral Limits Option extends the function range of the XL2-TA with trace capturing, relative curve display and comprehensive tolerance handling for the **FFT** Analysis and the high-resolution **1/12 Oct + Tol** spectral analysis.

Features:

- Captures multiple traces in the internal memory
- Comparing measurement results against captured traces with relative or absolute curve display
- Comprehensive tolerance handling
- Creating tolerance masks based on captured reference curves for passed / failed measurements
- Export and import of tolerance and capture files
- True peak level in 1/1 and 1/3 octave resolution
- High-resolution Zoom-FFT up to 0.4 Hz steps in the frequency range 5 Hz - 20 kHz

Read the detailed description in the separate chapter Capture + Tolerance.

Reverberation Time

The XL2-TA measures the energy decay from 63 Hz to 8 kHz using the Schroeder method in 1/1 octave resolution. The optional Extended Acoustic Pack enables 1/3 octave band resolution from 50 Hz to 10 kHz. Use either an impulse source (e.g., a starter pistol) or an interrupted pink noise as the test signal.

What is Reverberation Time?

Reverberation time is the time required for the sound pressure level to decrease by 60 dB after the sound stimulus signal is stopped. For simple practical measurements the applicable standard ISO 3382 and ASTM E2235 specifies the following two measurement methods:

- T20
 - The measurement requires just a small dynamic measurement range of ~35 dB above the ambient noise level for each frequency band.
 - RT60 (T20) = 3 x decay time of 20 dB
- T30
 - The measurement requires a dynamic measurement range of ~45 dB above the ambient noise level for each frequency band.
 - RT60 (T30) = 2 x decay time of 30 dB

In detail, the reverberation time is based on a linear least-squares regression of the measured decay curve. If the overall reverberation time is short (e.g. < 0.3 seconds) the room acoustic is referred to as being “dead”; for example, a heavily furnished room with thick carpets, curtains and upholstered furniture may have such an acoustic character. If the overall reverberation time is long (e.g. > 2 seconds) the room acoustic is referred to as being “live” and echoic; for example, a large empty room with painted plaster walls and a tiled floor may have such an acoustic character.

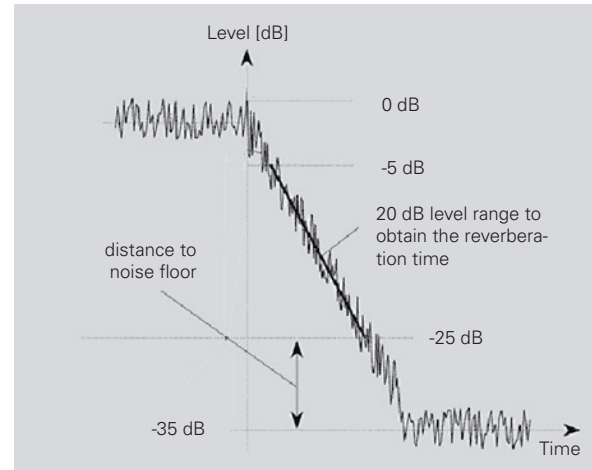

Reverberation Time Measurement with T20 method

RT60 Run Test Page **Run**

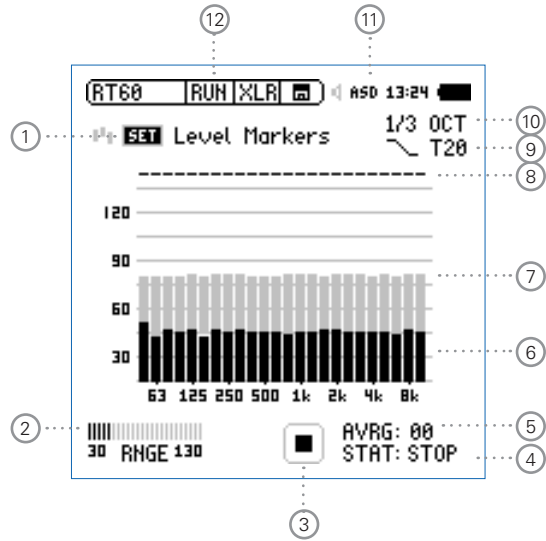

RT60 Result Page **Res**

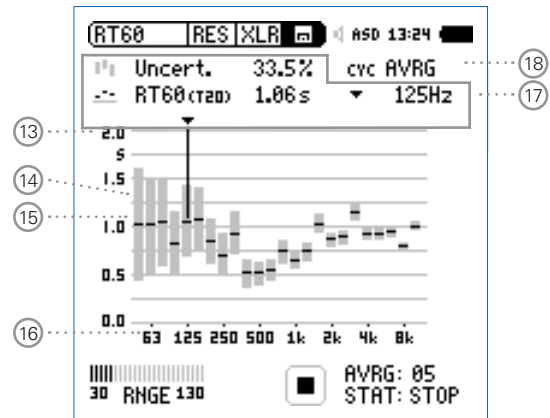

RT60 Cycle Result Page **Res**

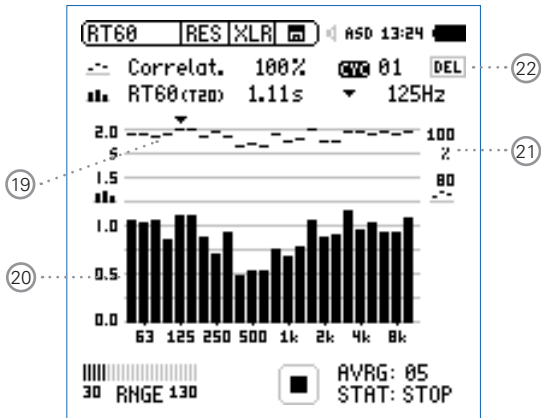

① Set Level Markers

Prior to conducting a reverberation time measurement, the environmental noise is measured, and the required energy level of the test signal is determined.

- Select **SET** and press enter (↵) to measure the actual environmental noise.

👉 The required level markers appear in grey color.

② Input Range

Select between the lower, mid and upper input range. The exact ranges depend on the microphone sensitivity setting in the calibration menu of the XL2-TA.

③ Run Indication

This icon displays the running and stop status of the reverberation time measurement. It is controlled by start/stop (▶■).

④ Measurement Status STAT

Displays the actual measurement status. Start and stop the reverberation time measurement with start/stop . The following status information is displayed:

ARMED Measurement is waiting for the test signal to exceed at least one measurement trigger marker, then the measurement is triggered automatically.

NOISE A sound stimulus signal above the trigger marker is being received.

DECAY Decay is being measured.

PAUSE The measurement has been paused by pressing pause .

STOP No Reverberation time measurement is presently being performed.

⑤ Average AVRG



Counts the measurement cycles. When using an interrupted noise test signal, a minimum of 3 sequential cycles is recommended.

⑥ Actual Real-Time Spectrum

The black bars indicate the actual signal, including background noise. While setting up the reverberation time measurement you should increase the test signal level until the black bars exceed the grey bars completely and the status  displays **NOISE**.

⑦ Level Marker

The grey bars indicate the signal level required for effective reverberation time measurements in each octave band. The marker has a length of 35 dB, and can be set by

- Selecting **SET**  with the rotary wheel .
- Press enter  to measure the environmental noise in the silent room.

⑧ Band Status

Indicates a successful reverberation time measurement above each octave band with a tick .

⑨ Measurement Method

Select between the measurement methods T20 and T30. T20 requires just a small dynamic measurement range of ~35 dB above the ambient noise level for each frequency band. T30 requires a dynamic measurement range of ~45 dB.

⑩ Measurement Resolution

Reverberation time measurement selectable in 1/3 octave or 1/1 octave band resolution. The optional Extended Acoustic Pack enables 1/3 octave band resolution from 50 Hz to 10 kHz.

⑪ Phantom Power Supply

48V The XL2-TA provides 48 V phantom power supply to the connection microphone or sensor.



ASD An NTi Audio measurement microphone with automated sensor detection ASD is connected. The XL2-TA reads the electronic data sheet of the microphone and switches the 48V phantom power automatically on

48V Phantom power is switched off.

⑫ Page Selector

Select between the RT60 run test page and the result page. The page button  toggles between these displays.

 RT60 run test page

 RT60 result page. Toggle with the measurement result selection  among

AVRG RT60 result page showing average of all cycles and uncertainty factor

CYC xx RT60 result page for each cycle

Last RT60 result page for last cycle

⑭ Y-Axis Reverberation Time

Reverberation time in seconds. The scaling is automatically adjusted.

14 Uncertainty Factor

The uncertainty factor is displayed in the RT60 average result page. It indicates the uncertainty of the averaged measurement results, reduces as more cycles are measured, and depends on the measured reverberation time and the bandwidth of the individual frequency band; lower bands show a higher uncertainty factor. The number of measurement cycles is displayed at 5.

15 Overall Reverberation Time Test Result

Readout of reverberation time and uncertainty factor.

 Uncertainty factor. For more details see 14.

 Reverberation time measurement results.

16 X-Axis

Octave Bands 63 Hz - 8 kHz

17 Cursor Readout

Select the individual frequency band and read out the following numeric measurement results

- Uncertainty factor in % or correlation in %.
- Reverberation time RT60 (T20), of the selected frequency band, in seconds (s).

18 Measurement Result Selection

The reverberation time measurement function allows consecutive measurements within one test sequence. An averaged test result of all measurements is automatically calculated.

Select **CYC** and scroll with the rotary wheel through the individual test result cycles showing

Last Last Test Result

Displays the result of last measurement cycle.

xx Single Test Cycle Results

The individual single test results are marked with **CYC xx**, where **xx** is an incriminating number. You may delete individual test results. The averaged reverberation time result uses only the remaining valid measurements. To delete results in a cycle,

- Select **DEL** with the rotary wheel
- Confirm with enter

AVRG Averaged Test Result

The averaged test results of all cycles are calculated and displayed.

19 Correlation Factor in %

The correlation factor is 100% for perfectly linear sound pressure level decay after the sound source has ceased. The natural deviation from this linearity results in lower correlation values. The correlation factor is typically 80 - 100%.

20 Cycle Reverberation Time Test Result

Readout of cycle reverberation time and correlation factor 19 when selection 18 is **CYC xx** or **Last**.

 Correlation Factor. Scale is on the right Y-axis. For more details see 19.

 Reverberation time measurement result of individual displayed cycle. Scale is on the left Y-axis.

21 Y-Axis Correlation Factor

The right Y-axis shows the correlation factor in %. The correlation factor Y-axis is displayed when test result selection 18 is **CYC xx** or **Last**.

22 Delete Cycle Results

Individual cycle results may be deleted, thereby excluding them from the calculation of the **AVRG** result.



Test Signals

Use either an interrupted pink noise or an impulse source as the test signal.

- Interrupted pink noise
Precision measurements require an omni-directional speaker with identical radiation characteristic in all directions. Various interrupted pink noise test signals with different on/off times are offered on the NTi Audio Test CD or USB Flash Drive (included with the XL2-TA) or the Minirator signal generator. Test signals are available for download at <https://my.nti-audio.com/support/XL2-TA>. A minimum of three measurement cycles shall be performed. The XL2-TA averages these readings automatically.
- Impulse
The trigger signal is an impulse source, such as a starter pistol, starter clap or bursting balloon. Individual measurements, or test sequences with repeated trigger signals, can be carried out.

RT60 Measurement - Getting Started

Test Signal: Pink Noise

Play a pink noise signal through an omnidirectional speaker in the room under test. The sound source should be played for a long enough time period to ensure that a balance between injected and absorbed acoustic energy has been reached. For example the sound reflections should be given enough time to reach all reflective surfaces in the room. As a rule of thumb, ensure that the pink noise is played for at least the time period of the estimated reverberation time test result. If in doubt, play the Minirator MR-PRO, the Test Signal CD or or USB Flash Drive as sound source for at least 5 seconds for each cycle. Each time the source signal stops, the XL2-TA recognizes this interruption, triggers, measures the decay time and calculates the reverberation time automatically. A minimum of three measurement cycles shall be performed.

Test Signal: Impulse

Fire an impulse sound source in the room under test, e.g. use a starter pistol, starter clap or bursting balloon. The XL2-TA measures the decay time and calculates the reverberation time automatically.

Test Preparations

The XL2-TA reads the electronic data sheet of any connected ASD microphones provided by NTi Audio and switches the 48V phantom power automatically on as follows:

- Connect the measurement microphone to the XL2-TA.
- Switch on the XL2-TA .

 The 48V phantom power indication in the upper menu bar changes to ASD. The **XL2-TA** is ready for acoustic measurements.

- Position the XL2-TA at the measurement location using a microphone stand or tripod.
- Select the **RT60** function in the measurement menu and toggle with page  to the run page **RUN**.
- Prepare the environment for the measurement. For example mute all sound sources to establish silence.

Set Level Markers

- Select the parameter **SET** with the rotary wheel and press enter .

The environmental noise is measured and the grey level markers are set.

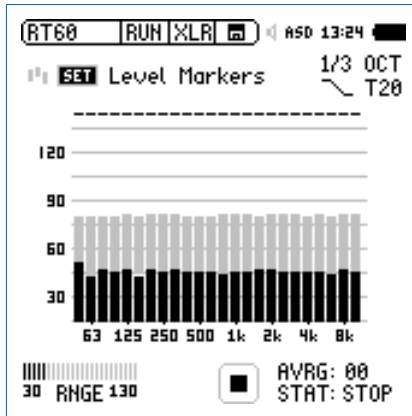

Get Ready for the Reverberation Time Measurement

- Protect the ears against high sound pressure levels, as the test signals might be very loud.

Setting the pink noise level:

- Start the pink noise test signal with the appropriate on/off time according to the room. Use an initial low level.
- Increase the test signal level until all level markers for the minimum test signal level are passed. Use an equalizer to push individual band levels.
- Switch off the interrupted pink noise signal after you have finished setting the pink noise level.

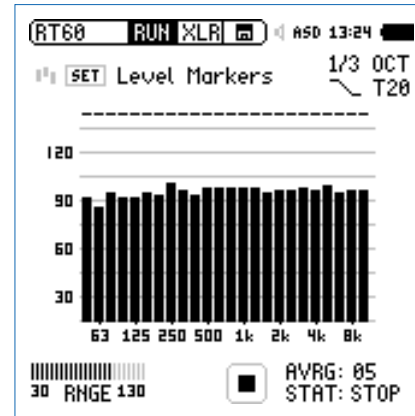

Start the Measurement

- Press start . The status indication switches to **ARMED**.
- Enable the test signal; e.g., switch on the interrupted pink noise signal or fire a starter pistol.
- The black bars have to exceed the grey bars completely.

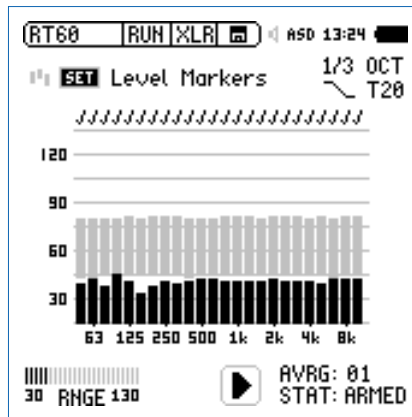

Continue the Measurement

Using pink noise:

The interrupted pink noise test signal continues with the preset on/off time. The XL2-TA automatically triggers at each cycle. Complete a minimum of three test cycles to accurately calculate the uncertainty factor. Perform more cycles to increase the measurement accuracy (= smaller uncertainty factor).

Using an impulse source:

A single impulse at one measurement location is sufficient. No further measurements are required to increase the statistical measurement accuracy.



Confirmation marks ✓ indicating successful measurements, are displayed above each band.

Stop the Measurement and Read Out the Result

- Press stop
- If applicable, switch off the pink noise test signal.
- Select the result page **RES** with page .



The average reverberation time for each frequency band is displayed in seconds and the measurement uncertainty in %.

Read Out the Individual Cycle Result

- If multiple cycles have been recorded, then select **CYC** with the rotary wheel , press enter and select the individual cycle result with the rotary wheel .



Within each cycle, the reverberation time for each frequency band is displayed in seconds and the correlation factor in %.

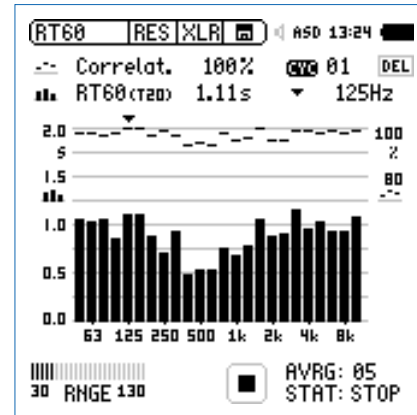
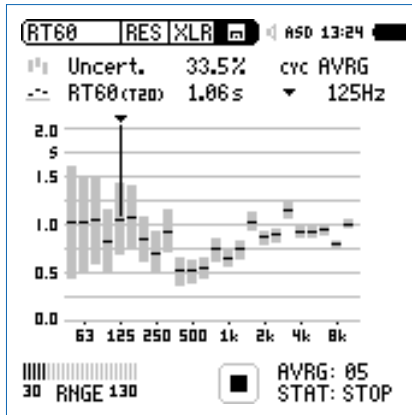

The reverberation time measurement is completed.

Measurements with multiple source and microphone positions

Room resonances may be applicable at individual measurement positions. Thus, perform reverberation time measurements at further positions within the room and average all readings.

Overload Indication

In case the measurement result exceeds the preset measurement range, then limit arrows  indicate this overload condition.

Possible causes for exceeding measurement ranges are

- The measured sound pressure level exceeds the pre-set measurement range -> select the next higher measurement range or reduce the input signal level as applicable.
- The input level is near the maximum level of the connected NTi Audio measurement microphone.

In case the level cannot be reduced (e.g. using a gun as signal source) then the overload condition can be skipped by storing a text-file with the filename "RT60allowOVLDT.txt" on the XL2-TA main directory.

Error Indications

Various error indications are displayed for unsuccessful reverberation time measurements. Corrupt cycles can be deleted individually. These results are then excluded from the average calculations.

• **LOW LEVEL**

This is the abbreviation of "low test signal level" during the measurement. Increase the test signal level until the black level markers exceed the grey level markers in every frequency band. Also, ensure that the level falls below the grey level markers, otherwise use a reverberation time test signal with longer on/off times.

• **T>18S**

The measured reverberation time exceeds the time limit of 18 seconds. This is commonly caused by either an incorrect analyzer range setting or environmental noise. In the first case, choose another range setting. In the second case, ensure that the environmental noise remains constant during the measurement, and/or **SET** the level markers again while the environmental noise is high.

Polarity

Polarity measurement is important in matching the left and right speakers for a good stereo sound image. The polarity function measures the polarity of cables, single speakers and speaker cabinets. For testing, use the polarity signal provided on the Minirator test signal generator, the NTi Audio Test CD or USB Flash Drive.

The polarity of individual speakers or speaker cabinets might change with the frequency. For example, the mid-range speaker polarity may differ from the woofer polarity within the same speaker cabinet. Therefore, the polarity detailed result page of the XL2-TA displays the measured polarity of the individual octave bands from 125 Hz to 8 kHz. This allows in-depth verification of the polarity - frequency relationship.



- Polarity is a simple test within the very complex science of signal phasing. Drivers, speakers and crossovers all cause phase shifts of the audio signal.
- The polarity of various speakers within the same cabinet may differ by design!
- Polarity testing is useful for checking the correct wiring of similar speaker systems.

Positive/Negative Result Page

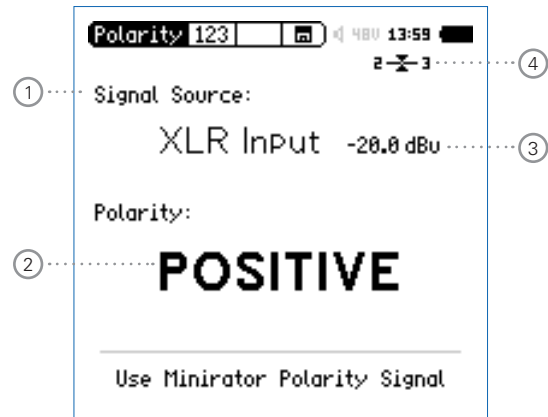

Detailed Result Page

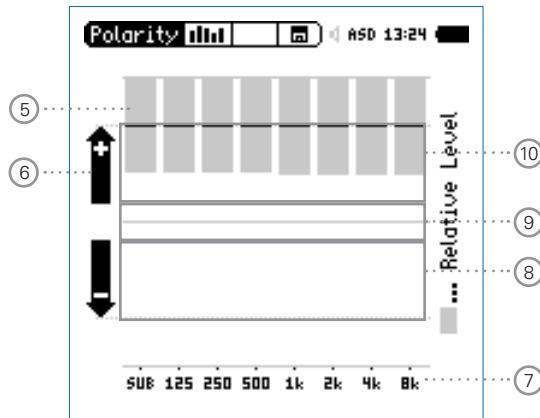

Polarity result for Minirator connected directly to XL2-TA Analyzer

① Input Selection

Select the signal source as follows:

- Select **Signal Source** with the rotary wheel
- Press enter to select either

Voice Note Mic Use the internal voice note microphone of the XL2-TA for polarity measurements. This selection disables the rear speaker.

XLR Input Measure the acoustic polarity with a measurement microphone. Alternatively, measure the polarity of an electrical signal connected with an XLR audio cable.

RCA Input Measure the polarity of an electrical signal connected with an RCA audio cable.

② Polarity Test Result

Displays either **POSITIVE**, **NEGATIVE** or **???** (=undefined). For further visual indication, the limit button illuminates green for **POSITIVE** and red for **NEGATIVE** polarity.

③ Level RMS

Measures the absolute level of the input signal. The unit's dBu, dBV and V are selectable.

④ Balance Indicator

Indication of the audio signal balance between pin 2 and 3 on the XLR input for input signals > -34 dBu.



The input signal is balanced.



The signal is unbalanced. The level of pin 2 is higher than pin 3.



The signal is unbalanced. The level of pin 3 is higher than pin 2.

⑤ Relative Level Indicator

The grey area shows the measured signal energy within the individual frequency bands. The bands with the biggest energy have the most effect on the actual displayed **POSITIVE / NEGATIVE** polarity result.

⑥ Polarity Indication

- + Polarity of frequency band is positive. The polarity result is in the upper display area; the + area.
- Polarity of frequency band is negative. The polarity result is in the lower display area; the - area.

⑦ X-Axis

Seven octave bands with center frequencies from 125 Hz to 8 kHz. **SUB** displays the polarity of Sub-woofers; frequency range < 100 Hz.

⑧ Negative Polarity Area

Measurement results area with negative polarity (-). The black line in the middle of relative level indicator ⑤ displays the measured polarity of the individual frequency band. The dashed line indicates the lower limit of the measurement result area.

⑨ Uncertain Polarity Area ???



Polarity results for frequency bands in this area are uncertain. Therefore, the polarity result ??? is displayed.

⑩ Positive Polarity Area

Measurement results area with positive polarity (+). The black line in the middle of relative level indicator ⑤ displays the measured polarity of the individual frequency band. The dashed line indicates the upper limit of the measurement result area.

Polarity Measurement - Getting Started

For acoustic polarity measurement you can use the internal voice note microphone, or an external measurement microphone, plugged into the XLR input. The polarity result for left and right speaker cabinets should match for a good stereo sound image.

- Feed the speaker cabinet with the polarity test signal of the Minirator.
- Adjust the test level (at Minirator or amplifier) until the test signal is clearly heard.
- Enable the polarity test signal at the left speaker cabinet; mute the right speaker cabinet.
- To activate the internal microphone, select **Signal Source** with the rotary wheel  and choose **Voice Note Mic** with enter .
- Measure the polarity of the left speaker cabinet and save the screenshot in the memory menu .
- Enable the polarity test signal at the right speaker cabinet; mute the left speaker cabinet.
- Measure the polarity of the right speaker cabinet.
- Compare the polarity test result of both speaker cabinets.

 The polarity measurement is completed.

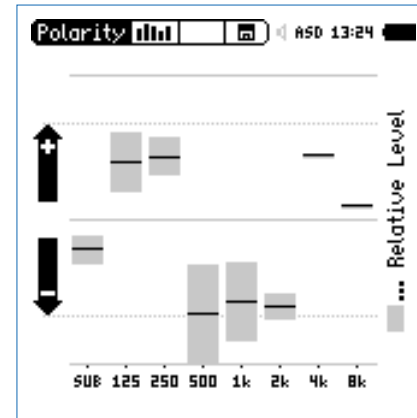

The sample result shows the polarity as:

- Sub-woofer: Low energy, no sub installed
- Woofer: Positive
- Mid-range: Negative
- Tweeter: Positive (with small levels)

The major part of the signal energy is measured in the mid-range frequency bands. Therefore, the overall displayed polarity is **NEGATIVE**.

Delay Time

The delay time measurement function is suitable for accurate configuration of delay line setups, by optimizing the directionality of the signal source. The XL2-TA measures the delay time between the reference signal and the acoustic signal from the speaker. The acoustic delay settings are displayed, allowing you to easily set the measured delay time into the delay device in the rack. The NTi Audio delay time test signal is provided either by the Minirator MR-PRO, MR2 or the NTi Audio Test CD / USB Flash Drive included with the XL2-TA.

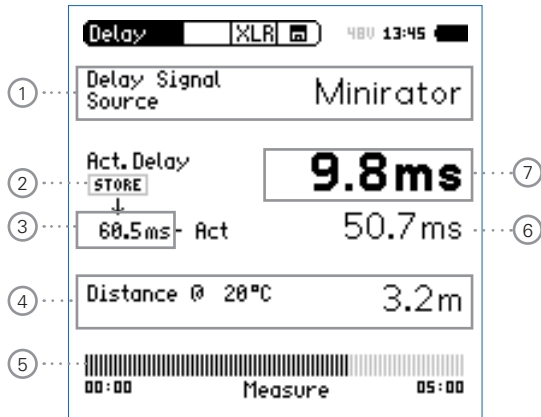

① Delay Signal Source

Select the signal source for the delay measurement:

CD Player Using the NTi Audio Test CD; this setting implies the synchronization time bar is set to 100 seconds = 1 min. 40 sec.; after 100 seconds the XL2-TA has to be synchronized to the delay test signal again.

Minirator The Minirator MR-PRO and MR2 provides a more reliable test signal source than a CD player. Therefore, the XL2-TA offers an extended time range without synchronization. Only after 300 seconds (5 minutes) does the XL2-TA have to be synchronized to the delay test signal again.

② Store Button

Press the store button to record the actual delay **⑦** of the reference speaker.

③ Reference Delay Time

Individually-stored delay time of reference speaker.

④ **Calculated Distance**

Distance from measurement position to speaker in meters or feet, based on the defined temperature in °C or °F

⑤ **Synchronization Time Bar**

The automated synchronization allows delay time measurements without any connected electrical reference signal for 100 seconds using the NTi Audio Test CD / USB Flash Drive or 300 seconds using the Minirator, MR2 or MR-PRO. It displays the time remaining until the next required synchronization.

⑥ **Calculated Delay Time: Store - Actual**

Calculated difference between delay time of speaker A and speaker B as shown on the next page. The automated difference calculation simplifies the verification of delay line arrangements, such as those used in larger halls or auditoriums.

⑦ **Actual Delay**

Actual measured delay time referring to the electrical reference signal.



Delay Test utilizes VoiceNote Microphone

The XL2-TA uses the internal VoiceNote microphone to measure the acoustic delay. Do not connect any measurement microphone to the XL2-TA for the delay time measurement.



Rear Speaker

The rear speaker on the XL2-TA is disabled during delay measurements, thereby avoiding measurement failures. The headphone output is active.

Delay Measurement - Getting Started

The delay time measurement is conducted between the synchronized electrical input signal and the acoustic signal measured by the built-in voice note microphone. In this example, the delay between speakers A and B in the illustrated auditorium is measured.

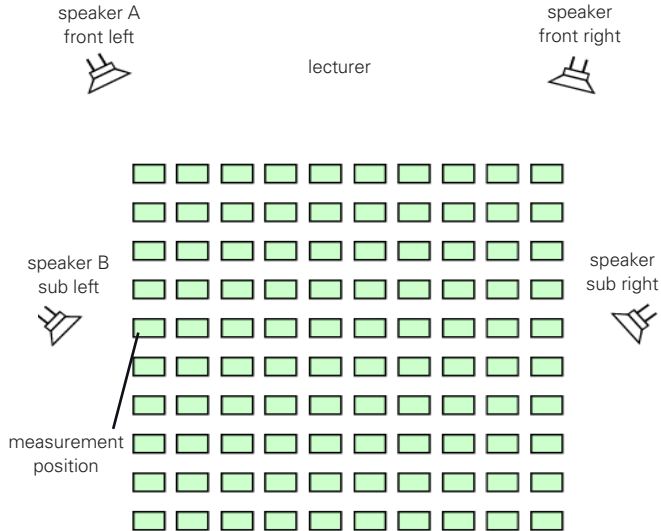

Test Preparations

- Prepare the delay test signal; use either the
 - NTi Audio Test CD or USB Flash Drive
 - NTi Audio Minirator for analog systems
 - NTi Audio Digirator for digital or Dolby/DTS systems
- Start the delay test signal.
- Connect the generated delay test signal with an audio cable to the RCA or XLR input of the XL2-TA, e.g. take the reference signal from an auxiliary channel of a mixing console.
- Select XLR or RCA input in the upper XL2-TA menu
- Set the actual environment temperature, to ensure that the distance is displayed correctly later.

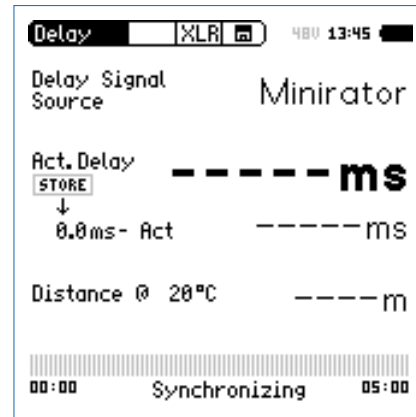

- Wait until the XL2-TA synchronizes to the incoming delay test signal, then the synchronization time bar fills up.

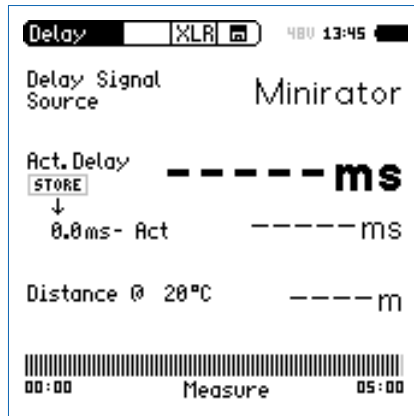

- Disconnect the audio cable, with the synchronizing signal, from the XL2-TA, allowing you to move around freely for the delay measurement. When selecting **Minirator** as the delay signal source, the XL2-TA has to be synchronized to the signal source again after 5 minutes. When selecting **CD Player** as the delay signal source, the XL2-TA has to be synchronized to the signal source every 100 seconds.

Measure Reference Speaker A

- Start the delay test signal at speaker A, mute speaker B.
- Position yourself with the XL2-TA at the measurement position next to speaker B sub left as indicated above. This is the worst-case position in the auditorium with regard to acoustic delay in the sound field. The XL2-TA uses the VoiceNote microphone for the delay test; do not connect any measurement microphone.

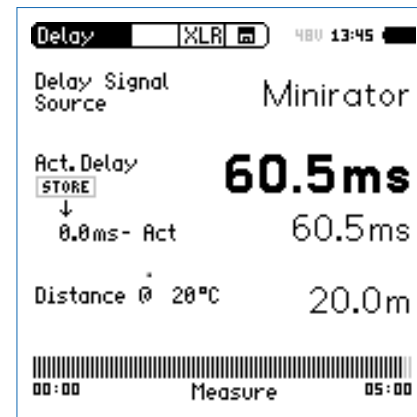

- 👉 The XL2-TA measures the delay time of speaker A in reference to the electrical input signal in milliseconds.

Store Reference

- Select the displayed **0.0 ms** below **Act. Delay** with the rotary wheel and press enter .

The reference result of speaker A is stored for the difference calculation of delay A - B.

- Stop the delay test signal at speaker A.

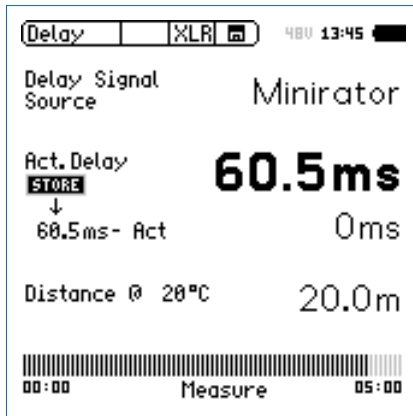

Measure Sub Speaker B

- Start the delay test signal at speaker B. Mute speaker A.
- Position yourself with the XL2-TA at the shown measurement position. The XL2-TA uses the VoiceNote microphone for the delay test; do not connect any measurement microphone.

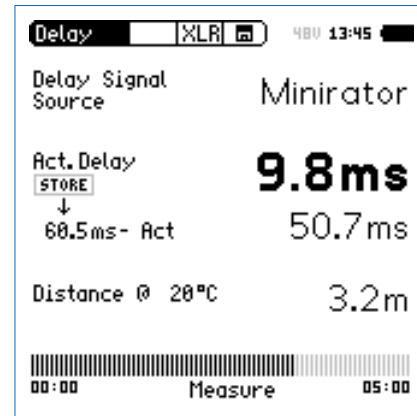



The XL2-TA measures the delay time of speaker B in reference to the electrical input signal in milliseconds.

Automated Difference Calculation

- The delay time difference between speaker A and B is automatically calculated and shown below the **Act. Delay** result.

 The delay time is measured.

	<p>Delay Test utilizes VoiceNote Microphone The XL2-TA uses the internal VoiceNote microphone to measure the acoustic delay. Do not connect any measurement microphone to the XL2-TA for the delay time measurement.</p> <p>Measurement Position Do not position the XL2-TA too close to reflecting surfaces, such as walls or floors. The reflections are likely to prevent accurate measurements.</p>
---	---

	<p>Result Interpretation</p> <ul style="list-style-type: none"> • The resulting time in milliseconds shows the time difference of the sound signal from speaker A and B arriving at the measurement position. Speaker B has to be delayed by the displayed difference result. • To optimize directionality, add a further 5 ms to the calculated difference. The main signal from speaker A then arrives at the measurement position first. The acoustic signal from sub speaker B arrives 5 ms later. This improves the subjective directionality perception of the listeners. <p>Distance in meter/feet The distance results in meter/feet are displayed below for easy verification of the test results accuracy. The readings are based on 330 m/s sound speed at 0°C / 32°F.</p>
---	---

1/12 Octave + Tolerance (optional)

The Spectral Limits Option extends the XL2-TA function range with an RTA analyzer with spectral resolutions from 1/1 octave down to 1/12th octave. Trace capturing, relative curve display and comprehensive tolerance handling are supported in the **FFT Analysis** and the high-resolution **1/12 Oct + Tol** spectral analysis.

Features

- High-resolution RTA function “1/12 Oct + Tol” with selectable 1/1, 1/3, 1/6 and 1/12 octave spectral resolution
- Capturing of multiple readings into the internal memory
- Comparing measurement results against captures with relative or absolute curve display
- Comprehensive tolerance handling with tolerance masks based on captures for passed/failed measurements
- Export and import of tolerance and capture files
- Frequency band listening at rear speaker

Applications

- **PA-rental:** Verifying the frequency response of returned speakers and microphones against reference records ensuring they are back in stock in good working condition.
- **Industrial quality testing:** Passed/Failed test in the production line or during service of any audible quality criteria, such as with motors, machines, vacuum cleaners, ...
- **Cinema:** Comparing frequency responses against an ideal response curve according the X-Curve requirements.

Tolerance Handling

The XL2-TA Analyzer compares spectral measurements against a tolerance band and visualizes exceptions in every frequency band. The passed/failed condition is further visualized by the limit button  and forwarded to the I/O interface of the instrument in order to drive an external alarm device such the accessory SPL Stack Light.

Tolerance curves can either be imported from txt-files or directly derived from captured measurements. The XL2-TA calculates tolerance bands based on

- Single captured results
- Manually generated txt-files on the PC
- Mean average of multiple captures
- Min/Max curves of multiple captures

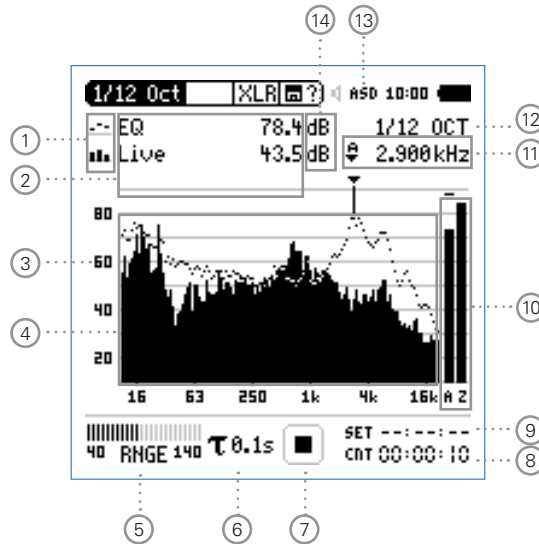

① Result Symbols / Capture & Start Tolerance Mode

This field offers two functions:

- Symbols for measurement results ②

- ② Upper parameter displayed as line.
- ② Lower parameter displayed as bargraph.

- Capture & Start Tolerance Mode

The displayed spectral readings may be captured in C1 - C8 for

- Comparing measurement results against captures with relative or absolute curve display.
- Creating tolerance masks based on captures for passed / failed measurements.

Capture EQ Captures the upper parameter

Capture Live Captures the lower parameter

Manage captures Allows to rename captures, clear recorded captures, save captures to the SD Card for export or load captures from the SD Card for import to the XL2-TA.

Start tolerance mode Starts the tolerance mode for passed/failed measurements comparing the actual measurement results against a tolerance band.





② Measurement Result

Actual level result of the indicated frequency band. The cursor readout displays the center frequency and the level of the band indicated by the arrow.

 Upper parameter displayed as line.

 Lower parameter displayed as bargraph.

③ Y-Scale setting

- Select the Y-Axis with the rotary wheel  and confirm with enter .
- Select the zoom factor between **20, 10, 5, 2.5 dB/div** and confirm with enter .
- Scroll up and down with the rotary wheel  to select the Y-axis range.
- Confirm with enter .

④ Spectral Measurement Result

Spectral results in 1/1, 1/3, 1/6 or 1/12 octave band resolution. Adjust the resolution at .

⑤ Input Range

The XL2-TA Analyzer provides three input ranges to accommodate the wide range of input signals. The individual ranges are based on the microphone sensitivity setting in the calibration menu of the XL2-TA. For example at a sensitivity $S=20\text{mV/Pa}$ the input ranges are

- Lower range: 10 - 110 dB SPL
- Middle range: 30 - 130 dB SPL
- Upper range: 50 - 150 dB SPL

Select the lowest possible input range according to the maximum level expected during the measurement; e.g., if the sound pressure will be always below 110 dB SPL, then select the lowest input range 10 - 110 dB SPL.

⑥ Time Weighting

Offers selectable time weighting of 0.1, 0.2, 0.5, 1.0 second as well FAST (125 ms) and SLOW (1 second). Applications:

Short Time Weighting	High-resolution in time with minimum averaging
Long Time Weighting	Low resolution in time with longer averaging

⑦ Run Indication

The run indication shows the measurement status running, paused or stopped. Various measurement settings are locked during ongoing measurements, such as changing the input ranging or the preset measurement time.

For passed/failed measurements with the Spectral Limits option the run indication may display **A** for a preset automated level trigger.

⑧ Actual Measurement Time

Counts actual measurement time in hrs:min:sec. Supports setting of time modes: continuous and single.

CNT Timer Mode Continuous

(applicable for standard measurements)

All values are recorded and monitored continuously after starting a measurement with start .

The actual measurement time is shown.



Timer Mode Single

Automatically stops the measurement after the pre-set measurement time.

- Set the required measurement time.
- Start the measurement .

⑨ Preset Measurement Time

Adjustment of preset measurement time for single timer setting.

⑩ Broadband Results

User-selectable display of broadband results:

Broadband A A-weighted level

Broadband C C-weighted level

Broadband Z without any frequency weighting

- none

Sum of bands Sum of displayed frequency bands (only available when **#HideUnusedBands** is set to True within the tolerance file)



11 Readout Frequency

You may select any frequency to read out individual levels. The selected frequency is indicated by the cursor arrow.

Choose between the following settings:



The cursor automatically follows the highest level, e.g. tracing live performance feedback frequencies



- Select the frequency with the rotary wheel .
- Press enter .
- You may read out any individual frequency.
- Return to auto frequency with enter .



The cursor returns to the frequency with highest level bar.



The cursor readout may be set manually to any frequency band or wideband level. The readout remains at the selected frequency.





- Select the frequency with the rotary wheel .
- Press enter .
- Select the frequency of interest.
- Confirm with enter .



The cursor readout  displays the measurement results of the selected frequency band.

12 Setting of Test Result Resolution

Set the spectral result display to 1/1, 1/3, 1/6 or 1/12 octave band resolution as follows:

- Turn the rotary wheel  to select the parameter .
- Press enter  to open the selection window.
- Turn the rotary wheel  to select **1/1 OCT**, **1/3 OCT**, **1/6 OCT** or **1/12 OCT**
- Press enter  to confirm.

13 Phantom Power Supply

48V

The XL2-TA provides 48 V phantom power supply to the microphone or sensor.

ASD

An NTi Audio measurement microphone with automated sensor detection ASD is connected. The XL2-TA reads the electronic data sheet of the microphone and switches the 48V phantom power automatically on.

48V

Phantom power is switched off.



14 Measurement Unit

Select the measurement unit as follows:

- dB** Sound level in dBSPL
This measurement unit is permanently selected while an NTi Audio measurement microphone with electronic data sheet is connected.
- dBu** Input level in dBu
- dBV** Input level in dBV
- V** Input level in Volt

Band Listening

The selected frequency band of the input signal is audible on the rear speaker or at the head-phone output.

- Press and hold the speaker button  down. The pop-up window **Volume** is displayed.
- Keep the speaker button  pressed and press enter  at the same time.

 The band listening is activated.

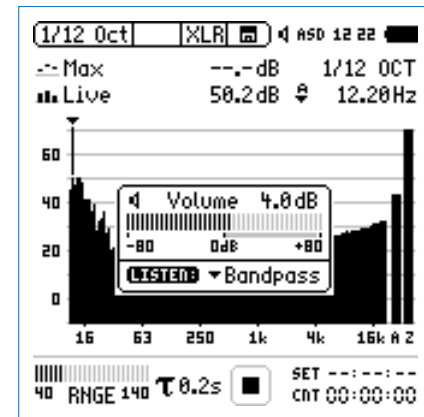

1/12 Octave - Getting Started

Test Preparations

The XL2-TA reads the electronic data sheet of any connected ASD microphones provided by NTi Audio and switches the 48V phantom power on automatically as follows:

- Connect the measurement microphone to the XL2-TA.
- Switch on the XL2-TA

The **48V** phantom power indication in the upper menu bar changes to **ASD**. The XL2-TA is ready for acoustic measurements.

- Position the XL2-TA at the measurement location using a microphone stand or tripod.
- Select the **1/12 Oct + Tol** function in the measurement menu.



The displayed wideband and spectral levels are measured and stored simultaneously.

Configuration

The XL2-TA displays two different sound pressure levels at the same time. You configure to display either the levels **Live**, **Max**, **Min**, **EQ**, **EQ1**, **EQ4** or captured results.

- Select the upper result parameter with the rotary wheel .

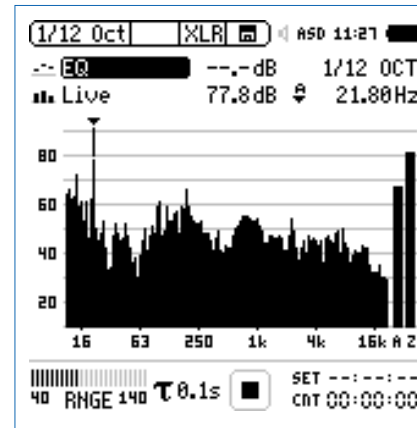

- Confirm with enter .

Select Upper/Lower Reading

👉 The pop-up window **Select reading** appears.

- Select the time-averaged sound level **EQ**. All available selections are Z-weighted (= no weighting).

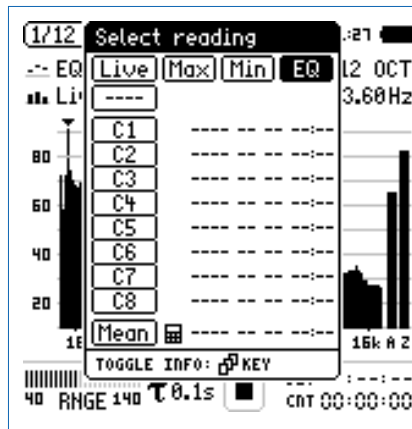

- Confirm with enter

👉 The pop-up window **Select reading mode** appears.

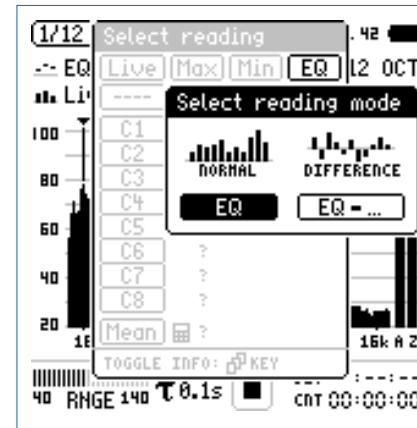

- Select **EQ** for normal absolute display of measurements.
- Follow the same instruction and select the lower spectral reading **Live**.



Press start to measure and display the sound levels results indicated with ----.

Select Input Range

Select the lowest possible input range according to the maximum level expected during the measurement.

- Select the input range **RNGE** and press enter (↵).
- Turn the rotary wheel (⦿) to set the applicable input range and confirm with enter (↵).

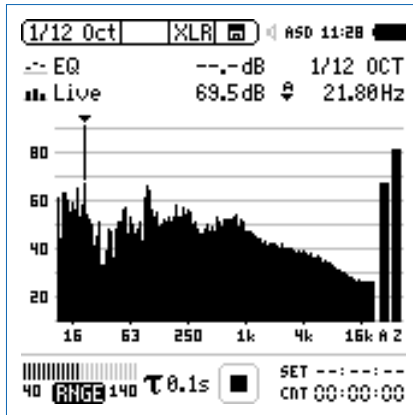

Start Measurement

- The XL2-TA measures the selected sound pressure levels **Live** and **EQ**. All available sound levels are Z-weighted (= no weighting).
- Press start (▶).

👉 The run indication switches to running (▶). The actual sound level Live and the averaged level EQ are displayed. The parameter **RUN** flashes in the memory menu.

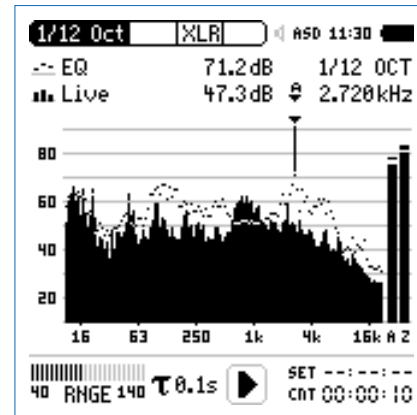

Stop Measurement and Data Saving

- Press stop .

 The XL2-TA stores the measurement data automatically.

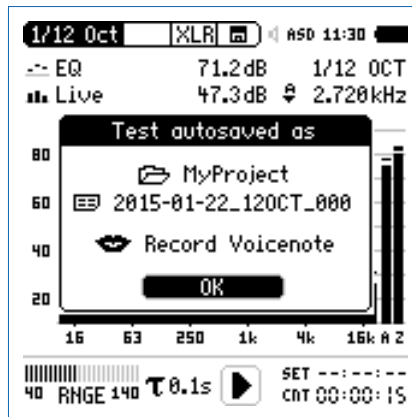

- Press enter  to confirm. The measurement data is stored on the SD Card in ASCII format.

 The measurement is completed.

Audio Recording

The XL2-TA Analyzer may record a linear audio file (48 kHz, 24 Bit) of the measurement period together with the spectral data. Just load a txt-file named "12audio.txt" in the root directory of the XL2-TA. This requires the installed option Extend Acoustic Pack.

Capture References and Create Tolerances

The Spectral Limits Option extends the function range of the XL2-TA with trace capturing, relative curve display and comprehensive tolerance handling for the **FFT** Analysis and the high-resolution **1/12 Oct + Tol** spectral analysis.

Features:

- Capturing of multiple readings into the internal memory
- Comparing measurement results against captures with relative or absolute curve display
- Comprehensive tolerance handling
- Creating tolerance masks based on captures for passed / failed measurements
- Export and import of tolerance and capture files
- True peak level in 1/1 and 1/3 octave resolution
- High-resolution Zoom-FFT up to 0.4 Hz steps in the frequency range 5 Hz - 20 kHz

Read the detailed description in the separate chapter Spectral Limits Option (Capture + Tolerances).

1/12 Octave - Fast Frequency Response Measurement

The XL2-TA provides fast and accurate frequency response measurement within one second using pink noise. For this purpose, the Minirator MR-PRO generates the test signal "Fast Pink Noise" tailored to this application.

Test Signal

The test signal "Fast Pink Noise" is not "random"; it contains an absolutely flat spectrum within the cycle time. The frequency resolution of the test signal is limited to 1 / cycle time; therefore you can choose between two different test signals:

Minirator MR-PRO Test Signal	XL2-TA Frequency Resolution	XL2-TA Measurement Duration
File -> Signals -> Fastpnk1	1/1 Octave 1/3 Octave	1 second
File -> Signals -> Fastpnk4	1/6 Octave 1/12 Octave	4 seconds

Measurement in 1/3 Octave Resolution

- Select the test signal **Fastpnk1** on the Minirator MR-PRO.
- Connect the MR-PRO to the input of the device under test.
- Take the XL2-TA and select the function **1/12Oct**.
- Select the one-third octave band frequency resolution.
- Select the measurement parameter **EQ**, the mode "Single" and set the measurement duration to one second.
- For higher frequency resolutions use the test signal **Fastpnk4** and a measurement duration of four seconds.
- Start the measurement

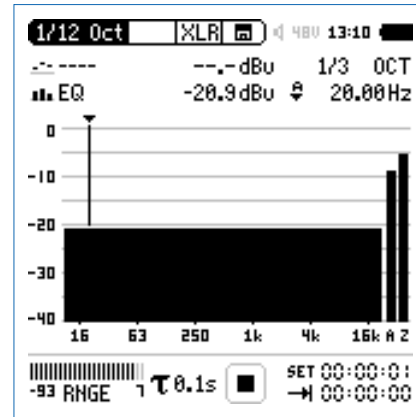

You have successfully completed the measurement.

Optimize the Frequency Response

The fast frequency response measurement with the test signal “Fast Pink Noise” saves time in optimizing the frequency response of audio devices or speakers. During your settings on the equalizer, you will receive a precise result on the XL2-TA screen within one second.

- Select the test signal **Fastpink1** on the Minirator MR-PRO.
- Connect the MR-PRO to the input of the device under test.
- Take the XL2-TA and select the function **1/12Oct**.
- Select the measurement parameter **EQ1**, the mode “Single” and set the measurement duration to one second.
- Adjust the settings on the equalizer.

👍 The XL2-TA displays the actual frequency response within a second.



Test Signal „Fast Pink Noise“ Advantage

Frequency response measurements often use the standard Pink Noise in combination with a 1/n octave analysis. Because of the randomness, longer averaging times are necessary to get accurate results. Too short averaging times result in “noise” in the result, as shown here:

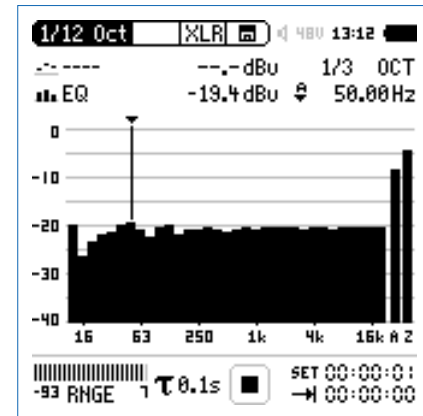

In comparison, the test signal “Fast Pink Noise” enables a precise measurement result within one or four seconds.

Noise Curves (optional)

The Spectral Limits Option extends the XL2-TA with the Noise Curves measurement function. A noise curve may be used to characterize room noise or other environments. Various standardized international noise curves are the most widely used means for evaluating background sound in buildings, and other facilities such as transit facilities, as well as in other indoor/outdoor spaces. Residual noise in buildings may be generated from both environmental sources (e.g. outside traffic) and systemic sources (e.g. heating, ventilating, and air-conditioning (HVAC) systems; or other machinery in use). It is also frequently necessary to measure residual noise curves prior to expected changes in advance of construction or prior to other expected environmental noise changes.

Noise Rating NR

(in accordance with ISO/R 1996-1971)

Noise rating (NR) is a graphical method for assigning a single number rating to a noise spectrum. It can be used to specify the maximum acceptable level in each octave band of a frequency spectrum, or to assess the acceptability of a noise spectrum for a particular application. The method was originally proposed for use in assessing environmental noise, but it is

now used frequently for describing noise from mechanical ventilation systems in buildings. To make a rating, the measured noise spectrum is superimposed on a family of NR contours; the NR of the spectrum corresponds to the value of the first NR contour that is entirely above the spectrum.

Noise Criteria NC

(in accordance with ANSI S12.2-2019 and -1995)

The NC rating of a spectrum is designated as the value of the lowest NC curve above the measured octave-band spectrum. The designating number for any NC curve is, approximately, its Speech Interference Level (SIL): the average of the levels in the 500, 1000, 2000 and 4000 Hz octave bands. SIL is a simple metric, which measures the effects of noise on speech intelligibility. The XL2-TA Analyzer includes the tangency method adaptation in accordance with the standard.

Room Noise Criteria RNC

(in accordance with ANSI S12.2-2019)

The RNC method is used to determine noise ratings when the noise from HVAC systems at low frequencies is high, and which is also suspected of containing sizeable fluctuations or

surging. It essentially represents a rumble criterion. The RNC curves also provide a procedure that reduces the result essentially back to the NC curves when systems are well designed and acoustically well-behaved. Following the RNC specification, the XL2-TA measures the octave-band sound pressure level every 100 ms, followed by processing to determine the applicable room noise criterion (RNC) curve. The minimum measurement time is 20 seconds.

Preferred Noise Criteria PNC

(in accordance with ASA 1971)

PNC curves represent a more stringent method based on an extension of the basic Noise Criteria system. They have been used in the past to judge the acceptability of ventilation and other background broadband noise. PNC curves are less often used than Noise Criteria curves because they are more stringent at lower frequencies than the Noise Criteria curves, but also because the latest (2019) version of Noise Criteria curves also includes an extended frequency range somewhat mitigating the original reasons for PNC.

Room Criteria RC

(in accordance with ANSI S12.2-1995)

The RC criterion curves are a system for use in the design of heating, ventilating, and air-conditioning (HVAC) systems in office buildings, dwelling units, etc., where the desired mid-frequency levels are in the range of 25 to 50 dB. Each RC criterion curve bears a rating number equal to the level at 1000 Hz.

Spectrum classification

- Neutral spectrum (N): The levels at 500 Hz and below do not exceed the RC curve corresponding to a sound level spectrum by more than 5 dB; and the spectrum levels in Band 1000 Hz and higher do not exceed the corresponding RC curve by more than 3 dB.
- Rumble (R): Excessive noise in low-frequency band
The level in one or more of the octave bands at and below 500 Hz exceeds the RC curve corresponding to a spectrum by more than 5 dB.
- Hiss (H): Excessive noise in high-frequency bands
The level in one or more of the octave bands at and above 1000 Hz exceeds the RC curve corresponding to a spectrum by more than 3 dB.
- Vibration and rattle (RV): The level in one or more of the octave bands from 16 Hz through 63 Hz exceeds the criterion for moderately noticeable rattle.

Noise Curves Result Page

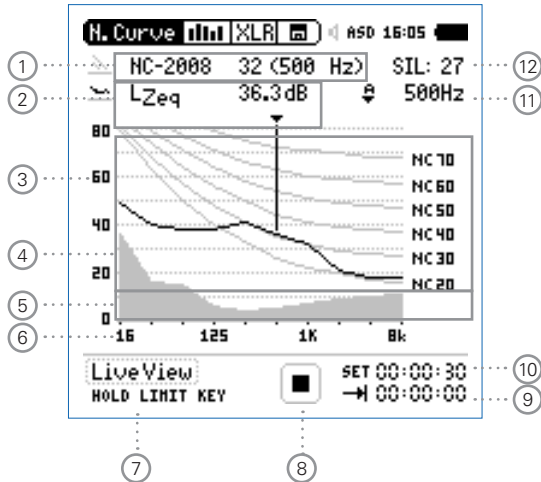

The standards list the noise criteria in 5 dB steps. The XL2-TA measures the noise criteria in detailed 1 dB steps, which are calculated by linear interpolation between the standardized 5 dB levels.

RNC Information Page

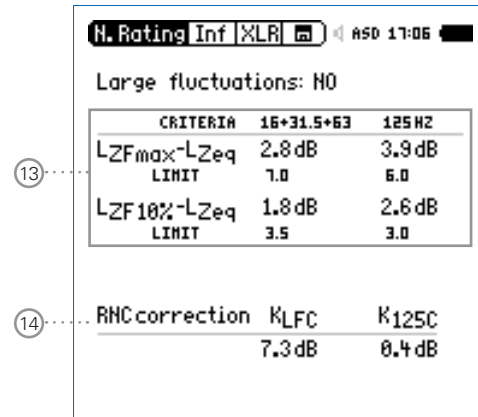

The RNC information page is available when viewing Noise Criteria and Room Noise Criteria results, in accordance with ANSI S12.2-2019. It reports any large fluctuations or surging at low frequencies, e.g. caused by fans.

① Noise Curve

Selection of the noise curve type and measurement result.

Noise Curve Types

- Noise Rating NR
- Noise Criteria NC (2019) and (1995)
- Room Noise Criteria RNC
- Room Criteria RC (1995)
- Preferred Noise Criteria PNC (1971)



Measurement Result

The noise rating of a spectrum is designated as the value of the highest curve "touched" by the measured octave-band spectrum. The octave band in which this "touching" occurs is noted along with the curve designation.

② Measurement Result

Actual level result of the indicated frequency band. The cursor readout displays the center frequency and the level of the band pointed to by the arrow. With the cursor in automatic mode, the arrow points to the frequency band with the highest noise rating as shown in ①.

③ Y-Scale setting

- Auto-Scroll
- Zoom:
 - Select the Y-Axis with the rotary wheel  and confirm with enter .
 - Select the zoom factor between **10, 5, 2.5 dB/div** and confirm with enter .

④ Noise Measurement Result

Real-time spectrum in 1/1 octave band resolution.



⑤ Noise Floor

The grey area shows the noise floor of the connected NTi Audio measurement microphone (provided by the electronic data sheet) in combination with the XL2-TA Analyzer.

⑥ X-Scale

X-Scale from 16 Hz to 8 kHz.

7 Live View

Select the **LiveView** with the rotary wheel  to get an overview of the current noise level. Alternatively press the limit button .

The XL2-TA measures the noise curve after pressing the start button . This will provide the noise rating measurement in accordance with all standards.

8 Run Indication

The run indication shows the measurement status running, paused or stopped. Various measurement settings are locked during ongoing measurements, such as the preset measurement time.

9 Actual Measurement Time

Counts actual measurement time in hrs:min:sec. Supports time modes: continuous and single.

Timer Mode Continuous

(applicable for standard measurements)

All values are recorded and monitored continuously after starting a measurement with start . The actual measurement time is shown.

Timer Mode Single

Automatically stops the measurement after the pre-set measurement time.

- Set the required measurement time.
- Start the measurement .

 The actual measurement time counts back to zero and the measurement ends.

10 Preset Measurement Time

Adjustment of preset measurement time for the timer mode single.



11 Readout Frequency

You may select any frequency to read out individual levels. The selected frequency is indicated by the cursor arrow.

Choose between the following settings:



The cursor follows automatically the frequency band with the highest noise rating.



- Select the frequency with the rotary wheel .
- Press enter .
- You may read out any individual frequency.
- Return to auto frequency with enter .



The cursor returns to the frequency with highest noise rating.



The cursor readout may be set manually to any frequency band or wide band level. The readout remains at the selected frequency.

- Select the frequency with the rotary wheel .
- Press enter .
- Select the frequency of interest.
- Confirm with enter .



The cursor readout  displays the measurement results of the selected frequency band.

12 SIL Measurement Result

The speech interference level (SIL) result is shown for noise curve types NC-2019 and NC-1995 . It is calculated by averaging the octave-band sound pressure levels at 500 Hz, 1000 Hz, 2000 Hz and 4000 Hz. If the measured spectrum in any octave band does not exceed any of the octave bands of that NC(SIL) curve, the spectrum is designated NC(SIL). If one or more octave-band levels exceed the NC(SIL) curve, then the NC curve number may differ to the SIL value, as the NC rating for that spectrum must be determined using the tangency method.

13 Large Fluctuations

This reports any large fluctuations at low frequencies for the Room Noise Criteria RNC in accordance with ANSI S12.2-2019. If one or more displayed measurement results exceed the limits, then large fluctuations exist. Concluding the LEQ levels in the octave frequency bands below 300 Hz are automatically “penalized” at the RNC measurement.

14 Correction Values

The noise curve type RNC uses these correction values based on the measured fluctuation results to determine the RNC curve result.

Recommendations

Type of Room - Space Type	NC and RNC Curve	Level LAeq	RC curve
Concert and recital halls	-	15-18	-
Small auditoriums (≤500 seats)	35-39	25-30	-
Large auditoriums (>500 seats)	30-35	20-25	-
TV and broadcast studios	16-35	15-25	-
Live performance theaters	25-30	20-25	-
Premier movie theaters	25-30	20-25	-
Normal theater	30	25	-
Private residences			
Bedrooms	35-39	25-30	25-30(N)
Apartments	39-48	30-40	30-35 (N)

Type of Room - Space Type	NC and RNC Curve	Level LAeq	RC curve
Family rooms and living rooms	39-48	30-40	30-35 (N)
Hotels/Motels			
Individual rooms or suites	39-44	30-35	25-35 (N)
Meeting/banquet rooms	35-44	25-35	25-35 (N)
Service support areas	48-57	40-50	35-45 (N)
Office buildings			
Offices executive	35-44	25-35	25-35 (N)
Offices small	44-48	35-40	25-35 (N)
Offices large	39-44	30-35	-
Conference rooms large	35-39	25-30	25-35 (N)
Conference rooms small	39-44	30-35	25-35 (N)

Noise Curves - Getting Started

Test Preparations

The XL2-TA reads the electronic data sheet of any connected ASD microphones provided by NTi Audio and switches the 48V phantom power automatically on as follows:

- Connect the measurement microphone to the XL2-TA.
- Switch on the XL2-TA .

 The **48V** phantom power indication in the upper menu bar changes to **ASD**. The XL2-TA is ready for acoustic measurements.

- Select the **Noise Curves** function in the measurement menu.



The microphone should be moved slowly to positions around the entire space at locations that are near the average normal standing or seated height of human ears. The recommended measurement period is more than 20 seconds long.

Configuration

- Select the noise curve type with the rotary wheel .

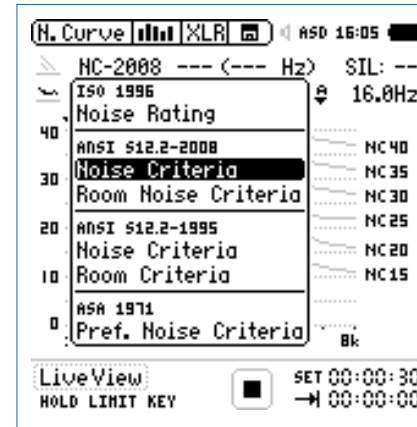

- Confirm with enter .



The XL2-TA measures all noise curve types at the same time, thus you can change the selection also after the measurement.

Start Measurement

- Press start

👉 The run indication switches to running . The actual noise level **LZeq** of the selected octave band is displayed. The parameter **RUN** flashes in the memory menu. The Y-axis adjusts automatically according to the measurement result.

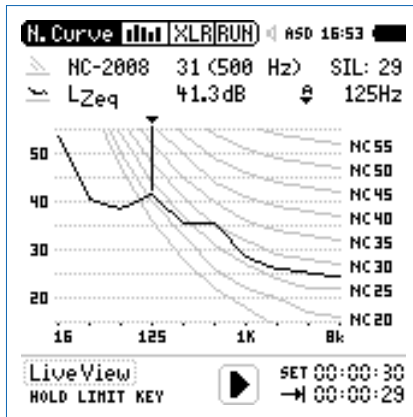

Stop Measurement and Data Saving

- Press stop

👉 The XL2-TA stores the measurement data automatically.



- Press enter to confirm. The measurement data is stored on the SD Card in ASCII format.

👉 The measurement is completed.

Speech Intelligibility STIPA (optional)

The STIPA analyzer option allows reliable measurement of the speech transmission index (STI) within 15 seconds. Besides the single value STI or CIS (= common intelligibility scale) test result, a detailed view of the modulation indices and individual band level results is provided. The STIPA analyzer meets the standard IEC 60268-16, edition 5 released in 2020. The XL2-TA also supports noise corrections, automated averaging of measurements and the older standard editions 2, 3 and 4.

The intelligibility of speech depends on:

- Signal-to-noise ratio
- Psychoacoustic masking effects
- Sound pressure level
- Ambient noise level
- Reverberation time
- Reflections
- Frequency response
- Distortion

The speech intelligibility measurement function STIPA is an option for the XL2-TA Audio and Acoustic Analyzer. Ask your local representative for purchasing details.

Signal Source

Choose the applicable STIPA test signal source:

- | | |
|--------------------|--|
| NTi Audio TalkBox | <p>The NTi Audio TalkBox simulates a person talking at a precise acoustic level, enabling the measurement of the complete signal chain including the microphone.</p> <ul style="list-style-type: none"> • Place the NTi Audio TalkBox in front of the microphone at the typical position of the talking persons head. • Select Track 1 for the STIPA test signal. • Select Output Mode to Speaker; you should hear the STIPA test signal. |
| Minirator MR-PRO | <p>The Minirator MR-PRO is used for electrical signal injection into public address systems that commonly use alarm messages from a hard drive (systems without a microphone).</p> |
| Other Audio Player | <p>Register the XL2-TA and download the STIPA test signal at https://my.nti-audio.com/support/XL2. The maximum tolerable deviation in test signal playback sample frequency is 0.1%.</p> |

The standard STIPA signal is based on random noise limited to the bands contained in a male speech spectrum.

STIPA Numeric Result Page

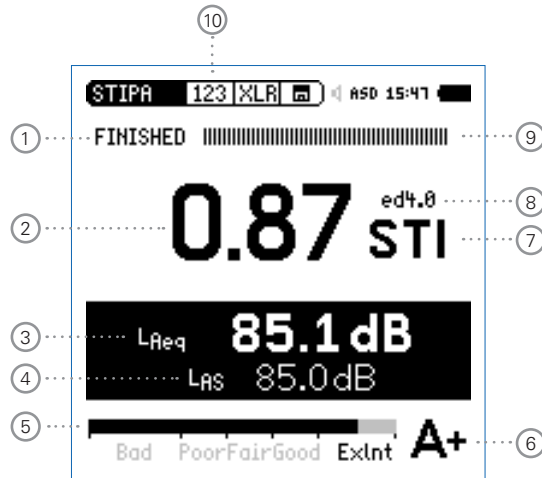

STIPA Table Result Page

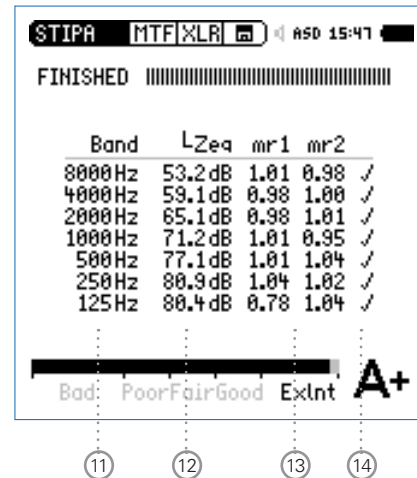

Use only the original NTi Audio test signal for speech intelligibility measurements with the XL2-TA. Other signals may not seamlessly loop, thus causing wrong measurement results!

STIPA Averaging



STIPA Ambient Noise Correction

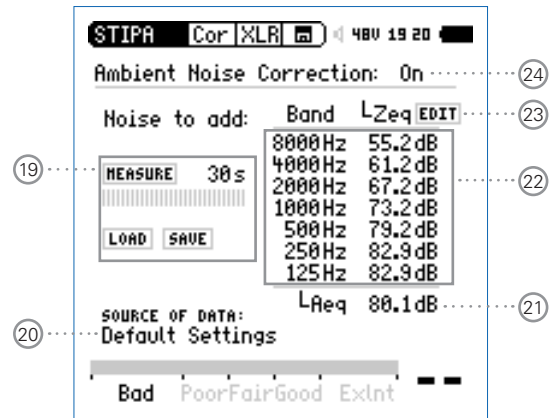

① Run Indication

This icon displays the run status of the measurement.

② Measurement Result

- Single value speech transmission index result.
- Repeatability of measurement result:
Since a dedicated noise test signal is used, the result may deviate by a of maximum 0.03 STI (=Max-Min) at the same measurement position.

③ Sound Level L_{Aeq}

Shows the time-averaged sound level of the 15 seconds measurement cycle time.

④ Sound Level L_{AS}

Actual sound pressure level.

⑤ Analog Test Result Bargraph

Bargraph display and interpretation of the speech intelligibility measurement result

- ExInt 0.75 - 1.00 STI
- Good 0.60 - 0.75 STI
- Fair 0.45 - 0.60 STI
- Poor 0.30 - 0.45 STI
- Bad 0.00 - 0.30 STI

⑥ Qualification Scale

The STI value is shown as a letter representing the qualification scale below. Listed are also examples of typical application environments.

Band	STI Range	Examples of typical uses
A+	> 0.76	recording studios
A	0.72 - 0.76	theatres, speech auditoria, parliaments, courts
B	0.68 - 0.72	theatres, speech auditoria, parliaments, courts
C	0.64 - 0.68	teleconference, theatres
D	0.60 - 0.64	class rooms, concert halls
E	0.56 - 0.60	concert halls, modern churches
F	0.52 - 0.56	PA in shopping malls, public offices, cathedrals
G	0.48 - 0.52	PA in shopping malls, public offices
H	0.44 - 0.48	PA in difficult acoustic environments
I	0.40 - 0.44	PA in very difficult spaces
J	0.36 - 0.40	not suitable for PA systems
U	< 0.36	not suitable for PA systems

7 Measurement Unit

The speech intelligibility result is displayed in STI (Speech Transmission Index) or CIS (Common Intelligibility Scale), whereby CIS is calculated as $CIS = 1 + \log STI$.

8 Edition of Standard IEC60268-16

- ed5.0 actual edition released in 2020 with continuous level dependent auditory masking function
- ed4.0 old edition released in 2011 with continuous level dependent auditory masking function
- ed3.0 old edition released in 2003 with stepped level dependent auditory masking function
- ed2.0 old edition released in 1998 with fixed masking function

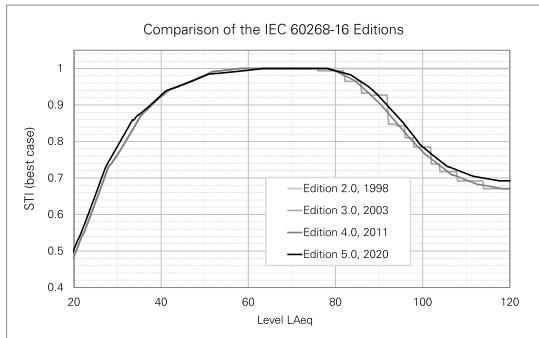

9 Progress Bar

Measurement status indication; a single speech intelligibility measurement takes 15 seconds. The actual measurement time and measurement status are indicated here.

10 Page Selector

Select between these pages:

123 Speech intelligibility measurement result

MTF Table result page with modulation ratio and sound levels for each octave band

Avr On-site averaging of results.

Cor Ambient Noise Correction

The page button toggles between the **123 - Tab - Avr** screens. These pages show the speech intelligibility measurement results. The page **Cor** offers setting the noise spectra prior the STI measurement.

11 Octave Bands

Frequencies 125 Hz - 8 kHz in 1/1 octave band resolution.

12 Sound Pressure Level L_{eq}

Individual time-averaged octave band level L_{eq} .

13 STIPA Modulation Ratio mr1, mr2

For good speech intelligibility it is mandatory that the integrity of the transmitted voice signal modulations are preserved. Therefore, STIPA is based on measuring the MTF (Modulation Transfer Function). This function quantifies the degree to which the voice modulations are preserved in individual octave bands. The STIPA method determines the MTF by analyzing the seven frequency bands. Each band is modulated with two frequencies, resulting in the modulation ratio mr1 and mr2. All indexes together combined with psycho-acoustic models provide the single-value speech intelligibility result.

Band	mr1	mr2
125 Hz	1.60 Hz	8.00 Hz
250 Hz	1.00 Hz	5.00 Hz
500 Hz	0.63 Hz	3.15 Hz
1 kHz	2.00 Hz	10.00 Hz
2 kHz	1.25 Hz	6.30 Hz
4 kHz	0.80 Hz	4.00 Hz
8 kHz	2.50 Hz	12.50 Hz

14 Error Detection

The built in error detection helps identifying faulty measurements caused by the amount of impulsive ambient noise. Such noise influences the accuracy of any speech intelligibility measurement. The error detection checks the following:

- Invalid modulation indices in individual octave bands (mr1 or mr2 > 1.3)
- Changes in ambient noise or any impulsive noise during the measurement (by comparing the first half of the measurement period with the second half)

15 Cycle Reading

The standard IEC 60268-16 recommends measuring the speech intelligibility two or three times at each measurement position. This reduces potential measurement errors. The individual cycle readings are listed here.

16 STI-Average

Calculated average of the recorded cycle results.

17 Difference

Difference (Max – Min) of the of the recorded cycle results.

18 Start next Cycle Measurement

Start the next cycle measurement at the same measurement position here.

19 Ambient Noise Measure / Load / Save

Measure here the actual ambient noise during an adjustable measurement time. You may save this record and reload the data set for any later speech intelligibility measurement.

20 Source of Data

Informs about the source of the ambient noise data. The choices are:

- **Default Settings**
- **Edited manually**
- **Measured** Date Time

This information is documented in the measurement report.

21 LAeq of Ambient Noise

This LAeq is calculated based on the octave band levels; you may manually set this level in accordance with the typical noise level as specified for your application. The default level is 80 dB.

22 Spectral Level of Ambient Noise

Adjustable octave band level from 125 Hz to 8 kHz. The default spectrum is equals the replayed STIPA test signal at LAeq = 80 dB.

23 Activation of manual Octave Band Level Setting

Select **EDIT** with the rotary wheel  to adjust the individual octave band levels.

24 Activation of Ambient Noise Correction

- On** Ambient noise correction is active
- Off** Ambient noise correction is deactivated



The XL2-TA Analyzer has been manufactured in compliance with all specifications as described in IEC 60268-16. Due diligence has been observed in validating

- the measuring system
- the accuracy of the measured STI across a range of relevant reference conditions
- the accuracy of the modulation transfer function matrix.

Question Mark ? at individual Octave Bands

Individual octave bands are marked with ? in case of a

- Missing test signal level
- Invalid modulation indices ($mr1$ or $mr2 > 1.3$)
- Changes in ambient noise or any impulsive noise during the measurement

Flashing Question Marks ?..?? at ②

The measurement result flashes in combination with the question marks ?..?? in case of a

- Question Mark ? at one or multiple octave bands. See the STIPA Table Result Page on the XL2-TA for details.
- Changes in ambient noise or any impulsive noise during the measurement



In case the question marks ?..?? are flashing, then the measurement is faulty. Verify possible causes and repeat the measurement.

For details see the chapter STI Measurement Hints.

STI Measurement - Getting Started

Test Preparations

The XL2-TA reads the electronic data sheet of the connected NTi Audio measurement microphone and switches the 48V phantom power automatically on as follows:

- Connect the measurement microphone to the XL2-TA.
- Switch on the XL2-TA .

 The 48V phantom power indication in the upper menu bar changes to ASD. The XL2-TA is ready for acoustic measurements.

- Position the XL2-TA at the measurement location using a microphone stand or tripod.
- Select the **STIPA** measurement function in the measurement menu.
- Prepare the environment for the measurement. For example mute all sound sources to establish silence.



No impulsive noise shall occur during the speech intelligibility measurement as well no speaking or other noise sources should be allowed near the measurement microphone.

Start STIPA Test Signal

Select the STIPA signal source according your application requirements.

- Switch on the STIPA test signal at the signal source.
- Set the acoustic sound pressure level of the PA system to simulate the typical announcement level; e.g. $L_{AS} = 85$ dB.

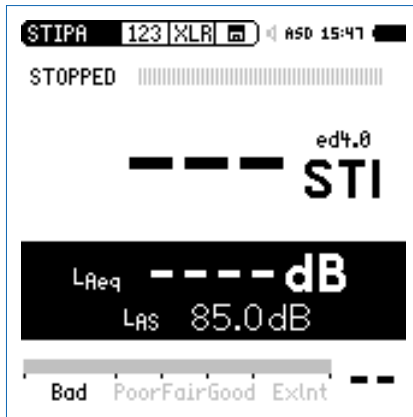

Start Measurement

- Press start

👉 The progress bar switches to **RUNNING**. The test result tendency is shown on the bargraph, marked with **Bad**, **Poor**, **Fair**, **Good** and **ExInt**.



Stop Measurement and Data Saving

After the period of 15 seconds the speech intelligibility measurement finishes automatically. The progress bar indications switches to **FINISHED** and the final test result is displayed. The measurement result is stored automatically.

- Switch off the STIPA test signal.



- Press enter  to confirm. The measurement data is stored on the SD Card in ASCII format.

 The measurement is completed.

Averaging of STI Results

The standard IEC 60268-16 recommends averaging two or three subsequent results taken at the same measurement location.

The German Standard VDE 0833-4 requires performing minimum three subsequent measurements for one measurement position in case of STI < 0.63.

The XL2-TA Analyzer offers automated averaging of two up to eight speech intelligibility results based on these standard requirements.

Start Averaging

- Select the averaging page **Avr**.

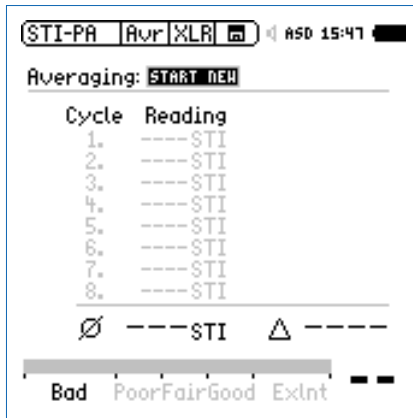

- Turn the rotary wheel to select the parameter **START NEW** and press enter .

The first measurement starts automatically. It is labeled **Cyc 1**.

Add Cycles

- Press enter to confirm **Add Cycle**.



- Repeat the measurement at the same position as required.

The XL2-TA performs further measurements and adds them to the list.

Finish

- Choose **Finish** to end the averaging.



- 👉 The speech intelligibility average and the deviation are displayed for documentation.

Display of STIPA Numeric Result Page

The symbol ∅ indicates that the averaged STI value is displayed.

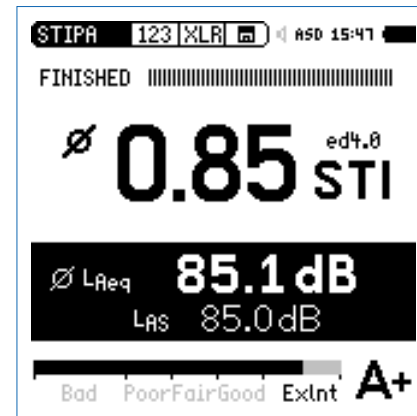

Ambient Noise Correction

Measuring the speech intelligibility index under realistic environmental conditions is often not feasible; e.g., playing the test signal in a railway station at emergency levels during peak hours will irritate passengers. Additionally, at rush-hour the characteristics of ambient noise might be highly impulsive, while a pre-requisite for accurate speech intelligibility measurements is a negligible impulsivity in the ambient noise. Under such circumstances the speech intelligibility measurement should be shifted to a more suitable time of the day; e.g. night time.

Measurement Sequence

- **First measure the ambient noise**
- **Secondly measure the speech intelligibility**



This sequence simplifies the measurement as follows: The XL2-TA immediately displays the speech intelligibility result with ambient noise correction. This result provides a guideline if repeated measurements at the same location with averaging is required. For details see the chapter STIPA Measurement Hints.

Enable Ambient Noise Correction

- Select the correction page **Cor**.
- Turn the rotary wheel to select the parameter **Ambient Noise Correction** and press enter .



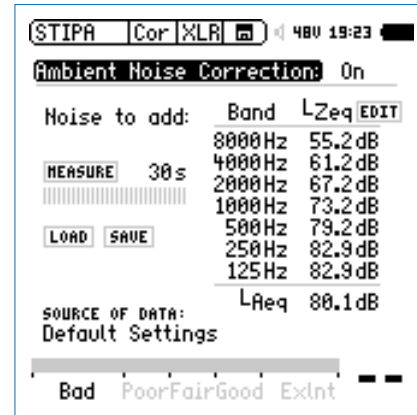

The correction enables and the XL2-TA displays this screen:



You may adjust the ambient noise band levels and the **LZeq**.

Commissioning New PA-Systems

New announcement systems are commissioned e.g. at public areas prior the grand opening. Thus, the actual ambient noise caused by the public is not available yet during the speech intelligibility measurement. Here you may simulate the real-life condition with ambient noise data enabled by one of the following modes:

- Utilize a reference noise file, which might be applicable for the actual project
 - Measure the ambient noise at another similar project and store this as reference noise file.
 - Back on the actual project select the parameter **Load** with the rotary wheel  and press enter .
 - Select the reference noise file, which shall be utilized as ambient noise correction for your speech intelligibility measurements.
- Edit actual noise data
 - Select the parameter **Edit** or the **LAeq** level with the rotary wheel  and press enter .
 - Turn the rotary wheel to adjust the noise level.
 - Press enter  to continue the setting.

Skip the next step “Measure Ambient Noise” and go to “STI Measurement”.

Measure Ambient Noise

- Position the microphone at the STIPA measurement point.
- Select **Measure** (without any test signal presence).

 The XL2-TA measures the ambient noise and displays the **LEQ** octave band result.

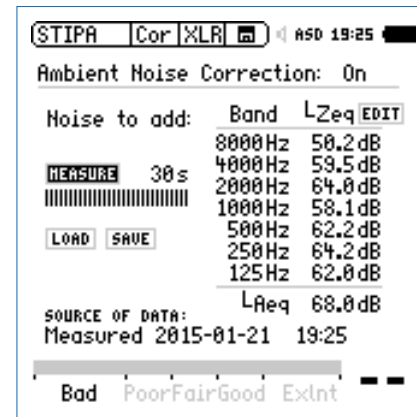

You may edit the noise data.

STI Measurement

- Select the STIPA result page **123**.
- Perform the speech intelligibility measurement.



👉 The XL2-TA displays the corrected speech intelligibility result in large font. The actual measured result is listed below in smaller font.

Data Post-Processing

In the case when no ambient noise correction has been carried out on-site with the XL2-TA Analyzer, you may post-process your measurement data on the PC. The NTi Audio STI Reporting Tool combines the speech intelligibility measurement taken with quiet conditions and the actual ambient noise caused by the public, e.g. during day-time. This emulates the speech intelligibility expected during real-life conditions.

STI Reporting Tool

The STI Reporting Tool creates measurement reports according to the standards

- AS 1670.4
- CEN/TS 54-32:2015
- DIN EN 50849:2017
- IEC 60268-16
- ISO 7240-19:2007
- VDE V 0833-4-32:2016
- VDE 0828-1:2017-11

Import the data directly from your XL2-TA including the ambient noise measurements. The corresponding speech intelligibility STI or CIS values are shown.

The STI Reporting Tool is free to download on the XL2-TA Support website <https://my.nti-audio.com> for all registered users. (Enable all macros when opening the document.)

System Requirements:

- PC running Windows OS
- Excel 2010 - 2016

STI Measurement Hints

Ambient Noise

- The ambient noise has to be sufficiently static during the measurement. A signal-noise ratio of 15 dB or higher is recommended to achieve best speech intelligibility. Impulsive ambient noise during the measurement, such as speech, causes severe measurement errors. The STIPA result is usually too high.
- Fluctuating noise is detected by measuring the direct STI in the absence of the test signal. Carry out these measurements at least at a representative set of locations. If the STI is too high (e.g. $STI > 0,3$), the measurement results are likely to be erroneous. In this case the speech intelligibility measurement should be carried out without the presence of noise.

Utilize the ambient noise correction for such instances.

- At locations with varying conditions (e.g., some public areas with few people and other areas with crowds) the worst-case speech intelligibility should be measured. Consult the local regulations (e.g. the NFPA code in the U.S.) for directives concerning measurement locations and number of required measurements under which circumstances.

German Standard VDE 0833-4 Requirements

$STI > 0.63$ One single measurement is sufficient.

$STI < 0.63$ Perform three subsequent measurements at this measurement position.

- If the maximum result deviation of these three measurements is > 0.03 then a further three measurements shall be performed.
- If the maximum result deviation of these measurements is > 0.05 then the cause of this instability shall be evaluated and removed.
- The arithmetic average of the performed three or six measurements has to be reported.

Utilize the STIPA Reporting Tool for the documentation of your measurements according to the standard.

An STI > 0.63 implies that the speech intelligibility is higher than 0.5 with a confidence level of 95%.

CD-Player

- Only high-quality CD-Players should be used to reproduce the STIPA test signal as only limited time-shifts (+/- 20 ppm) ensure reliable test results. Pitch control and shock protection should be disabled. We recommend that only professional CD-Players be used. You can verify the time shift of the CD-Player using a 1 kHz test signal:
 - Insert the NTi Audio Test CD into the CD-Player and start track 1, which is the 1 kHz test signal.
 - Connect the XL2-TA directly to the audio output of the CD-Player and measure the signal frequency in RMS/THD+N mode. The displayed frequency should be in the range from 0.99998 kHz to 1.00002 kHz
- STIPA test signals from other test system manufacturers may sound similar but are not compatible. Only the original NTi Audio STIPA test signal should be used in combination with the XL2-TA.

Measurement

- Select measurement positions as stipulated by local regulations. As a guideline, typically position the microphone at 1 - 1.2 meters above ground in sitting areas or 1.5 - 1.8 meters in standing areas. Also, directly in front of the speakers or very close to a wall are examples of positions that are not typical.
- The person taking the measurements should be out of the acoustic field, so as not to affect the measurement results. For this purpose, the measurement microphone can be mounted on a microphone stand and connected with the ASD Cable to the XL2-TA.
- Low speech intelligibility readings can be caused by
 - Excessive sound reverberation, echoes or reflections
 - Poor speaker directivity or speaker coverage
 - Speaker level setting incorrect; e.g. low signal-to-noise ratio.

6. Audio Analyzer

The XL2-TA offers a comprehensive audio analyzer. Broadband or wideband measurements are offered by the measurement functions **RMS/THD+N** and **Oscilloscope**.

The following measurement functions offer detailed analysis of the audio spectrum in Volt, dBu and dBV:

- **SLMeter/RTA**
- **FFT**
- **1/12 Oct+Tol** (optional)

Just change the measurement unit according your requirements. See the individual chapters for more details.



- If an NTi Audio measurement microphone with electronic data sheet is connected, the XL2-TA will automatically activate the unit dB SPL (dB) for sound level measurements.
- A decreased THD+N performance will occur with unbalanced input signals when using switching-type power supplies (approx. 3 dB). Remove such a mains adapter for critical applications.

RMS / THD+N

The XL2-TA Audio and Acoustic Analyzer measures the parameters Level RMS, THD+N and frequency simultaneously.

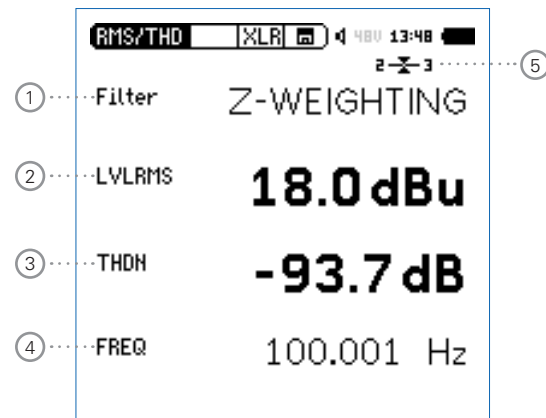

① Filter

- Z-Weighting** Frequency Z-weighting with flat frequency response from 20 Hz to 22 kHz. Default measurement setting.
- A-Weighting** Frequency A-weighting according IEC 61672 for low noise levels.
- C-Weighting** Frequency C-weighting according IEC 61672 for high noise levels.
- HP-100Hz** Highpass 100 Hz, -200 dB/dec., maximally flat magnitude filter, e.g. -60 dB @ 50 Hz
- HP-400Hz** Highpass 400 Hz, -120 dB/dec., maximally flat magnitude filter, attenuates 50/60Hz components of test signal
- HP-19k** Highpass 19 kHz; e.g., to measure a 20 kHz pilot tone level of a public address system without disturbing the public.
- 22.4-22.4k** Bandpass filter 22.4 Hz - 22.4 kHz (IEC 468-4)

② Level RMS

Measures the absolute level of the input signal. The unit's **dBu**, **dBV**, Volt **V**, **dB SPL**, Watt **W** and **dBm** are selectable. The Watt and **dBm** measurement results are calculated based on a user-defined **Load**. The unit dB SPL is not available for the type approved XL2-TA firmware.

③ THD+N

Measures the total harmonic distortion and noise of the input signal. The distortion measurement, expressed in dB, linear or in %, is conducted within the bandwidth 10 Hz - 20 kHz. This value is calculated as follows:

$$\text{THD+N} = (\text{Distortion+Noise}) / (\text{Signal} + \text{Distortion+Noise})$$

④ Frequency in Hz

The XL2-TA automatically extracts and measures the frequency of the fundamental signal. The XL2-TA frequency counter technology even reads the frequency correctly for heavily distorted signals.

⑤ Balance Indicator

Indication of the audio signal balance between pin 2 and 3 on the XLR input for input signals > -34 dBu.



The input signal is balanced.



The signal is unbalanced. The level at pin 2 is higher than at pin 3.



The signal is unbalanced. The level at pin 3 is higher than at pin 2.



PreNotch Listening

The input signal is audible at the rear speaker or headphone output.

- Press and hold down the speaker button

The pop-up window volume is displayed.

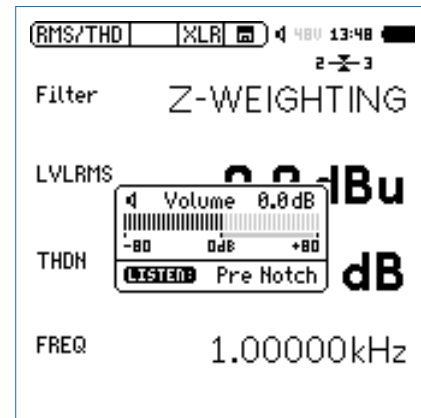

PostNotch Listening

The main frequency component is filtered out by a notch filter, leaving only the remaining signal audible.

- Press the speaker button to display the volume window.
- Additionally, press enter .

The post notch listening with auto-gain function is activated. The maximum gain setting is 0 dB.



e.g. using a 100 Hz sine test signal connected to the XL2-TA input, with the 100 Hz main frequency filtered by the notch filter, the complete frequency spectrum is available at the speaker or headphone output. This feature allows you to listen to the actual distortion signal. You therefore hear a noise from the speaker even without any connected inputs signal!



Oscilloscope

The scope function visualizes the waveform of the electrical input signal. It automatically triggers to the fundamental frequency and selects the scaling of the X-axis (time) and Y-axis (level) accordingly. The fundamental, or most dominant, frequency of the input signals is displayed above the scope screen.

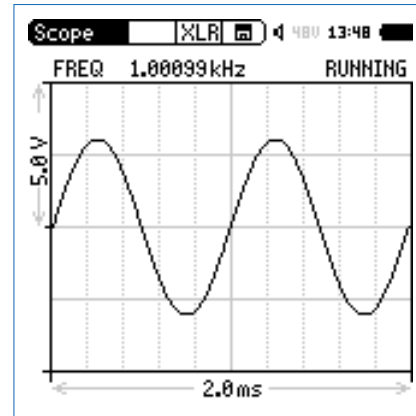

The scope scaling is fixed.

7. Vibration Meter

The Vibration Option turns the XL2-TA Audio and Acoustic Analyzer into a professional vibration meter with broadband measurements and spectral analysis in 1/3 or octave resolution. The XL2-TA Vibration Meter determines vibration acceleration, velocity and deflection with standard-compliant weighting filters in the frequency range from 0.8 Hz to 2.5 kHz. Detailed recording of measurement data and audio files allow for comprehensive evaluation and reporting. In addition, the XL2-TA Vibration Meter comes standard with an FFT analysis and an oscilloscope function. Selectable FFT frequency ranges from 1 Hz to 1.69 kHz allow a detailed examination of the measured vibrations.

The Spectral Limits Option adds functions to the Vibration Meter including a zoom FFT up to 20 kHz and a 1/12 octave band analysis from 0.73 Hz to 1.36 kHz. Also, it adds the ability to record reference spectra and set tolerances for pass / fail quality control measurements. The Remote Measurement Option allows the real-time acquisition of measurement data directly into a computer application via the USB interface. A documented command set is available.

VibMeter / Spectrum

The vibration meter offers different pages:

Page Selection using the Page Button

- Press page  to toggle between the **123 VibMeter** page and the **CPB** page.

Page Selection using the Rotary Wheel

- Select the page **123 VibMeter** with the rotary wheel .
- Confirm with enter .

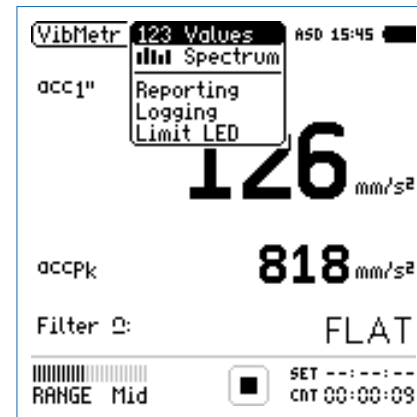

Page Selection

123 Values: Vibration Meter

Displays the selected broadband vibration level results. You can change the font size of the result. Depending on the font size chosen, the XL2-TA shows 2 up to 4 results simultaneously. The display of the actual or maximum level can be selected with the applicable frequency weighting. The peak levels PK or P-P are real peak levels.

Spectrum: Constant Percentage Bandwidth CPB

Displays the 1/3 or 1/1 octave spectrum of the selected RMS, peak or peak-peak vibration level. Additionally, the wide band result B is shown graphically by a bar.

Reporting: Report Setting

Here you set which vibration levels shall be stored in a .txt file after the completed measurement. Choose between:

ALL Stores all vibration levels.

Selected Stores up to 10 different individually-defined vibration levels.

For details refer to the chapter Reporting.

Logging: Setup of Data Logging

The XL2-TA features a powerful vibration level meter data logger, which allows you to record all required vibration level values during the measurement. In the logging page you set which vibration levels shall be logged over time. For details refer to the chapter Logging. Choose between:

ALL Logs all vibration levels.

Selected Logs up to 10 different individually-defined vibration levels.

Limit LED: Limit Setting

Here you set the function of the limit LED , thereby highlighting any vibration level that exceeds the pre-set limits in orange or red color. Further, external peripherals are controlled by the optional Serial I/O Interface based on the vibration level, such as displaying vibration levels on a large external red-orange-green lamp. For details refer to the chapter Limits.

Overview

Numeric Result Page

The numeric result page **123 Values** displays the selected broadband vibration level results. You can change the font size of the result. Depending on the font size chosen, the XL2-TA shows 2 up to 4 results simultaneously. The display of the actual or maximum level can be selected with the applicable frequency weighting.

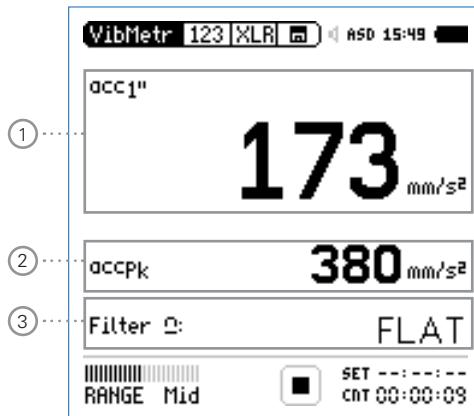

Constant Percentage Bandwidth Analyzer Page

The real-time analyzer page **Spectrum** measures and displays the 1/3 or 1/1 octave spectrum in the selected frequency range including the wideband result.

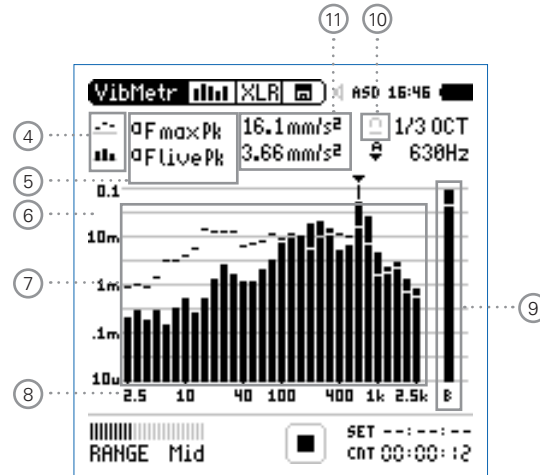

① Vibration Level Result 1

All vibration levels are measured and logged simultaneously. You select which vibration levels should be displayed.

Change Parameter

- Turn the rotary wheel to select the parameter **Lxx**.
- Press enter to open the selection menu and choose the wideband vibration level to be displayed.
- Turn the rotary wheel to select the required test result parameters and confirm with enter .

Change Font Size

- Turn the rotary wheel to select the actual test result.
- Press enter 1x, 2x or 3x to set the font size to small, medium or large.

The XL2-TA shows 2 vibration levels on the display if a large font is chosen, otherwise it shows 4 vibration levels.

② Vibration Level Result 2

Follow the setting instructions for vibration level result 1.

③ Filter

Select one of the following frequency filters:

FLAT	no filter applied
1-80Hz	Filter 1 - 80 Hz with decay rate of 12 dB / octave in accordance with DIN 45669-1
1-315Hz	Filter 1 - 315 Hz with decay rate of 12 dB / octave in accordance with DIN 45669-1
10-1000Hz	Filter 10 - 1000 Hz with decay rate of 18 dB / octave in accordance with ISO 2954

④ Result Symbols / Capture

This field offers two functions:



- Symbols for measurement results

Upper parameter displayed as line.

Lower parameter displayed as bargraph.

- Capture

One of the displayed frequency band readings may be captured. Any measurement data can then be compared with this captured reference live on the XL2-TA Analyzer.

- Select the parameter to be captured.
- Confirm with enter , to capture the reading.
- Select the upper parameter  and choose **Capt.**
- Confirm with enter .

 The lower reading can be compared with the previously-captured reference data.

Level Type





Select in the **System Settings**:

- metric or imperial units
- RMS, peak or peak-peak level

 Upper parameter displayed as line.

 Lower parameter displayed as bargraph.

Y-Scale setting

- Select the Y-Axis with the rotary wheel  and confirm with enter .
- Select the zoom factor between **20, 10, 5, 2.5 dB/div** and confirm with enter .
- Scroll up and down with the rotary wheel  to select the Y-axis range.
- Confirm with enter .

Measurement Result

Real-time analyzer results in 1/1 octave or 1/3 octave band resolution.

X-Scale setting

Third-octave band resolution

2.5 Hz - 2.5 kHz frequency band levels including wide band result

0.8 Hz - 1.0 kHz frequency band levels including wide band result





0.8 Hz - 2.5 kHz frequency band levels

Octave band resolution

4 Hz - 2.0 kHz frequency band levels including wide band result

1 Hz - 0.5 kHz frequency band levels including wide band result

1 Hz - 2.0 kHz frequency band levels

- Select the X-Axis with the rotary wheel  and confirm with enter .
- Toggle with the rotary wheel  between the ranges.
- Confirm with enter .

9 **Broadband Results**

Displays broadband level B.

10 **Filter**

Select the preset frequency filter here, which is already used on the broadband page.

11 **Measurement Result**

Actual level result of the indicated frequency band. The cursor readout displays the center frequency and the level of the band pointed to by the arrow.

Select the measurement unit as follows:

- | | |
|----------------|--|
| Acceleration a | <ul style="list-style-type: none"> • m/s² • g • in/s² • dB |
| Velocity v | <ul style="list-style-type: none"> • m/s • in/s • dB |
| Displacement d | <ul style="list-style-type: none"> • m • in • dB |

Wav-File Recording

The XL2-TA records a wav-file of the measured input signal and stores it on the SD Card. The available formats are:

- **Compressed** (default, using ADPCM compression). A new wav-file is started automatically after 12 hours of recording (typical maximum wav-file size = 512 MByte)
- **Compressed+AGC**, compressed with automated gain control. The gain control increases the level of low-level signals, so that the wav-file is well-leveled during playback on the PC.
- **24Bit_48kHz**, linear wav-file logging in 24 bit, 48kHz resolution with the optional Extended Acoustic Pack. A new wav-file is started automatically after 1 hour of recording (typical maximum wav-file size = 512 MByte)



Broadcast Wave Format BWF

The XL2-TA stores scaling factor, serial number, date, time and time zone within the wav-file (according to EBU TECH 3285). This information is available through professional audio/video tools typically used in broadcast.

Sample name of wav-file:

MyTest_V_Meter_000_Audio_FS_2.52e2_mps2(PK)_00.wav



- ① **MyTest**
File name defined by user.
- ② **SLM**
Measurement function.
- ③ **000**
Automatically incrementing file number.
- ④ **Audio_FS_2.52e2_mps2(PK)**
Audio file with full-scale peak level based on acceleration in unit m/s². In case of a **Compressed + AGC** recording, the file name reads "AGC"; this file contains corrected level information only.
- ⑤ **00**
The number increments for each successive wav-file during a longer recording.

FFT Analysis + Tolerance

The XL2-TA Vibration Meter includes a fast real-time FFT.

The following features are available upon installing the Spectral Limits Option in the XL2-TA Analyzer:

- High-resolution Zoom-FFT up to 0.4 Hz steps in the frequency range 1 Hz - 20 kHz
- Capture and tolerance function provided with Spectral Limits Option; thus the main menu function reads **FFT + Tol**.

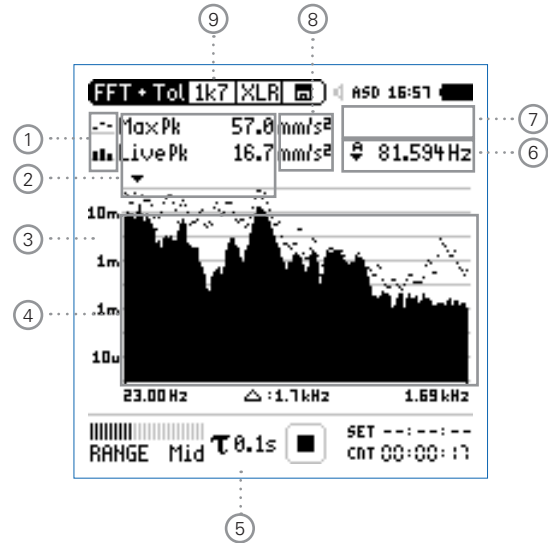

① Result Symbols / Capture & Start Tolerance Mode

This field offers two functions:

- Symbols for measurement results ②



Upper result displayed as line.



Lower result displayed as bargraph.

- Capture & Start Tolerance Mode

The displayed readings may be captured as reference reading C1 to C8 for

- Comparing measurement results against captured traces with relative or absolute curve display.
- Creating tolerance masks based on captured reference curves for passed / failed measurements.

Capture EQ Captures the upper parameter

Capture Live Captures the lower parameter

Manage captures

Allows to rename captures, clear re-recorded captures, save captures to the SD Card for export from the XL2-TA or load captures from the SD Card for import to the XL2-TA.

Start tolerance mode

Starts the tolerance mode for passed/failed measurements comparing the actual measurement results against a tolerance band.

② Measurement Result

Actual level result of the indicated frequency band. The cursor readout displays the center frequency and the level of the band indicated by the arrow.



Upper parameter displayed as line.







Lower parameter displayed as bargraph.

Select in the **System Settings**:

- metric or imperial units
- RMS, peak or peak-peak level

③ Y-Scale setting

- Select the Y-Axis with the rotary wheel  and confirm with enter .
- Select the zoom factor between **20, 10, 5, 2.5 dB/div** and confirm with enter .
- Scroll up and down with the rotary wheel  to select the Y-axis range.
- Confirm with enter .

④ Measurement Result

Displays the actual and averaged measurement results.

⑤ Time Weighting

Offers selectable time weighting of **0.1, 0.2, 0.5, 1.0** seconds as well **FAST** (125 ms) and **SLOW** (1 second).



Applications:

Short Time Weighting	High-resolution in time with minimum averaging
Long Time Weighting	Low resolution in time with longer averaging

⑥ Readout Frequency

You may select any frequency to read out individual levels. The selected frequency is indicated by the cursor arrow. Choose between the following settings:





- The cursor follows automatically the highest level, e.g. tracing the dominant frequency of a rotating part.
- Select the frequency with the rotary wheel .
- Press enter .
- You may readout any individual frequency.
- Return to auto frequency with enter .



The cursor returns to the frequency with highest level bar.









- The cursor readout may be set manually to any frequency. The readout remains at the selected frequency.
- Select the frequency with the rotary wheel .
- Press enter .
- Select the frequency of interest.
- Confirm with enter .



The cursor readout  displays the measurement results of the selected frequency band.

7 Zoom Mode

(optional, applicable with the Spectral Limits Option)

- Select the readout frequency  and press enter .
- The zoom mode is displayed above the flashing arrow.
- Select the zoom-in frequency with the rotary wheel .
- Press limit  and zoom the linear frequency scale in or out with the rotary wheel .
- Release limit  and scroll the linear frequency scale left or right with the rotary wheel .

8 Measurement Unit

Select the measurement unit as follows:

Acceleration a	<ul style="list-style-type: none"> • m/s² • g • in/s² • dBa
Velocity v	<ul style="list-style-type: none"> • m/s • in/s • dBv
Displacement d	<ul style="list-style-type: none"> • m • in • dBd

The Spectral Limits Option extends the function with captures and tolerances. All tolerances are specified as acceleration.

9 Page Selector X-Scale and Parameter Setting

- 1k7** Shows FFT result of the frequency band range. 23 Hz - 1.687 kHz in a resolution of 11.72 Hz with 143 bins shown on the display.
- 400** Shows FFT result of the frequency band range. 5 Hz - 421.02 Hz in a resolution of 2.92 Hz with 143 bins shown on the display.
- 100** Shows FFT result of the frequency band range. 1 Hz - 105.00 Hz in a resolution of 0.73 Hz with 143 bins shown on the display.
- Usr** User Range
(applicable with optional Extended Acoustic Pack or Spectral Limits Option)
1 Hz - 20 kHz in zoom mode with a minimum resolution of 0.366 Hz and 143 bins displayed.
- Set** Selection for FFT Windowing:
 - **Hann**: Default setting
 - **Dolph-Chebyshev**: for analyzing small signals (e.g. harmonics) close to a dominant signal.

The page button  switches these display modes.

Oscilloscope

The scope function visualizes the waveform of the electrical input signal. It automatically triggers to the fundamental frequency and selects the scaling of the X-axis (time) and Y-axis (level) accordingly. The fundamental, or most dominant, frequency of the input signals is displayed above the scope screen.

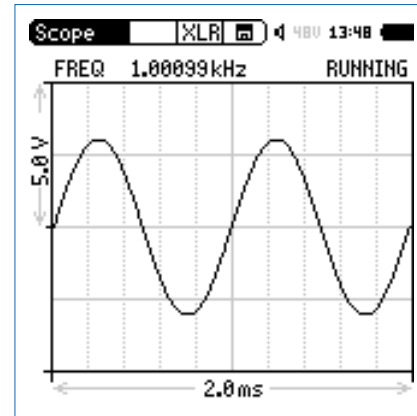

The scope scaling is fixed.

① Result Symbols / Capture & Start Tolerance Mode

This field offers two functions:

- Symbols for measurement results ②



Upper result displayed as line.



Lower result displayed as bargraph.

- Capture & Start Tolerance Mode

The displayed readings may be captured as reference reading C1 to C8 for

- Comparing measurement results against captured traces with relative or absolute curve display.
- Creating tolerance masks based on captured reference curves for passed / failed measurements.

Capture EQ Captures the upper parameter

Capture Live Captures the lower parameter

Manage captures

Allows to rename captures, clear re-recorded captures, save captures to the SD Card for export from the XL2-TA or load captures from the SD Card for import to the XL2-TA.

Start tolerance mode

Starts the tolerance mode for passed/failed measurements comparing the actual measurement results against a tolerance band.

② Measurement Result

Actual level result of the indicated frequency band. The cursor readout displays the center frequency and the level of the band indicated by the arrow.



Upper parameter displayed as line.







Lower parameter displayed as bargraph.

Select in the **System Settings**:

- metric or imperial units
- RMS, peak or peak-peak level

③ Y-Scale setting

- Select the Y-Axis with the rotary wheel  and confirm with enter .
- Select the zoom factor between **20, 10, 5, 2.5 dB/div** and confirm with enter .
- Scroll up and down with the rotary wheel  to select the Y-axis range.
- Confirm with enter .

④ Measurement Result

Displays the actual and averaged measurement results.

⑤ Time Weighting

Offers selectable time weighting of **0.1, 0.2, 0.5, 1.0** seconds as well **FAST** (125 ms) and **SLOW** (1 second).

Applications:



Short Time Weighting	High-resolution in time with minimum averaging
Long Time Weighting	Low resolution in time with longer averaging

⑥ Readout Frequency

You may select any frequency to read out individual levels. The selected frequency is indicated by the cursor arrow. Choose between the following settings:



The cursor follows automatically the highest level, e.g. tracing the dominant frequency of a rotating part.



- Select the frequency with the rotary wheel .
- Press enter .
- You may readout any individual frequency.
- Return to auto frequency with enter .



The cursor returns to the frequency with highest level bar.



The cursor readout may be set manually to any frequency. The readout remains at the selected frequency.





- Select the frequency with the rotary wheel .
- Press enter .
- Select the frequency of interest.
- Confirm with enter .



The cursor readout  displays the measurement results of the selected frequency band.

⑦ Setting of Test Result Resolution

Set the spectral result display to 1/1, 1/3, 1/6 or 1/12 octave band resolution as follows:

- Turn the rotary wheel  to select the parameter .
- Press enter  to open the selection window.
- Turn the rotary wheel  to select **1/1 OCT**, **1/3 OCT**, **1/6 OCT** or **1/12 OCT**
- Press enter  to confirm.

⑧ Measurement Unit

Select the measurement unit as follows:

Acceleration a	<ul style="list-style-type: none">• m/s²• g• in/s²• dBa
Velocity v	<ul style="list-style-type: none">• m/s• in/s• dBv
Displacement d	<ul style="list-style-type: none">• m• in• dBd

The Spectral Limits Option extends the function with captures and tolerances. All tolerances are specified as acceleration.

8. Calibration

The XL2-TA Audio and Acoustic Analyzer meets or exceeds the specifications listed in the chapter Technical Data.

Instrument Calibration

In order to maintain the high accuracy, annual calibration of the XL2-TA Analyzer and the measurement microphone is recommended. The calibration service verifies the complete product specifications, differences to the last calibration and measures the frequency response of the measurement microphone. To enquire about calibration service, follow the RMA guide lines at www.nti-audio.com.

Microphone Sensitivity

NTi Audio's ASD measurement microphones and the microphone pre-amplifier MA220 include an electronic data sheet. The Automated Sensor Detection (ASD) of the XL2-TA recognizes the sensitivity and calibration data of the connected microphone. The electronic data sheet, including the microphone sensitivity, is displayed in the menu **Calibrte**.

Environmental Conditions

The sound level meter and calibrator should be exposed to the same environmental conditions prior any calibration for the following recommended periods:

- 10 minutes after a temperature change of 10°C.
- 15 seconds after the static air pressure has changed by 5 kPa.
- 10 minutes after a humidity change of 30% without condensation.

The described calibration method and correction data apply for the following environmental conditions:

- Temperature: -10 °C to +50 °C
- Static air pressure: 65 kPa to 108 kPa
- Humidity: 25 % to 90 % r.H.
without dew from -10 °C to +39 °C

Ambient Noise

Please make sure that, during the calibration with 114 dB, the ambient noise level is lower than 89 dB.

Calibration Menu with connected Measurement Microphone

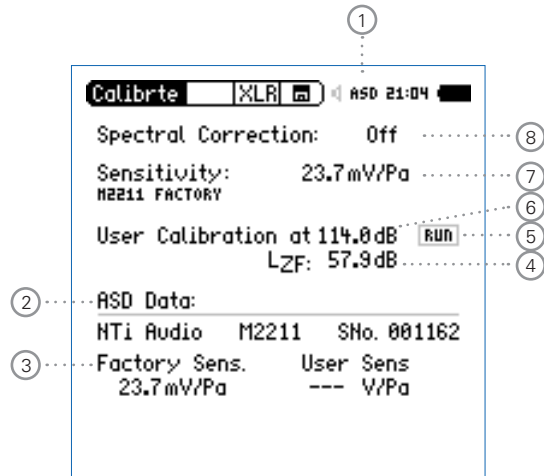

Calibration Menu without any connected Sensor

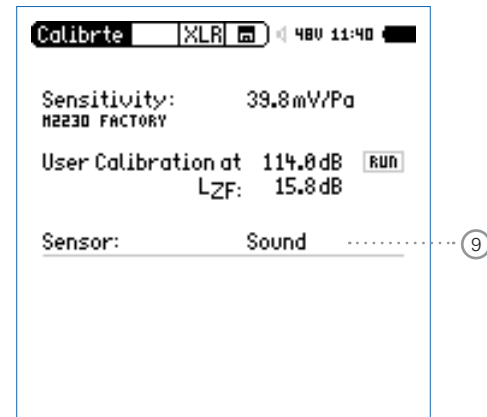

Calibration Menu with connected ICP Adapter ASD and Accelerometer

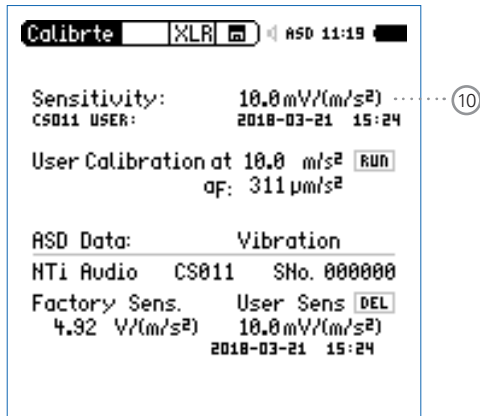

① Phantom Power Supply

48V The XL2-TA provides 48 V phantom power supply to the connection microphone or sensor.

ASD An NTi Audio measurement microphone with automated sensor detection ASD is connected. The XL2-TA reads the electronic data sheet of the microphone and switches the 48V phantom power automatically on

48V Phantom power is switched off.

② Electronic Data Sheet of Measurement Microphone

Read out data from the connected microphone.

③ Factory Sensitivity

Factory sensitivity of the connected sensor.

④ Level Type

LZF Default setting.

LHP100F Suppressing any low frequency noise, for example wind during outdoor calibrations.

⑤ Start Field Calibration

Select **RUN** and press enter to start the sensitivity setting using an external calibrator.

⑥ Level of External Calibrator

The reference calibration level is 114 dB. The XL2-TA Supports a level setting between 0 dB and 200 dB.

⑦ Sensitivity

Applicable microphone sensitivity in the range from 1 μ V/Pa to 9.99 V/Pa. The sensor detection of the XL2-TA reads the sensitivity automatically from the electronic data-sheet of the connected NTi Audio microphone or preamplifier.

⑧ Spectral Correction

Select one of the spectral corrections as applicable. This selection can be activated in the System Settings Set page at position ⑪. The correction data is listed in chapter Technical Data.

Off no spectral correction.

WP30 1/2" for horizontal noise incidents using the WP30 Weather Protection
Community

⑧ **WP30 1/2"** **Aircraft**

for vertical noise incidents using the WP30 Weather Protection; no spectral correction applies

WP61 1/4" **Community**

for horizontal noise incidents using the WP61 Weather Protection

WP61 1/4" **Aircraft**

for vertical noise incidents using the WP61 Weather Protection; no spectral correction applies

M22xx DF 1/2" Diffuse-field correction for measurement microphones M2230, M2340, M2215, M2211

M42xx DF 1/4" Diffuse-field correction for measurement microphone M4261

⑨ Selection Sound Level Meter / Vibration Meter

Sound Sound Level Meter

Vibration Vibration Meter







10 Unit Selection Accelerometer Sensitivity

The accelerometer sensitivity is provided in the range of

- 1 $\mu\text{V}/(\text{m}/\text{s}^2)$ - 10.0 $\text{V}/(\text{m}/\text{s}^2)$ or
- 10 $\mu\text{V}/\text{g}$ - 100 V/g

Field Calibration - With External Sound Calibrator



Field-sensitivity setting for measurement microphones with an external calibrator.

- Turn the rotary wheel  to select the parameter **User Calibration**  and press enter .
- Set the calibration level according to the calibrator used.
- Generate the specific reference signal with the calibrator onto the microphone.
- Turn the rotary wheel  to select the parameter **RUN**  and press enter .
- The pop-up window **Calibration: Calibration running ...** appears and changes to **Calibration: Successfully finished!** for a successfully completed calibration.

Field Calibration - Manual Sensitivity Setting

In case no external calibration device is available, set the sensitivity of non-NTi Audio sensors manually according to the product specifications as follows:

- Select **Sensitivity**  with the rotary wheel .

- Press enter  and adjust the sensitivity with the rotary wheel .
- Confirm with enter .

Field Sensitivity

The XL2-TA writes the field-sensitivity setting onto the electronic data sheet of the connected NTi Audio measurement microphone, microphone preamplifier or ASD Adapter. All subsequent measurements automatically utilize this field-sensitivity.

In case the measured sensitivity deviates ± 1.5 dB for a class 1 microphone and ± 3 dB for a class 2 microphone to the nominal microphone sensitivity, then the XL2-TA displays the following message: **Measured sensitivity to far (xxdB)from factory settings. Check calibration level and microphone!**

In doubts kindly contact NTi Audio with the details.



Free-field Correction

The following free-field correction shall be applied using the NTi Audio Class 1 Sound Calibrator

- M2230, M2340, M2211, M2215: -0.1 dB

The following correction shall be applied using the NTi Audio Class 1 Sound Calibrator with 1/4" adapter ADP 1/4-P

- M4260: +0.1 dB
- M4261: +0.2 dB

The NTi Audio microphones are free-field equalized measurement microphone. Thus, they already compensate the increased level by the presence of the microphone body in the free-field. Pressure conditions apply during the calibration. Therefore, the level in front of the 1/2" microphone diaphragm differs by -0.08 dB with reference ambient conditions.

- M2230 with 50 mm Wind Screen
The correction value is +0.12 dB and the XL2-TA has to be set to a calibration level of 114.0 dB (=114-0.08+0.12).
- M2230, M2340 with 90 mm Wind Screen
The correction value is +0.19 dB and the calibration level on the XL2-TA has to be set to 114.1 dB (=114-0.08+0.19).
- M2230, M2340 with WP30 Wind Screen 90 mm
The correction value is +0.19 dB and the calibration level on the XL2-TA has to be set to 114.1 dB (=114-0.08+0.19).

Example - Field Calibration

- Configuration
 - XL2-TA + M2230 Measurement Microphone
 - NTi Audio Class 1 Sound Calibrator @ 114.0 dB
- The level ① at **User Calibration** shall be set to 113.9 dB (=114.0 - 0.1).

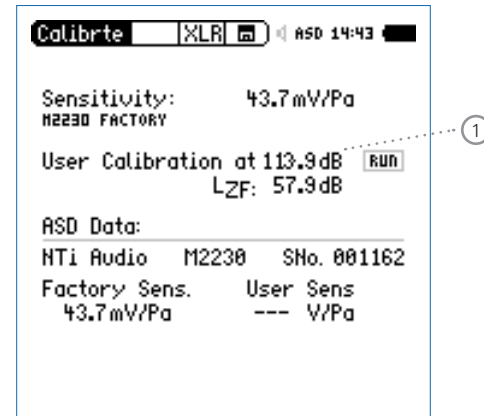

- Select the parameter **RUN** and press enter ↵.

👉 The field calibration is completed.

Applying Correction Values @ M2230

The goal is to measure the sound pressure without the influence of the microphone in the air. However, the presence of the microphone body in the free-field environment affects already the sound pressure level at high frequencies. The measurement microphone acts at high frequencies like a reflector. The sound pressure increases in front of the microphone capsule membrane. For example, the sound pressure level is 114.0 dB in the free field prior installing the microphone. Now the measurement microphone is placed into the free field. The pressure in front of the capsule is increased by 0.1 dB at 1 kHz. However, since the sound without microphone influence shall be determined, the free-field equalization of the M2230 compensates this effect. The XL2-TA Sound Level Meter reads the accurate measured value of 114.0 dB and not 114.1 dB.

If the Class 1 Sound Calibrator is placed on the M2230 measurement microphone, then the pressure conditions applies to the microphone capsule. The pressure in the volume of the calibrator matches the pressure on the membrane surface of the microphone. Now the free-field equalization and the pressure conditions for the calibration have to be taken into account. Thus, the XL2-TA has to be adjusted to a calibration level of 113.9 dB when using the M2230. This applies for calibrations at reference ambient conditions and an accurate calibrator output level at the reference sound pressure level.

9. Profiles

Profiles are templates of measurement setups. You may define which profile is loaded at startup, so that the measurements are carried out always with the same setup and instrument settings.

A remarkable advantage of the XL2-TA is the flexible user interface. The measurement screens may be personalized and only a limited subset of the comprehensive functionality enabled to create simplified operator interfaces. Advanced users may access all menus, settings and store their preferred measurement configurations. For simplicity the XL2-TA Audio and Acoustic Analyzer offers fixed operator interfaces with specific pre-defined settings. The XL2-TA can boot up with exactly the required measurement parameters according to the pre-defined instrument configurations. This ensures accurate measurements are achieved in both advanced and basic usage environments.

Profiles - Getting Started

Activate Profile Selection at Startup

- Select **Show profile list** ① in the **System** menu.
- Press enter ↵ to activate **Yes**. This will show the profile list at startup.

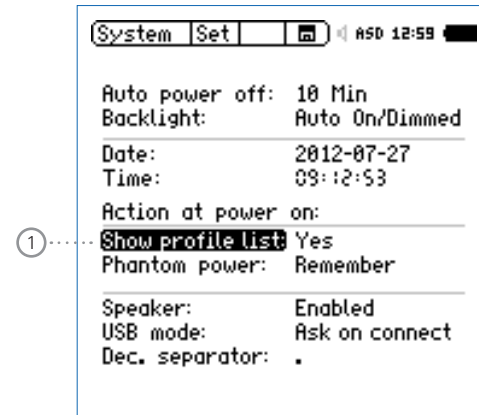

- 👉 The profile list is shown next time you power up the XL2-TA.

Preset Measurement Function

- Start the XL2-TA Analyzer in **Full mode**.
- Select the typically-used measurement function and adjust the measurement parameters according to the requirements.

For example, measuring the sound levels L_{AF} , L_{Aeq} and L_{AFmax} for 10 seconds:

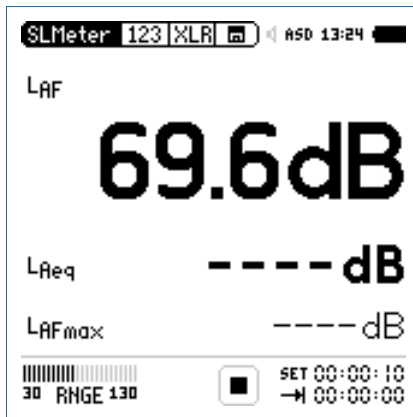

Store MyProfile

- Select **Profile** in the main menu and press enter ↵.

👉 The profile menu opens.

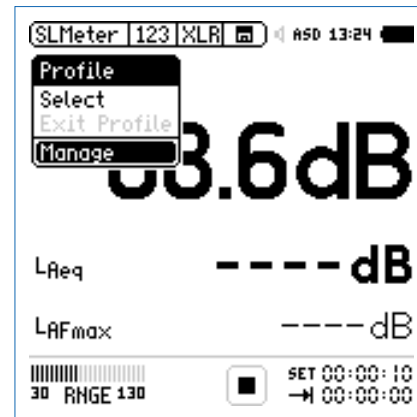

- Select **Manage** and press enter (↵).

👉 The **Manage Profile** menu opens.



- Select **Save Profile** and press enter (↵).

👉 The **Save Profile** menu opens.





Each stored profile includes all settings of all measurement functions and pages. Only the following details are not stored:

- Calibration settings
- System settings
- Temperature unit
- Phantom power on/off

- Select **Rename** and press enter (↵).
- Set the profile name to **MyProfile**. The maximum name length is 20 characters.

- Select **Configure available screens** and press enter ↵.



- Select additional available pages/measurement functions for the profile; e.g. RTA .
- Press escape  to return to the **Save Profile** screen.
- Set **Append mode available: yes** in order to have the append data feature available in the memory menu .
- You may enable manual measurement range setting within your profile. Select **Allow manual ranging: yes**.
- The correction values defined in **KSET** may be part of the profile for selectable profiles with different corrections.
- Select **Save** and press enter ↵.

Select Profile at Startup

- Switch on the XL2-TA 

👉 The profile selection is shown on the display.

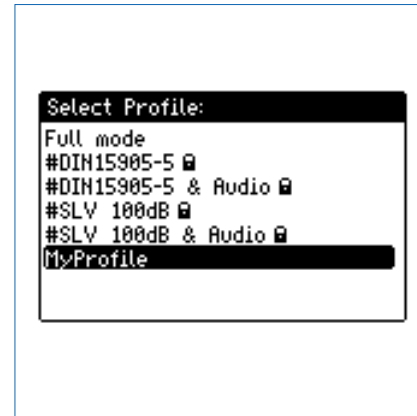

- Select the profile **MyProfile** and press enter ↵.

👉 The XL2-TA starts up with the pre-configured settings for sound level monitoring.

Select Profile during Operation

- Select **Profile** in the main menu and press enter ↵.

👉 The profile menu opens.

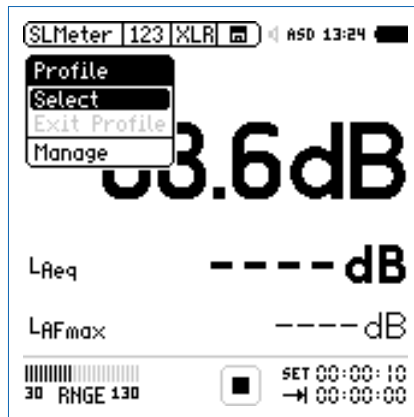

- Choose **Select** and load the required profile.

Run Measurement

The profile name is displayed when a measurement function is highlighted. The main menu offers only the measurement functions enabled by the profile, plus the calibration and profile menu.

- Press start ▶■.

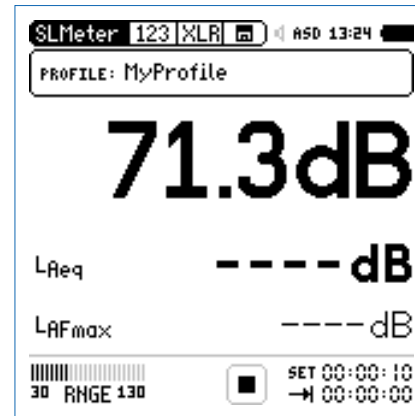

- Wait 10 seconds until the measurement is finished.
- To return to the full mode either switch off the XL2-TA 📶 again or select **EXIT Profile** in the main menu.

Export MyProfile to PC

If you have two or more XL2-TA Audio and Acoustic Analyzers, you may like to transfer the same profiles to the other instruments.

- Select **Profile** in the main menu and press enter
- Select **Manage** and press enter
- Select **Export to SD-Card** and press enter

The XL2-TA generates a folder on the SD Card called “Profiles”. All available profiles are exported into this folder.

- Connect the XL2-TA to the PC.
- Copy/paste the profile called **MyProfile** to the PC.

Import MyProfile from PC

- Connect another XL2-TA to the PC and generate a folder called “Profiles” on the SD Card.
- Copy the profile called **MyProfile** into the folder “Profiles”.
- Start up the XL2-TA, select **Profile** in the main menu and press enter
- Select **Manage** and press enter
- Select **Import from SD-Card** and press enter

MyProfile is available on the other XL2-TA Analyzer.





If the profile is exported from an XL2-TA Analyzer with activated options to another XL2-TA Analyzer without options, then these options have to be hidden prior to storing the profile for export:

- In the exporting XL2-TA system menu, select the individual option and toggle with enter to **Hidden**.
- Store the profile in the XL2-TA Analyzer.

The XL2-TA can store up to 20 individual profiles in the internal system memory and offers three different profile types:

Types	Description
Factory default profiles	<p>The XL2-TA includes factory default profiles, which are marked with “#” in the beginning of the file name. Sample filename: #DIN15905-5.prfs</p> <p>The factory default profiles are a free download for all registered XL2-TA customers on the support website at https://my.nti-audio.com. For details see the chapter My NTi Audio.</p> <p>For detailed settings of factory default profiles please see the Appendix 2 in this manual.</p>
User profiles	<p>User profiles are profiles generated by you on the XL2-TA Analyzer. Sample filename: MyProfile.prf</p>

<p>Secured profiles</p>	<p>Secured profiles are locked user profiles with overwrite protection indicated by the file name ending in “xxx.prfs”. This file name cannot be overwritten. Sample filename: MyProfile.prfs</p> <p>How to generate secured profiles</p> <ul style="list-style-type: none"> • Export the profiles to SD Card according to the procedure in the chapter Profile - Getting Started. • Connect the XL2-TA to the PC. • Select the user profile in the folder “Profile”. • Manually change the ending of the user profile from “xxx.prf” to “xxx.prfs” • Disconnect the XL2-TA from the PC. • Import the profiles from the SD Card • Power off/on  the XL2-TA Analyzer <p> The secured profile is displayed with a lock-symbol in the profile selection window on startup of the XL2-TA.</p>
-------------------------	--

10. Spectral Limits Option (Capture + Tolerances)

The Spectral Limits Option extends the function range of the XL2-TA with trace capturing, relative curve display and comprehensive tolerance handling for the **FFT** Analysis and the high-resolution **1/12 Oct + Tol** spectral analysis.

Features:

- Capturing of multiple readings into the internal memory
- Comparing measurement results against captures with relative or absolute curve display
- Comprehensive tolerance handling
- Creating tolerance masks based on captures for passed / failed measurements

Capture the EQ Measurement Results

- Select the Capture & Start Tolerance Mode symbol for capturing the measurement result.

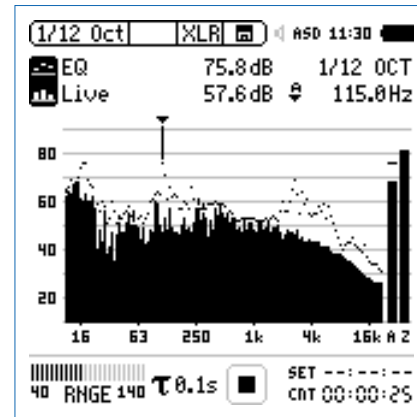

- Confirm with enter ↵.

👉 A pop-up window appears.

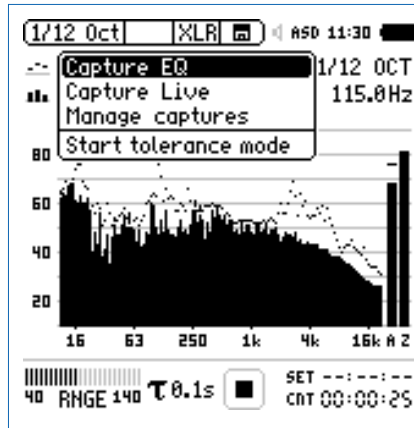

- Select **Capture EQ**.
- Confirm with enter ↵.

👉 The pop-up window ... **and store it to** appears.

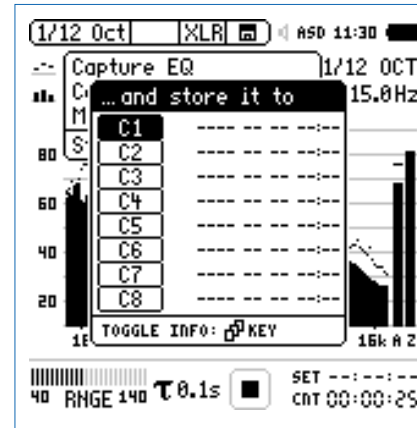

- Select **C1**.
- Confirm with enter ↵ and set the capture name in the displayed letter selection box e.g. to **Ref**.

👉 The capture has been stored in the internal XL2-TA memory.

Edit Capture Manually

- Select the Capture & Start Tolerance Mode symbol.
- Confirm with enter ↵.
- Select **Manage captures**.
- Confirm with enter ↵.
- Select **Save to SD card**.

👍 The pop-up window **Save captures** appears.

- Select the capture to be exported, e.g. **C1**.

👍 The pop-up window **Save capture C1 to** appears.

- Confirm with **Save**.

👍 The XL2-TA generates the file MyCapture.txt in a new folder called Captures.

- Edit the sound level data in the capture file. All frequency data has to remain the same.
- Load the new capture file with **Manage captures** back into the internal XL2-TA memory.

See the difference between Live Level and Capture

- Blank the upper parameter by setting ----.
- Select the lower parameter with the rotary wheel ⌚.
- Confirm with enter ↵.
- Select **Live** and confirm with enter ↵.

👍 The pop-up window **Select reading mode** appears.

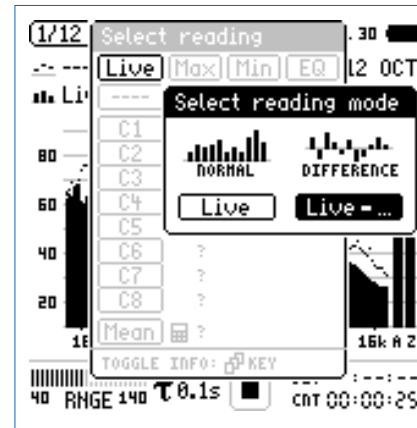

- Select **Live -** for displaying the relative difference.
- Confirm with enter ↵.
- Select **Ref** and confirm with enter ↵.
- Set the Y-axis accordingly to show the zero-line.

👉 The relative difference between the Live level and the captured reference is displayed.

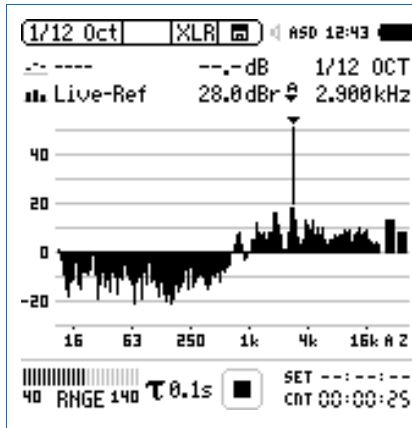

All levels differences (relative levels) are displayed in the unit **dBr**.

Manual Editing of Capture Data

Kindly observe the following rules while manually editing capture data:

- The spectral level data is Z-weighted, thus the sum of all bands has to equal the Z-weighted broadband level.
- The A and C-weighted broadband levels are calculated observing the corresponding correction factors.
- Enter -999 if nothing shall be deducted at certain broadband levels or frequency bands.

%-----EDIT ONLY LEVELS HERE!-----	
#A-weighted broadband level	32.74
#C-weighted broadband level	-999
#Z-weighted broadband level	33.17
#Columns	
Frequency	Level
#Spectrum	
16	-999
31.5	-999
63	-999
125	10.5
250	20.5
500	25.7
1000	28.6
2000	25.5

Start Tolerance Mode for Passed/Failed Measurements

- Select the Capture & Start Tolerance Mode symbol with the rotary wheel .

 A pop-up window appears.

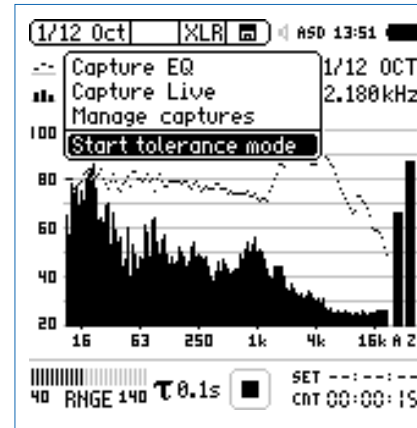
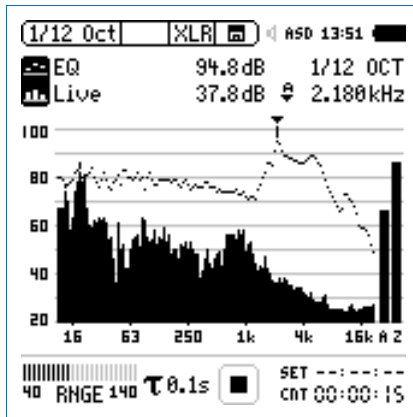

- Confirm with enter .

- Select **Start tolerance mode**.
- Confirm with enter .

👍 The pop-up window **Make tolerance from** appears.

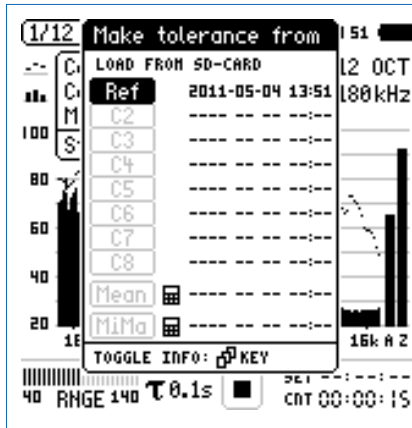

- Select **Ref** to load the earlier captured reference spectrum.
- Confirm with enter (↵).



You may press the page button  to toggle between the date and spectral resolution data of the capture.

Passed Result

👍 The tolerance mode is active for passed/failed measurements.

The passed/failed condition is further visualized by the bicolor “limit” button and forwarded to the I/O interface of the instrument in order to drive an external alarm device such as the accessory SPL Stack Light.

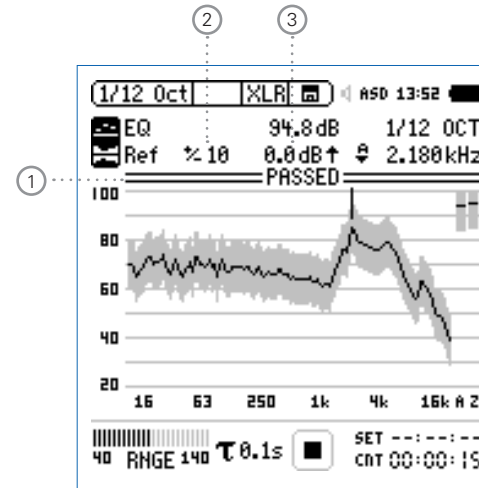

① PASSED / FAILED Result

PASSED The actual measurement result is within the tolerance band.



The actual measurement result is outside of the tolerance band. Exceptions are visualized in any out-of-tolerance frequency band.

② Tolerance Bandwidth

Adjusts the tolerance bandwidth based on the captured reference spectrum in dB.

③ Level Offset

Provides a level offset in dB to shift the tolerance band up or down.

Failed Result

The XL2-TA Analyzer compares spectral measurements against a tolerance band and visualizes exceptions ① in every frequency band.

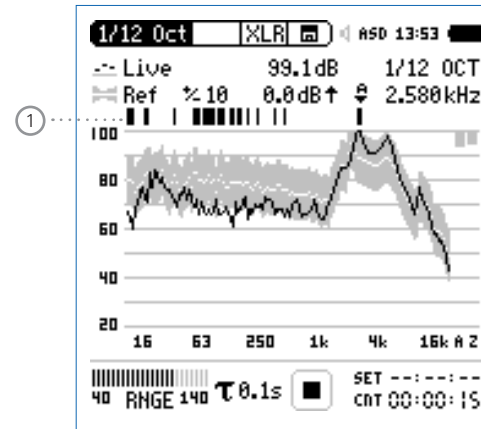

Select another Tolerance File

- Select the tolerance **Ref** with the rotary wheel
- Confirm with enter
- Select the new tolerance file from the SD Card or the internal XL2-TA memory.

Tolerance Menu

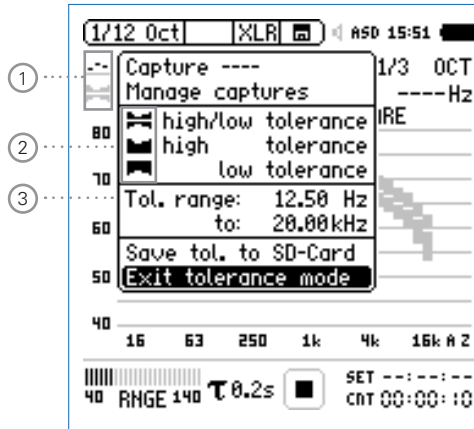

- ① **Capture & Start Tolerance**
Opens capture and tolerance menu.
- ② **Tolerance Type**
Select between high/low, high or low tolerance band based on the reference data set.
- ③ **Frequency Range**
Setting of start and stop frequency of the tolerance band.

Advanced Start Functions

You may start the passed/failed measurement in one of the following ways:

- Press the XL2-TA start button
- Activate the automated level trigger in the tolerance file.
- Activate the digital input 1 via the external I/O interface; e.g. a foot switch or a PLC control.

Digital I/O Interface

Result Passed:	Output 1
Result Failed:	Output 3
Start Measurement:	Input 1

Tolerance Management

Tolerance curves can either be imported from txt-files or directly derived from captured measurements. The XL2-TA calculates tolerance bands based on

- Single captured results
- txt-files generated manually on a PC
- Mean average of multiple captures
- Min/Max curves of multiple captures

Create Tolerance Files Manually on PC

- Capture a spectrum on the XL2-TA Analyzer.
- Enter the tolerance mode and generate a tolerance band for the capture.
- Select the Capture & Start Tolerance Mode symbol.
- Confirm with enter ↵.
- Select **Save tol. to SD Card** to export the capture tolerance file. This file includes the reference capture and the tolerance data. The XL2-TA generates a txt-file in the folder "Tolerances".
- Open the capture tolerance file with a text editor or MS Excel.
- Edit the tolerance data according to your requirements. Change only the Min, Ideal and Max column values. You may delete rows, but do not change the frequency column values. Any rows where frequency column values have been changed will be discarded by the XL2-TA.
- Store your individual tolerance file as a txt-file in the XL2-TA folder "Tolerances".
- Start the XL2-TA tolerance mode and load the new tolerance file from the SD Card.



- All entries in the customized tolerance file need to be tab-separated.
- The individual tolerance file entries may be in any order; no sequential order required.
- Tolerance file templates and standardized tolerance files are a free download for all registered XL2-TA customers on the support website at <https://my.nti-audio.com>. For details see the chapter My NTi Audio in this manual.

Band-limited Measurement Range

Alternatively to the settings on the XL2-TA, the tolerance may also be limited to a range of frequency bands or a number of individual frequencies on a computer.

- Open the tolerance file on the computer.
- Delete all not required frequency bands.
- Set **#Hide UnusedBands** to **True**.
- Save the file changes.
- Load the updated tolerance file in the XL2-TA.

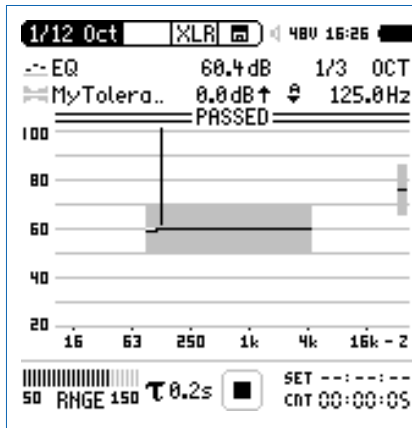

The XL2-TA shows selectable broadband values with A, C or Z-weighting on the right-hand side of the spectrum.

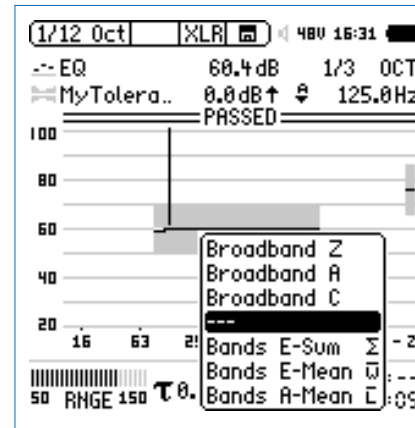

Alternatively select the following averaged or summed levels:

- **Bands E-Sum**: Sum of displayed frequency bands
- **Bands E-Mean**: Energy-averaged level of displayed frequency bands, e.g. the bands 80 dB and 70 dB produce 77.4 dB.
- **Bands A-Mean**: Arithmetically-averaged level of displayed frequency bands, e.g. the bands 80 dB and 70 dB produce 75 dB.

```

#Unit
dBr

#Mode
HighLow

#Columns
Frequency  Min           Ideal  Max

#ATolerances
UNDEF           80  undef  90

#ZTolerances
UNDEF           80  undef  90

#BandTolerances

| 20    | 70 | undef | 80 |
|-------|----|-------|----|
| 1000  | 70 | undef | 80 |
| 1000  | 73 | undef | 77 |
| 4000  | 73 | undef | 77 |
| 4000  | 70 | undef | 80 |
| 20000 | 70 | undef | 80 |



#LevelOffset
0

#HideUnusedBands
false

#nAllowedViolations
0

```

- #Unit** dBr (relative), fixed setting
- #Mode** Describes tolerance type; the XL2-TA allows setting of the tolerance type independently of the tolerance file.
- HighLow** Utilizes upper and lower tolerance based on ideal reference.
 - High** Utilizes only upper tolerance based on ideal reference.
 - Low** Utilizes only lower tolerance based on ideal reference.
- #Columns** Column headings for further tolerance data separated into columns:
Frequency / Min / Ideal / Max
- #ATolerances** Defines the tolerance band for the A-weighted wideband level (not mandatory).
- #CTolerances** Defines the tolerance band for the C-weighted wideband level (not mandatory).

#ZTolerances Defines the tolerance band for the Z-weighted wideband level (not mandatory).

#BandSum Tolerances Defines the tolerance band for the sum of displayed frequency bands (not mandatory).

- #Band Tolerances**
- Defines the tolerance band for the individual frequencies.
 - The ideal parameter can be set as "undef".
 - The same frequency value on two successive rows defines a tolerance step, e.g.:

Frequency	Min	Ideal	Max
100	70	75	80
500	70	75	80
500	75	80	90
1000	75	80	90

#LevelOffset All levels in the tolerance file are relative levels dBr. Thus, the level offset provides the relation between the relative level and actual sound pressure level. (not mandatory)
The XL2-TA allows setting of the level offset independently of the tolerance file.

#Hide UnusedBands Defines the way measurement results are shown.



True Measurement results of frequency bands without any specified tolerance are not displayed. The total level of all shown bands (sum of bands) is available as a broadband result.

False The measurement result of all frequency bands are shown.

#nAllowed Violations Allows a **PASSED** result with a maximum number of n failed frequency bands (not mandatory)

#FreqScale Spacing	<p>Defines the frequency scale spacing in the X-axis for the tolerance data. (not mandatory)</p> <p>lin Tolerance data displayed with linear frequency spacing, e.g. used in the FFT function. (default setting)</p> <p>log Tolerance data displayed with logarithmic frequency spacing e.g. used in the 1/12 Oct + Tol function.</p>	#AutoStartTriggerLevel	<p>Sets the sound level in dBZ for an automated level trigger; the passed/failed measurement starts as soon as the set level e.g. 95 dB is reached or exceeded. The actual input level can be monitored at the input range bar. (mandatory if #AutoStart is True)</p>
#AutoStart	<p>Enables auto start function. (not mandatory)</p> <p>True Auto start is active. The run indication displays A. The measurement starts automatically after the trigger level is reached. Alternatively the measurement may start manually by pressing start .</p> <p>False No auto start function. (default setting)</p>	#AutoStartSettlingTime	<p>Defines the settling time, after the auto start trigger level is exceeded, until the start of the measurement; the time is set in 100 millisecond steps e.g. setting 0.5 equals a settling time of 0.5 seconds. If the input level drops below the auto start trigger level during this period, no measurement is carried out. (not mandatory)</p>
		#MeasTime	<p>Defines the measurement time in 100 millisecond steps; e.g. setting 1.5 equals a measurement period of 1.5 seconds. (not mandatory)</p>
		#FailDeadTime	<p>Defines the delay for a failed condition in seconds; for example, the XL2-TA triggers "failed" if the measurement result is beyond the tolerance limits for e.g. 60 seconds. This feature supports condition monitoring applications. (not mandatory)</p>

11. System Settings

The various system settings of the instrument can be adjusted as follows: Turn the rotary wheel  to navigate to the main menu  and select **System**. Confirm with enter .

Settings

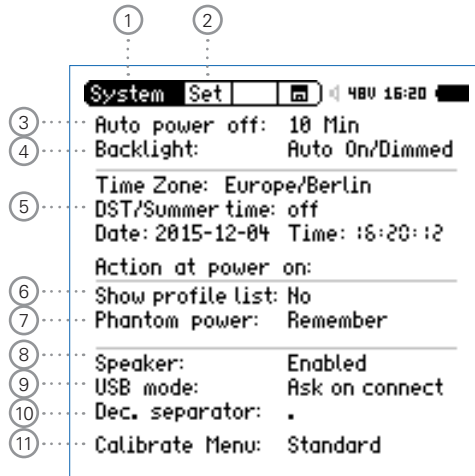

② Page Selector

Toggles with the page button  between

Set System setting

Vib Vibration (applicable only upon installing the Vibration option and selecting the vibration menu)





Sch Scheduler

Opt Options

Inf System information

③ Auto power off

If no button has been pressed for the defined time period, then the instrument switches off. The auto power off mode is disabled when a measurement is running or when an external mains power supply is used.

- Select **Auto power off** with the rotary wheel .
- Confirm with enter .
- Set the auto power off time with the rotary wheel .
- Confirm with enter .

④ Backlight

Toggle the backlight with the power/backlight button .
The backlight offers three different conditions:

- On
- Dimmed
- Off

Auto On/Off The backlight switches off if no key is pressed for 2 minutes.

Auto On/Dimmed The backlight dims if no key is pressed for 2 minutes.

Manual The backlight can be toggled between On, Dimmed and Off.

- Navigate the cursor to the backlight function.
- Toggle with enter to set this parameter.



Dimming the backlight reduces the power consumption.

⑤ Date and Time Setting

The XL2-TA includes a real-time clock. All measurements are logged with a date and time stamp.

Time Zone Select your time zone

DST/ Summer time Activate this for daylight saving

Date Date in yyyy:mm:dd

Time Time in hh:mm:ss

Set the real-time clock as follows:

- Select the **Date** function with the rotary wheel .
- Confirm with enter .
- Set the date with the rotary wheel .
- Confirm each setting with enter .
- Follow the same procedure for **Time**.

You have set the real-time clock.

⑥ Show Profile List

You may configure the XL2-TA to start up with individual preset application profiles. For example, sound level monitoring in accordance with DIN 15905 or V-NISSG.

Yes The instrument starts up with default application profiles. Further details about the application profiles are in the chapter Profiles.

No The instrument starts up in the last configuration without any application profiles.

⑦ Phantom Power

You can select if the phantom power should be activated or disabled when the XL2-TA is powered up.

Off The phantom power is switched off when the XL2-TA is powered up; e.g. when it is common to measure lines.

Remember The XL2-TA remembers the setting prior to the last shutdown. (= default setting)

⑧ Speaker

Enables/disables the rear speaker. For example, it is recommended that the rear speaker be disabled for all acoustic measurements. This prevents measuring the audio feedback sound loop generated through the rear speaker.

⑨ USB Mode

This defines how the PC recognizes the connected XL2-TA:



Ask on connect Select either the Mass storage or COM port mode after connecting the XL2-TA to the PC.

Mass storage The PC recognizes the XL2-TA as a mass storage device automatically, allowing you to download XL2-TA measurement reports.

COM port The PC recognizes the XL2-TA as a COM port automatically for application of the XL2 Projector PRO and the Remote Measurement Option.

⑩ Decimal Separator

Set the decimal separator to match the generated measurement reports to the PC settings. This simplifies data post-processing on the PC.

- Navigate to the **Dec. Separator** function ⑧ with the rotary wheel .
- Toggle between “ . ” and “ , ” with enter  to set this parameter.

 The decimal separator is set.

⑪ Calibration Menu Setting

Setting of the calibration menu.

Standard The default calibration menu is displayed.

Show Spec. Corr. This setting is required to activate the required weather protection or diffuse-field correction in the calibration menu.

Vibration

This page is available upon switching to the vibration menu, which requires an installed Vibration-Option. Vibration is selected in the calibration menu.

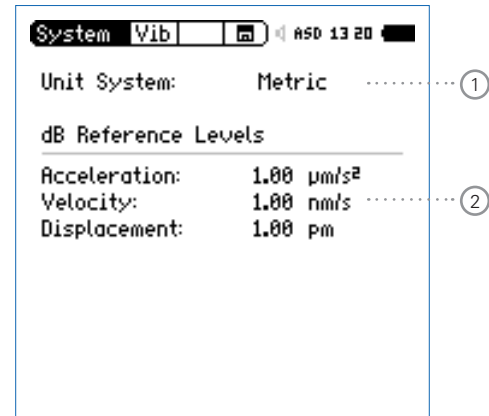

① Selection Metrical-Imperial Units

Units selection

② dB Reference

Definition of the reference parameters for dB results

Scheduler

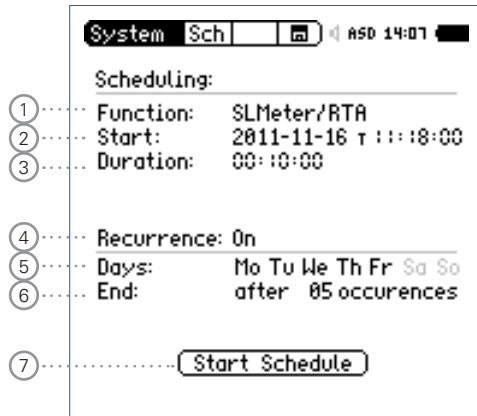

The XL2-TA Analyzer offers automated scheduled measurements without any human interaction. You may schedule a measurement for one or multiple days or ever.

XL2-TA Actions after pressing Start Schedule

- Selects the preset measurement function.
- Standby until start time
- Starts measurement at start time
- Stops measurement after the preset measurement duration
- Stores measurement data to SD Card (no reconfirmation required)
- Stops schedule or standby until next start time.

Supported measurement functions:





- SLMeter/RTA
- FFT + Tol
- RT60
- 1/12 Oct + Tol
- STIPA

① Function



Select the measurement functions for the scheduled measurements.

② Start Date and Time

Set the date for the scheduled measurement(s):

- Select **Start** with the rotary wheel .
- Confirm with enter .
- Set the date with the rotary wheel .
- Confirm each setting with enter .

Set the time for the scheduled measurement:

- Select the **T** symbol to the right of the date.
- Confirm with enter .
- Set the time with the rotary wheel .
- Confirm each setting with enter .

③ Scheduled Duration

Set the scheduled duration of the measurement(s). The actual settings of the selected measurement function apply.

④ Recurrence

Off Schedules a single measurement.

On Schedules a measurement sequence with the same start and end time for the selected days.

⑤ Days

Select the week days for the recurrence

⑥ End

Set the number of occurrences of the scheduled measurement. Each week day is one occurrence. Select between 1 to 99 occurrences or an endless schedule (= never).

⑦ Start Schedule

Starts the scheduled measurement(s).

 The **Scheduler active** window is displayed.

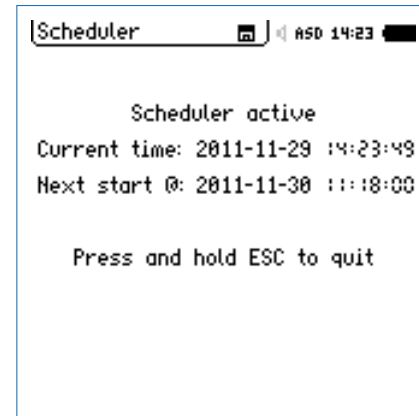

Scheduling - Getting Started

After starting the scheduled measurement, the XL2-TA waits for the next scheduled start date and time. The instrument buttons are disabled.

Power Supply

It is recommended that the instrument remains powered on until the next start time, using the accessory mains power adapter. If the XL2-TA is powered off and on again during this time, then the XL2-TA Analyzer restarts in the **Scheduler** function and continues the countdown. This applies also for any interruption of mains power supply.

Stopping the Scheduler

Press and hold the start/stop button  to stop the scheduler prior to the start of the measurement or as an interrupt of any ongoing scheduled measurement.

Operation with PC

Starting the schedule switches the USB interface automatically into the COM port mode for remote measurement applications or using the XL2 Projector PRO software.

Options

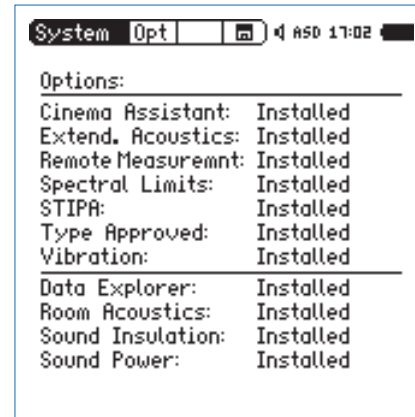

Displays the options installed on the XL2-TA.

Every installed option may be temporarily **Hidden** to generate a profile for other XL2-TAs without this option installed.

- Select the installed option.
- Toggle with enter  to set this parameter.

Information

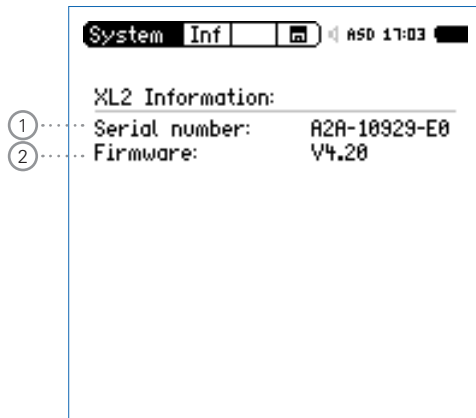

① Serial Number



Displays the instrument's serial number.

② Firmware

Displays of the firmware version number (to update the firmware to the latest version see the chapter Firmware Update of XL2-TA).

12. Data Management

The XL2-TA stores all acquired measurement data including real-time information onto the removable SD Card. Additionally, wav-files might be recorded and individual voice notes added for a complete documentation of the measurement.

- Carry out a sound level measurement.
- Select the memory menu  in the upper menu bar.
- Press enter . The memory menu opens.

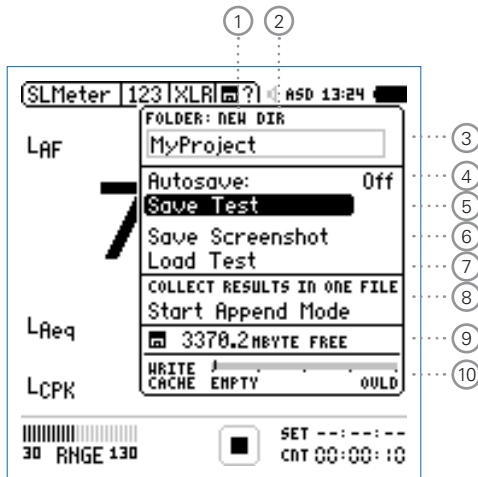

① Create New Project Folder

Add a new folder with an individual project name. The maximum length of the project name is 16 characters. A fast way for creating new folder names is

- Select an existing folder name with **DIR**
- Select **NEW**
- Rename the folder and confirm with start , thereby creating a new folder name.

② Select Project Folder

An overview of all existing project folders is shown. Select a folder to store the results of the measurements.

③ Project Folder Name

All measurements are stored in this project folder.

④ Autosave

Setting of auto or manual data file naming and saving

On The results are named and stored automatically in the selected project folder.

Off A question mark appears in the upper menu bar  at the end of the measurement. You can choose to individually name and store each single measurement.

Assisted A pop up menu appears after each measurement. You may select to keep or delete the stored measurement records.

⑤ **Save Test**

Stores the measurement in the selected project folder.

⑥ **Save Screenshot**

Stores the XL2-TA screen in the selected project folder.

⑦ **Load Test**

Loads back previously-stored result data from the SD Card for detailed examination on the instrument screen.

⑧ **Append Mode**

The append mode stores one or more results into the same data file, simplifying data analysis and handling on the PC.

Application example:

When measuring the acoustic spectrum at various locations within the same venue, the append mode allows you to store all the measurement results into one single data file.

⑨ **Free Memory**

Displays the remaining available memory on the SD Card.

The XL2-TA prevents a memory overflow. SD Cards are not designed for a 100% memory usage; the XL2-TA keeps at least 2% or 50 MB empty.

The XL2-TA deactivates the audio recording 50 MB before this limit is reached and reports this on the display.

In the case where only 2% or 50 MB remains, the XL2-TA

- deactivates the data logging and reports this on the display.
- disables Save Test and Autosave
- saves the report at the end of the current measurement.

⑩ Write Cache (available with Extended Acoustic Pack)

A low **Write Cache** level indicates that the SD Card is performing well. The optional Extended Acoustic Pack with simultaneous 100ms logging and linear wav-file recording results in high data volumes being written to the SD Card. Some non-original SD Cards may overload (**OVL**D), causing the loss of some measurement data. Verify the **Write Cache** of your SD Card during your measurements. Use only original SD Cards. We recommend SD Cards from the manufacturers SanDisk and Transcend.



Original SD Cards ensure that all measurement data and audio wav-files are stored in good order on the SD Card. Non-original SD Cards may lead to low performance or errors.
Order information: see chapter Accessories.



In case the SD Card is full, you can insert the original spare SD Card into the XL2-TA and continue with the measurements. The XL2-TA generates the projects and system folders automatically.

Memory Structure of SD Card



① Projects

The folder **Projects** contains subfolders with the stored measurement results. The default subfolder name is "**MyProject**". You can create further individual subfolders.

② XL2.htm

This file opens the XL2-TA instrument status page, with Serial Number, Firmware and Installed Options.

The page also provides links for online

- Firmware updates
- Activation of Options

③ XL2-TA_SYS

The XL2-TA system folder contains a file with serial number, firmware version and installed options - DO NOT EDIT THIS FILE.

Measurement Data - Getting Started

Enable Data Logging

- Select the **Log** page in the sound level meter function and set the logging parameters; e.g., as follows:

SLMeter Log XLR	
Logging	On
Interval dt:	00:00:01.0
Add Spectra:	No
Log Audio:	On
Format:	Compressed+AGC
Log Values:	Selected
0 LAeq	5 ---
1 LAFmax	6 ---
2 LAFmin	7 ---
3 LCPKmax	8 ---
4 ---	9 ---

Select Parameters for Measurement Report

- Select the **Rep** page in the sound level meter function and set the parameters as follows:

SLMeter Rep XLR	
Report Setting	
Add Spectra:	All
Report Values:	Selected
0 LAeq	5 ---
1 LCPKmax	6 ---
2 ---	7 ---
3 ---	8 ---
4 ---	9 ---

👉 The data logging is enabled. The sound pressure level will be logged each second while the measurement is running.

Complete the Measurement

- Press page to return to the numeric result page.
- Press start . The sound level measurement is now running.
- Press stop to complete the sound level measurement.

👉 The measurement data is stored automatically using the factory settings. In the memory menu „Autosave: Assisted” is activated.



Manual Data Saving

- In the case when the instrument is used with the setting **Autosave: Off**, a question mark appears after the completed measurement .
- Now you may store the measurement data manually.
- Select the memory menu with the rotary wheel and confirm with enter .

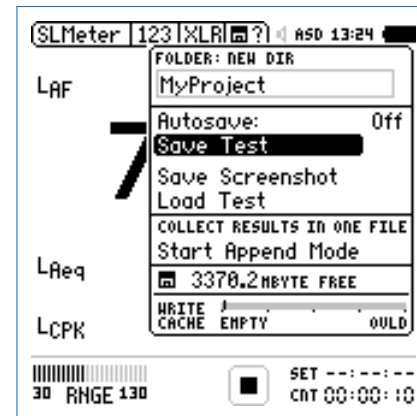

- Press enter to confirm **Save Test**.

👉 The pop-up window **Save Test** appears.

Select File Name



- Name the first part of the file name. The maximum length of the first part is 12 characters. The next part “_SLM_001” is defined by the XL2-TA to avoid overwriting of existing measurements, whereby “SLM” is the appendix for the measurement function and “001” is an automatically-incrementing number.

Predefined Save Names

Generate a text file with user defined save names, such as “Room1”; “Room2”; ..., and store it as “savenames.txt” in the root directory of the XL2-TA. Just use names with letters or numbers - special characters are not supported.

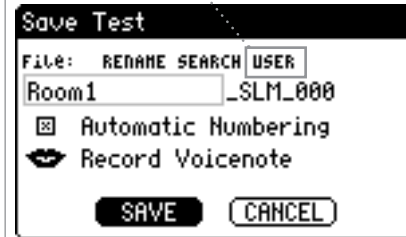
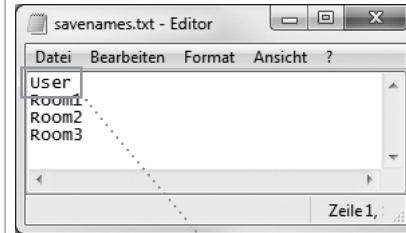

The XL2-TA displays the first line of the txt-file in the **Save Test** selection menu at manual data saving.

Record Voice Notes

With the internal voice note microphone, record a Voicenote to save with the test to remind yourself at a later stage where and/or under which conditions the measurement was done.

- Select **Record Voicenote** and press enter (↵).



- Select **REC** and press enter (↵).
- Record the voice note and press enter (↵) to finish.

👉 The voice note has been recorded.

Save Measurement Data

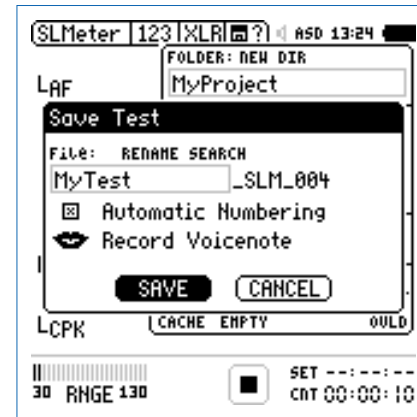

- Select **SAVE** and confirm with enter (↵).

👉 The measurement data including test configurations and all log files are stored on the SD Card.



Overwrite File

Disabling **Automatic Numbering** allows results to be overwritten with new results.

Save Screenshot

- Select the memory menu with the rotary wheel and confirm with enter .

The memory menu opens.

- Select **Save Screenshot** and press enter .
- Select the file name and confirm **SAVE** with enter .

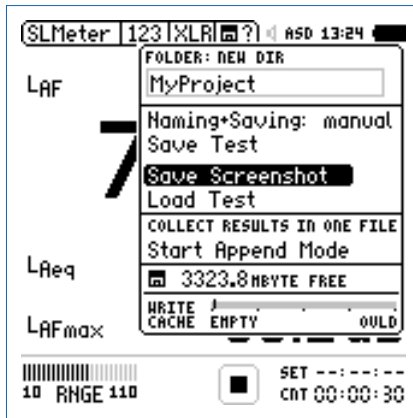

The screenshot is saved to the SD Card.

Measurement Data Logging:

If the battery runs out while you are measuring with logging and/or repeated-reporting enabled, the XL2-TA creates the folder RESTORE_AFTER_POWERFAIL and stores the measurement data up until the switch-off time. The next time you switch on the XL2-TA, the following window informs you that this data exists. Click OK:



There may be invalid data at the end of the file, which you can delete manually to create a valid report.

View Project Folder on the PC

- Connect the XL2-TA with the USB cable to the PC.

☝ The pop-up window **USB Mode** appears.

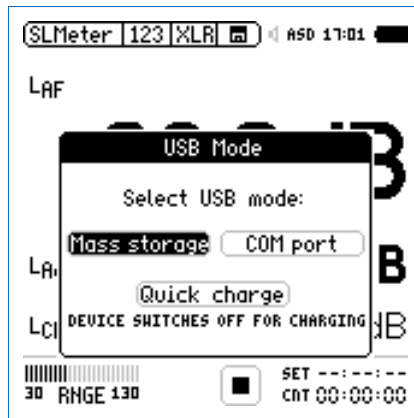

- Select **Mass Storage** and confirm with enter (↵).

☝ The PC recognizes the XL2-TA as a mass storage device. The following SD Card content is shown:



- Open the folder "Projects" and the subfolder "MyProject"

☝ All stored measurement data files are shown.



If the XL2-TA is started with USB connection to PC, then the COM port mode is automatically activated for remote measurement or the XL2 Projector PRO software. Therefore, if you want to access the data in the SD Card, then first start the XL2-TA and thereafter connect the USB cable to the PC.

Overview of Measurement Data Files

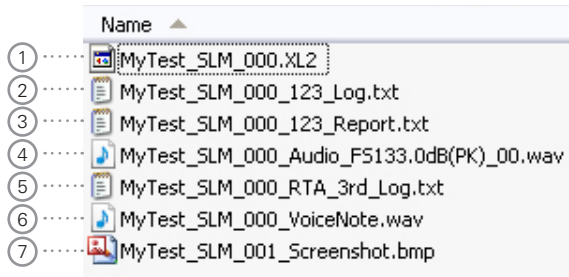

① Test System File

System file for use by XL2-TA only. It contains the measurement data and test configuration of the last measurement cycle for later reload and view of measurement results in the XL2-TA.

② Sound Level Log File

The XL2-TA logs sound levels in pre-defined log time intervals. For more details please see the chapter Sound Level Meter: Logging.

③ Measurement Report File

Final report after the completed measurement. For more details please see the chapter Sound Level Meter: Reporting.

④ Wav-File

The wav-file is the recorded audio file. The index "FS133.0dB(PK)" in file name represents the full-scale peak level of the recorded wav-file. For more details please see the chapter Sound Level Meter: Wav-File Recording.

⑤ RTA Log File

The XL2-TA logs the detailed real-time analyzer spectra in pre-defined time intervals. For more details please see chapter Sound Level Meter: Logging.

⑥ Voice Note

A voice annotation can be recorded for each stored measurement or screenshot. For more details please see the chapter Data Management: Voice Notes.

⑦ Screenshot

Picture of the actual XL2-TA display.



The log data file may become very big during long-term measurement applications. As soon the file size reaches 2 GB during the ongoing measurement, the file is saved with the index 1 and a new data file created with index 2.

XL2 Data Explorer Software combines all these data files together seamlessly.

Transfer Measurement Data to PC

- Drag and drop the required data files to the PC.



Card Reader

Alternatively the SD Card can be inserted into a card reader. This offers a faster data transfer from the SD Card to the PC.

Additional Data Files using Repeat Mode

For sound level measurements with timer mode Repeat or Repeat Synchronized the following additional data files are generated:

- MyTest_SLM_000_123_Report_Rep.txt
- MyTest_SLM_000_RTA_Report_Rep.txt

Common xxx_Report.txt files contain the measurement data of the last measurement cycle. The xxx_Report_Rep.txt file contains the results of all measurement cycles in the Repeat or Repeat Synchronized mode.

Microsoft Excel

The generated .txt files are best viewed on the PC using "Open with" -> Microsoft Excel.

Log File Format

File name: e.g. MyTest_SLM_000_123_Log.txt

```

XL2 Broadband Logging                               MyProjects\MyTest_SLM_000_123_Log.txt
-----
# Hardware Configuration
Device Info:   XL2, SNo. A2A-02673-D1, FW2.20
Mic Type:     NTI Audio M4260, S/N: 1486, User calibrated 2011-04-05 13:56
Mic Sensitivity: 27.3 mV/Pa

# Measurement Setup
Timer mode:   continuous
Timer set:    ---:--
Log-Interval: 00:00:01
k1:          0.0 dB
k2:          0.0 dB
kset Date:   k-Values not measured
Range:       30 - 130 dB

# Time
Start:       2011-05-15, 17:44:06
End:        2011-05-15, 17:44:16

# Broadband LOG Results

```

Date	Time	Timer	LAeq_dt	LAeq	LAFmax_dt	LCPKmax_dt
[YYYY-MM-DD]	[hh:mm:ss]	[hh:mm:ss]	[dB]	[dB]	[dB]	[dB]
15.11.2010	17:44:07	00:00:01	97.0	97.0	102.4	119.0
15.11.2010	17:44:08	00:00:02	85.8	94.3	91.9	105.7
15.11.2010	17:44:09	00:00:03	73.8	92.5	85.2	102.4
15.11.2010	17:44:10	00:00:04	79.0	91.4	85.3	103.9
15.11.2010	17:44:11	00:00:05	72.6	90.4	75.9	94.8
15.11.2010	17:44:12	00:00:06	67.3	89.6	71.4	87.3
15.11.2010	17:44:13	00:00:07	91.2	89.9	95.3	112.3
15.11.2010	17:44:14	00:00:08	92.7	90.4	97.1	113.2
15.11.2010	17:44:15	00:00:09	79.3	89.9	81.6	97.9



Level LAeq_dt "delta t"

Level within the logging interval. e.g. If the logging interval is 1 second, then LAeq_dt is the time-averaged level of each second.

Report File Format

File name: e.g. MyTest_SLM_000_123_Report.txt

```

XL2 Sound Level Meter Broadband Reporting          MyProjects\MyTest_SLM_000_123_Report.txt
-----
# Hardware Configuration
Device Info:   XL2, SNo. A2A-02673-D1, FW2.20
Mic Type:     NTI Audio M4260, S/N: 1486, User calibrated 2010-11-05 13:56
Mic Sensitivity: 27.3 mV/Pa

# Measurement Setup
Append mode:   OFF
Timer mode:   continuous
Timer set:    ---:--
k1:          0.0 dB
k2:          0.0 dB
kset Date:   k-Values not measured
Range:       30 - 130 dB

# Broadband Results

```

Start		Stop		LAeq	LCPKmax
Date	Time	Date	Time		
[YYYY-MM-DD]	[hh:mm:ss]	[YYYY-MM-DD]	[hh:mm:ss]	[dB]	[dB]
15.11.2010	17:44:06	15.11.2010	17:44:16	89.3	119.0

Data Post-Processing

A Microsoft Excel form generating an automated sound level measurement report and chart is available as a free download for all registered XL2-TA customers on the support website at <https://my.nti-audio.com>. (Enable all macros when opening the document.)

XL2 File Validator

A check sum is written to the file at the end of every measurement report. The XL2-TA Analyzer calculates the check sum automatically based on the data content of the file. Using the XL2 File Validator PC-software, the contents of a data file may be verified at any time. e.g. authorities can verify if the XL2-TA report file is original or the data has been manually modified.

The software "XL2 File Validator" is available for download for all registered XL2-TA customers at <https://my.nti-audio.com>.

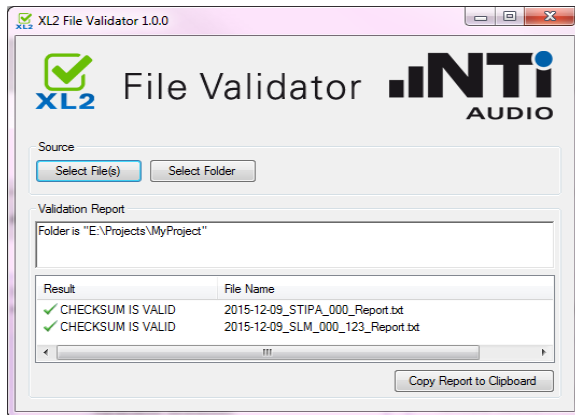

Recall Measurements

The straight-forward but powerful **Load Test** and **Save Test** functions serve the dual purpose of conveniently retrieving standard test setups for repeat testing and also of saving stored result data for later recall and examination on screen.

The following measurement functions support the recall function:

- SLMeter, sound level meter
- FFT Analysis
- RT60 Reverberation time
- 1/12 Octave Band Analysis
- Noise Curves
- STIPA, speech intelligibility measurement

Load Test

- Select the memory menu with the rotary wheel and confirm with enter .

The memory menu opens.

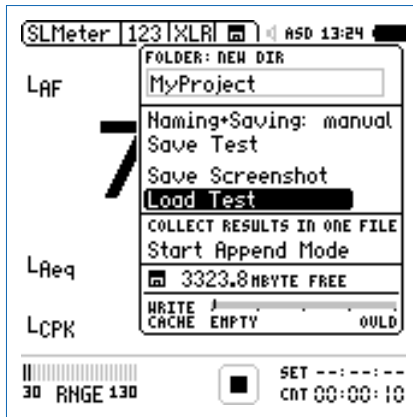

Select File Name

- Select **Load Test** and confirm with enter .

The pop-up window **Load Test** appears.



- Select the project folder and stored data file name with **DIR**.
- Select **LOAD**, confirm with enter .

View Measurement Data

👉 The previously stored measurement data is displayed.

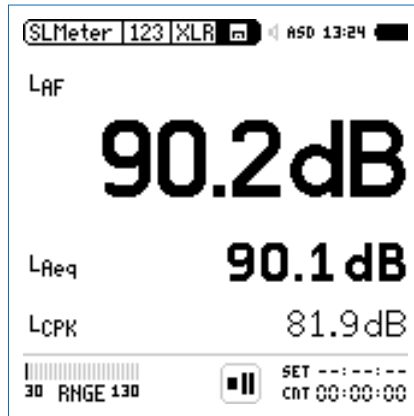

⋮
①



The run indication ① shows the pause symbol. You may continue with the measurements directly, e.g., choose the measurement function, setup parameters and press start .

Append Measurements

The append mode stores the results of several individual measurements into the same data file, thus simplifying measurement result analysis and data handling on the PC.

The following measurement functions support the append mode:

- SLMeter, sound level meter
- STIPA, speech intelligibility measurement

Application example:

The sound level L_{Aeq} shall be measured at various locations in the same venue hall using a pink noise test signal. The append mode allows to store all individual measurement results into one single data file.



Backup the stored measurement data from the XL2-TA to the PC daily. This prevents any data loss if data has been deleted from the SD Card by mistake.

Start the Append Mode

- Select **SLMeter** and preselect the sound level L_{Aeq} .
- Select the memory menu with the rotary wheel and confirm with enter .

The memory menu opens.

- Select **Start Append Mode** and confirm with enter .



The **Start Append Mode** window opens.

Select Filename



- Name the first part of the file name. The maximum length of the first part is 12 characters. The next part “_SLM_001” is defined by the XL2-TA to avoid overwriting of existing measurements, whereby “SLM” is the appendix for the measurement function and “001” is an automatically-incrementing number.
- Select **START** and confirm with enter .

The append mode is available.

Take Measurement Results

- Measure the sound level L_{Aeq} on the first position.
- Select the memory menu and **Append Data**.





In append mode, the XL2-TA does not store:

- Log files
- Wav-files
- Repeated report files generated in timer mode **repeat** and **repeat synchronized**.

Store Measurement Results

👉 The pop-up window **Append Data** appears.

- Select the location ID and measurement ID, thus each measurement result is stored with an individual description for later documentation.
- Select **Append** with the rotary wheel  and confirm with enter .

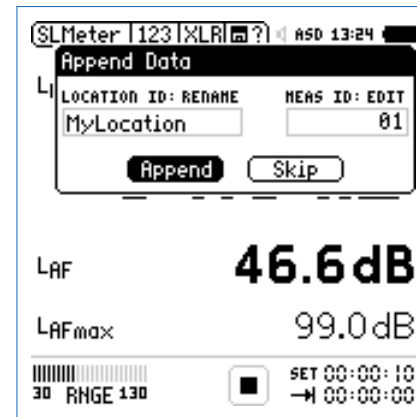

👉 The measurement data is stored on the SD Card.

Append Further Measurement Results

- Move to the next location in the room, carry out the measurement and follow the described append data procedure.

Exit Append Mode

- Open the memory menu .
- Select **Exit Append** after adding the last measurement.



Auto Append

Alternatively the XL2-TA can append measurement data to the same report file automatically.

- Start the Append mode and set **Auto Append is ON** in the memory menu or in the pop-up window **Start Append Mode**.

Skip Append Data

If you select **SKIP** in the **Append Data** window, then no measurement data is appended to the report file.

Append After Power Up

You can continue to add measurement results into the same data file at any time later.

- Store the measurements in the append mode and switch the XL2-TA off and on again .

 The pop-up window **Continue append** appears.

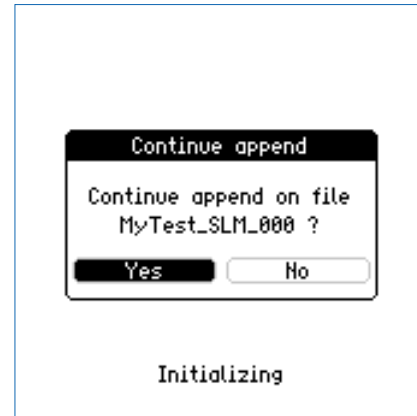

- Select **Yes** and continue adding measurement results to the same report file in the append mode.

Recall Previous Measurements for Append

Any previously stored measurement with the remark **for append** can be recalled and further test records appended.

- Select **Load Test** and press enter (↵).
- Select the project folder and stored data file name.
- Select **LOAD** confirm with enter (↵).

👉 The pop-up window **Load for Append** appears.



- Select **Continue** and add further measurements to the same report file in the append mode.

13. XL2 Projector PRO Software

The Projector PRO displays the XL2-TA screen in real-time via USB on the connected Windows or Mac computer. The software toolbar enables control of the XL2-TA with the mouse and keyboard. The background color turns from green to red synchronized with the XL2-TA limit button color  according to the user-defined limits.

The “XL View” and the “Sound Level Predictor” display extend the XL2 Projector PRO for live sound monitoring applications.

- The “XL View” window presents sound levels in large size on the connected computer screen. Users may select to view one, two or three sound pressure levels. Exceeding levels are presented with a pre-warning amber or alarming red color.
- The “Sound Level Predictor” visualizes the level history of the current measurement interval and indicates the headroom for the actual measurement period or the next few minutes. Green bars confirm that the present level is well below limits. Red bars are a call to action to reduce the sound level at the mixing desk. This allows the FOH engineer to optimize dynamic passages of the band for maximum audience satisfaction while still remaining within the legal limits.

Additionally, the Projector PRO software offers the ability to retrieve measurement data from the XL2-TA without interruption to the measurement process. The entire file system of the XL2-TA is available while the XL2-TA is measuring.

The “XL View” and the “Sound Level Predictor” require that the Projector PRO Option or the Remote Measurement Option be installed on the XL2-TA.

Projector PRO software is a free download for all registered XL2-TA customers on the support website <https://my.nti-audio.com>.

Installation Instructions

- Register your XL2-TA and download the software from the support page at <https://my.nti-audio.com>.
- Unzip the file “XL2 Projector PRO Setup Vxx.zip” on your computer.
- Start the software installation and follow the instructions including driver installation.
- Start the XL2 Projector PRO software.
- Start the XL2-TA Analyzer and connect it to the computer.

👉 The pop-up window **USB Mode** appears.

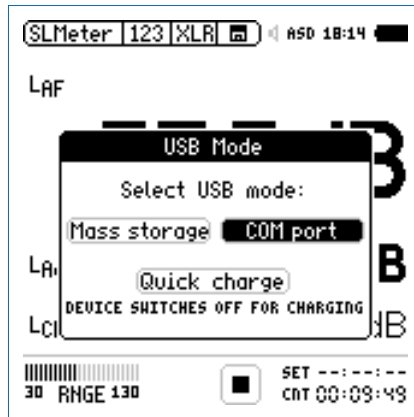

- Select **COM port** on the XL2-TA.
- Microsoft Windows may recognize the new hardware automatically and start the hardware installation assistant. If prompted, select “No connection to Windows Update” and continue with the installation.
- Complete the installation.

👉 XL2 Projector PRO displays the instrument screen in real-time.

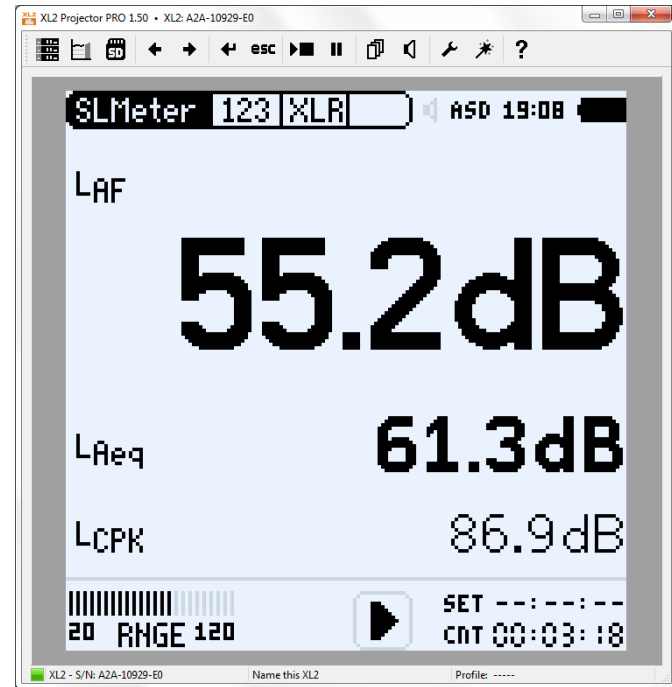

For more details and features see the XL2 Projector PRO user manual at ? in the menu.

14. Data Explorer (optional)

Data Explorer is a PC-based software application with a powerful data processor for easy and fast analysis of sound level measurement data. It is dedicated to acoustic consultants and noise measurement professionals. Data Explorer provides a convenient way to view, analyze and manage data and quickly create customized reports.

Features of the Data Explorer software:

- Data visualization
- Fast zoom and pan
- Audio playback synchronized to graph
- Markers with on-the-fly calculations
- Automated tonal and impulsive marker generation
- Percentile levels Ln and Rating level Lr calculation
- Customized Reporting

Download the Data Explorer software from the XL2 Support Page <https://my.nti-audio.com>.

XL2 Data Explorer Permanent

The Data Explorer Permanent license enables the import of logged sound level data into the Data Explorer software, a PC-based software application with a powerful data processor for easy and fast analysis of noise monitoring data.

Data Explorer 365

An annual subscription service for a XL2-TA Sound Level Meter is offered alternatively to the permanently installed license.

Supported operating systems

- Windows XP SP3
- Windows Vista SP1 or later
- Windows 7, 8, 10, 11

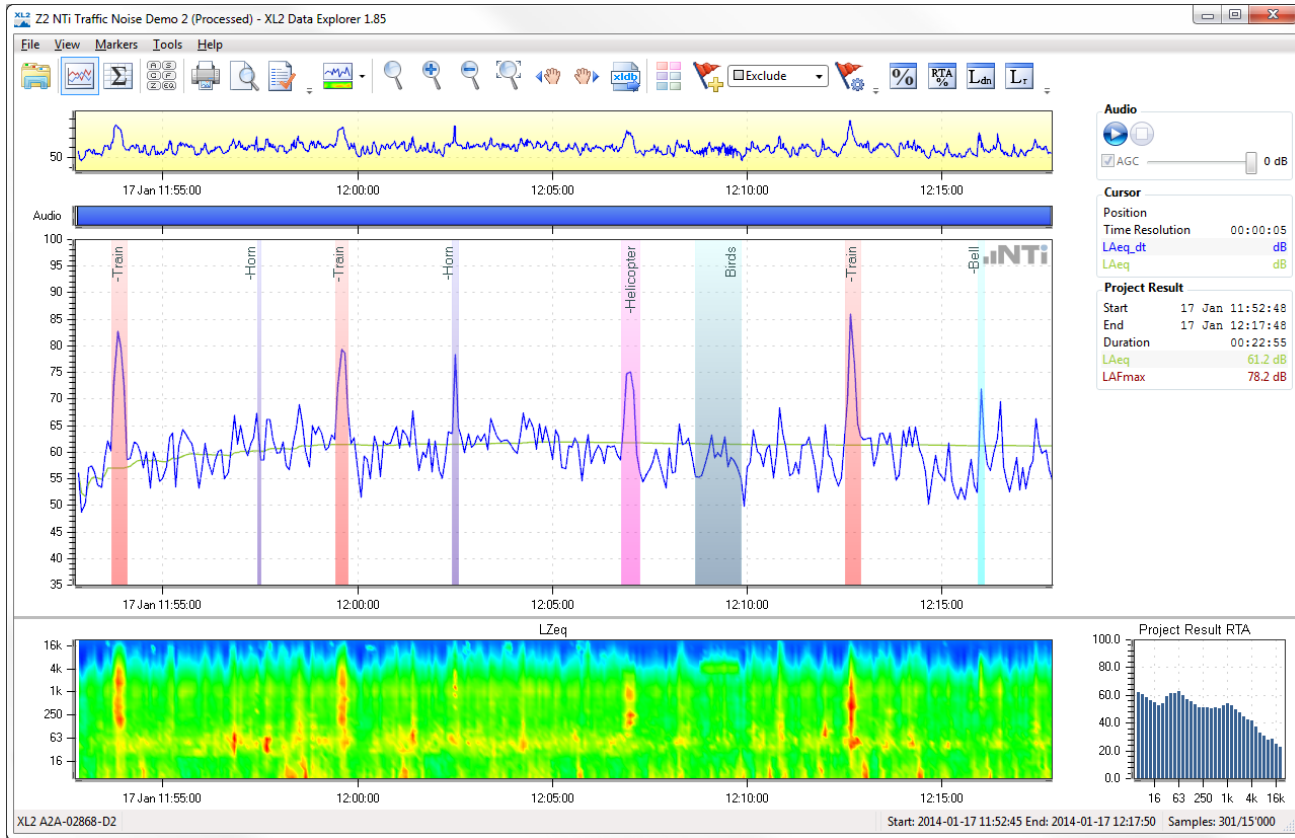

15. Building Acoustics (optional)

The Sound Insulation Reporter software is a PC-based software application that provides all the standard reports for Airborne and Impact sound insulation measurements. Designed for acoustic consultants, this comprehensive tool uses data gathered by the XL2-TA Sound Level Meter, and quickly returns graphical analysis of all measurement positions.

Additionally, the software offers the ability to acquire real-time data; two or more XL2-TA Sound Level Meters, may be controlled directly by the software. This allows simultaneous wireless measurement in both the sending and receiving room onsite; saving time. To enable this real-time acquisition of data, the Sound Insulation Reporter software requires that the connected XL2-TAs also have an activated Remote Measurement Option installed.

Features:

- Airborne, Impact and Facade Sound Insulation
- Customized Reporting
- Standards ASTM E336, ASTM E413, ASTM E1007, ASTM E989, ASTM E966, ASTM E1332, BB93, DIN 4109, Document E, GB/T 19889, ISO 16283, ISO 140, ISO 717, ISO 10140, NEN 5077:2019, SIA 181:2006, SIA 181:2020

XL2 Sound Insulation Permanent

The Sound Insulation Permanent license enables the import of measurement data into the Sound Insulation Reporter software.

Sound Insulation Reporter 365

An annual subscription service for a XL2-TA Sound Level Meter is offered alternatively to the permanently installed license.

Supported operating systems

- Windows Vista SP1 or later
- Windows 7, 8.x, 10, 11

Requirements

The measurement of the reverberation time in 1/3 octave band resolution requires the optional Extended Acoustic Pack installed on the XL2-TA Sound Level Meter.

Download the software from the XL2 Support Page at <https://my.nti-audio.com>.

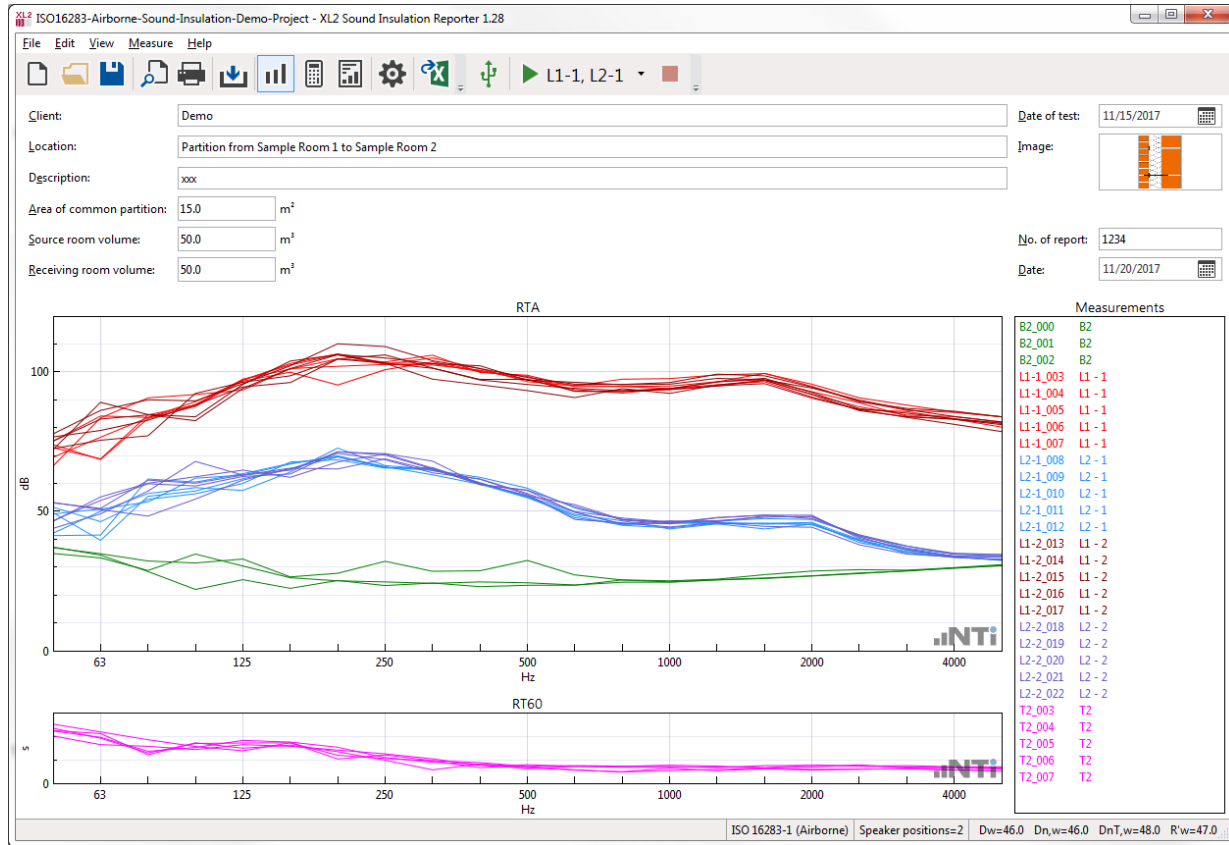

16. Room Acoustics (optional)

The Room Acoustics Reporter is a PC software for automatically generating reverberation time measurement reports and analyzing the RTA frequency response spectrum. The software supports acousticians and experts in the visualization and detailed evaluation of measurement data recorded with the XL2-TA Sound Level Meter.

Features:

- Room acoustic simulation according to Sabine or Eyring
- Import of own sound absorber database and tolerances
- Frequency response spectrum and Noise Curves

The following standards are supported

- IEC 61260: Octave-band and fractional-octave-band filters
- GB 50371 - Code for sound reinforcement system design
- ANSI/ASA S12.2-2019 - Noise criteria curves NC
- ANSI/ASA S12.2-2019 - Room noise criterion RNC
- DIN 15996:2020 - Grenzkurven GK
- ISO R 1996-1971 - Noise rating curves NR
- ASR A3.7:2021 - Working Place
- DIN 18041: 2016 - Acoustic quality in rooms
- ISO 3382-1:2009 - Reverberation time in performance spaces
- ISO 3382-2:2008 - Reverberation time in ordinary rooms
- ÖNORM B 8115-3:2015 - Room Acoustics

- ASTM C423-17 - Sound Absorption
- ISO 354:2003 - Sound absorption in a reverberation room

XL2 Room Acoustics Permanent

The Room Acoustics Permanent license enables the import of measurement data into the Room Acoustics Reporter software.

Room Acoustics Reporter 365

An annual subscription service for a XL2-TA Sound Level Meter is offered alternatively to the permanently installed license.

Supported operating systems

- Windows Vista SP1 or later
- Windows 7, 8.x, 10, 11

Requirements

The measurement of the reverberation time in 1/3 octave band resolution requires the optional Extended Acoustic Pack installed on the XL2-TA Sound Level Meter.

Download the software from the XL2 Support Page at <https://my.nti-audio.com>.

Office - XL2 Room Acoustics Reporter 1.0

File Edit View Help

Client: Sample Inc Date of test: 15/02/2019

Object: Office with wooden floor Image:

Description: empty room w/o furniture

Room Volume: 50.00 m³ Room Surface: 70.00 m² No. of report: 1234

Date: 22/05/2019

Freq f [Hz]	T1 RT60 [s]	Pred RT60 [s]
100	2.81	1.20
125	2.86	1.18
160	2.34	0.86
200	2.04	0.78
250	2.01	0.75
315	2.03	0.72
400	1.89	0.59
500	1.81	0.55
630	1.65	0.55
800	1.39	0.48
1000	1.21	0.49
1250	1.07	0.44
1600	0.87	0.43
2000	0.85	0.45
2500	0.79	0.41
3150	0.69	0.38
4000	0.69	0.43
5000	0.68	0.49

Reverberation Time RT60

Legend: T1, Predicted, Tolerance

Speech at Room Volume 50 m³

Materials

Ceiling [m²]

- 0.00 Phon Base 40mm
- 12.00 Phon Base 40mm, susp200

Mid

400 - 1250	1.50	0.52
------------	------	------

ISO 3382-2

17. Sound Power (optional)

Sound Power Reporter is a PC-based software application that provides all the standard reports for sound power measurements in accordance with ISO 3744 and ANSI-ASA S12.54.

Designed for industrial professionals, this comprehensive tool uses data gathered by the XL2-TA Sound Level Meter, and quickly returns graphical analysis of all measurement positions.

Features of the Sound Power Reporter software:

- Visualization of all measurement
- Customized Reporting
- Standards ISO 3741, ISO 3744, ISO 3746, ANSI-ASA S12.51, ANSI-ASA S12.54, ANSI-ASA S12.56

Download the software from the XL2 Support Page at <https://my.nti-audio.com>.

XL2 Sound Power Permanent

The Sound Power Permanent license enables the import of measurement data into the Sound Power Reporter software.

Sound Power Reporter 365

An annual subscription service for a XL2-TA Sound Level Meter is offered alternatively to the permanently installed license.

Supported operating systems

- Windows Vista SP1 or later
- Windows 7, 8.x, 10, 11

Requirements

The measurement of the reverberation time in one-third octave band resolution requires the optional Extended Acoustic Pack installed on the XL2-TA Sound Level Meter.

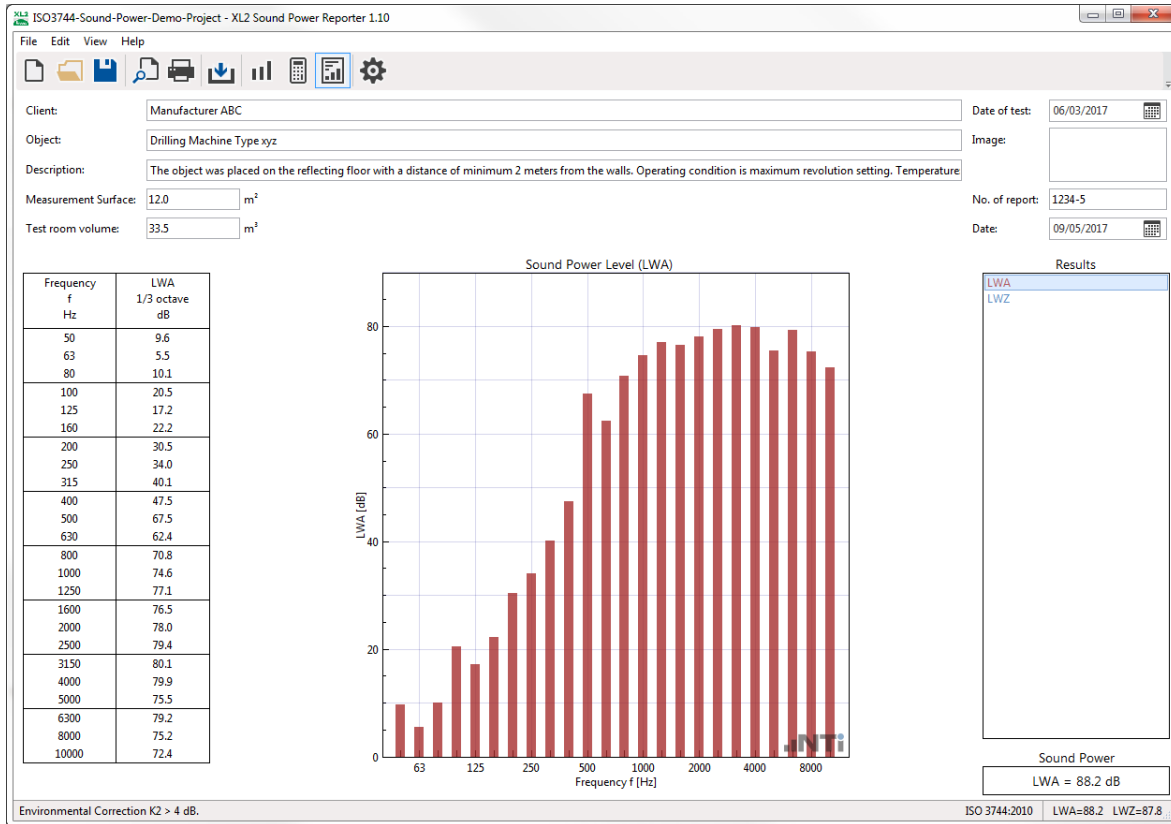

18. Unattended Noise Monitoring

NoiseScout provides a comprehensive but easy-to-use 24/7 noise monitoring solution. Noise levels are recorded on-site by the XL2-TA Sound Level Meter and are available for remote monitoring and download. NoiseScout is aimed at both short-term noise assessments and long-term monitoring applications. It offers the freedom to start and stop the remote noise monitoring from your office or mobile device providing total flexibility in meeting your project requirements.

Noise Monitoring in “Managed Mode”

During acquisition, audio recordings of the loudest periods and automated email alerts allow noise issues to be addressed before a non-compliance condition arises. NoiseScout displays the noise levels measured by the XL2-TA Sound Level Meter live in your web browser. The measurement data recorded out in the field is presented online in charts and dashboards. Multiple noise level meters can be monitored simultaneously within the map view, thus providing localized geographic visualization for all noise levels at a glance. Identified users can access all their projects, control their monitors or create basic view modes, allowing stakeholders to oversee their noise level data.

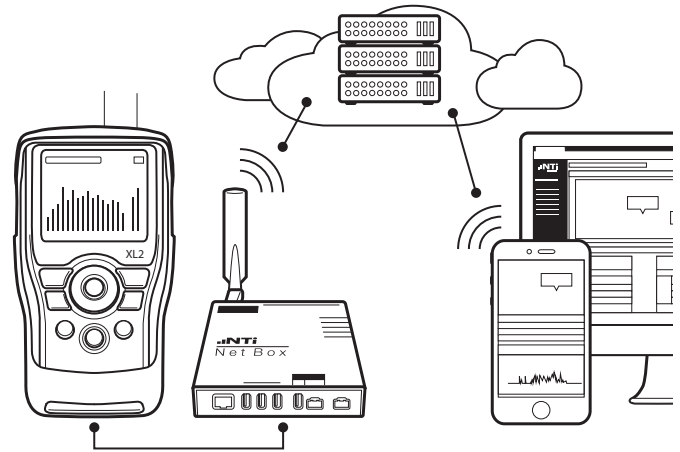

Managed Unattended Noise Monitoring

Noise Monitoring in “Gateway Mode”

Direct access to the XL2-TA Sound Level Meter is available from around the world. An internet connection allows SFTP (Secure File Transfer Protocol) and remote access to the XL2-TA. All data files can then be retrieved from the remote XL2-TA Sound Level Meter even during an ongoing measurement. Also, the spectral data and audio files can be directly downloaded from the remote XL2-TA.

The remote access allows full control of the XL2-TA Sound Level Meter. All remote measurement commands available on the XL2-TA are supported. For example, the current measurement data may be captured in real time into a computer application, e.g. C#, MS Excel or LabView. You may program a customized measurement application for remote sound level monitoring, audio analysis or automated measurement tasks.

NoiseScout operates also in a local network (intranet) without internet connection.

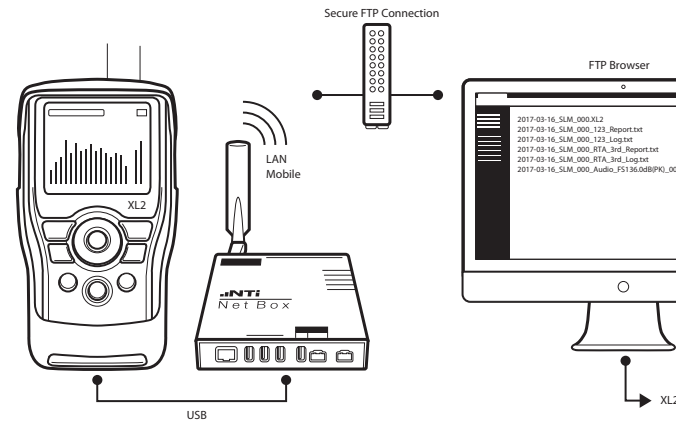

Remote Access to XL2-TA Sound Level Meter

How to connect?

The NetBox may be connected to the internet via mobile (3G, 4G, 5G; 4G/5G using an external modem), LAN or Wi-Fi.

The LAN connection is established automatically. Setup on the XL2-TA is required for the 3G mobile and Wi-Fi connection.

- Insert SIM card (not provided) into the NetBox
- Connect the NetBox to the XL2-TA Sound Level Meter.
- Select ① and confirm with enter ↵.



① Network Status Indication

It replaces the speaker symbol in the top menu.

- ⊠ No network connection
- 📶 Network connection established
- ✓ Confirmation check mark indicates successful on-going NoiseScout communication



- Select **Settings** (2) and confirm with enter (↵).
- Select **Mobile Data** and confirm with enter (↵); the minimum requirement is entering the APN of your provider.

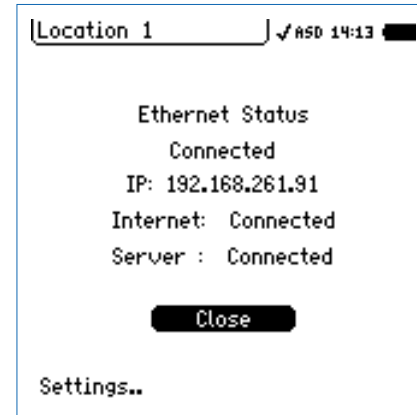

- Confirm **Close**.

👍 The XL2-TA is connected to the network.

- Set the connection parameters and select **Exit**.

Automated System Self-Test

The measurement microphone of a noise monitor is permanently exposed to the weather. This might impair the microphone capsule and its performance. Therefore, NoiseScout offers an automated system self-test (CIC). The complete signal chain may be verified periodically, remotely, and without removing the microphone from site. Thus, precise sound level measurements are ensured. This test also produces an alarm in case of any unexpected issues, like cable or microphone defects.

The automated system self-test is supported by the XL2-TA Sound Level Meter with the M2340 Measurement Microphone. The microphone preamplifier has a built-in dedicated signal generator for the self-test, which is activated from NoiseScout via the XL2-TA Sound Level Meter through the ASD communication. This generator produces a square wave signal with the fundamental frequencies 31.25 Hz and 1000 Hz and the corresponding harmonics for the self-test. The generated test signal spectrum is measured by the XL2-TA and stored as a reference. Later on, NoiseScout repeats the same test, e.g. daily, and the resulting one-third octave spectrum is compared against the reference.

One-Third Frequency Band [Hz]	Description	Typical reference spectrum [dB]
31.5	fundamental square wave	102.4
100		92.4
160		87.9
200	harmonic	84.3
315		83.1
400		80.4
500	harmonic	80.8
630		79.3
800		78.5
1000	fundamental square wave	101.7
3150		92.3
5000		88.1
6300	harmonic	84.0
8000		82.6
10000		84.2
12500	harmonics	81.6
16000		81.7
20000		80.1

The maximum deviation in each frequency band is specified at 1 dB supporting the specified range of environmental conditions. Unexpected issues, like cable defects, loose capsule mounting, or a missing microphone capsule cause a higher deviation and trigger an automated alarm.

High ambient noise may affect the self-test. Therefore, the ambient noise level is measured prior to performing the self-test. All is fine as long as the ambient noise effect is less than 0.2 dB during the self-test – this requires the ambient noise to be 13.3 dB below the reference spectrum of the self-test. High ambient noise levels will be reported in combination with a failed self-test.

The following workflow is carried out by NoiseScout

- Measure ambient noise level and compare result with reference spectrum
- Generate 31.25 Hz square wave signal and measure actual noise spectrum
- Generate 1000 Hz square wave signal and measure actual noise spectrum
- Compare results with the reference one-third octave spectrum

This workflow takes approximately 7 seconds.



Self-Test Method

The system self-test uses the charge injection check method, in short CIC. A dedicated square wave signal is capacitively coupled to the input of the MA230 PreAmplifier and attenuated by the capacitance of the microphone capsule.

Physical changes in capsules can influence their capacitance, which ultimately leads to a changed level read from the test signal. The test signal passes through the preamplifier and the cable to the XL2-TA Sound Level Meter for evaluation. This allows any changes in the microphone capacitance, e.g. caused by damages of the microphone capsule or a loose capsule mounting to be detected.

Additional periodic manual calibration using a Sound Calibrator is recommended in combination with a visual inspection of the noise monitor.

19. Time Synchronization

Not relevant for XL2-TA Analyzer.

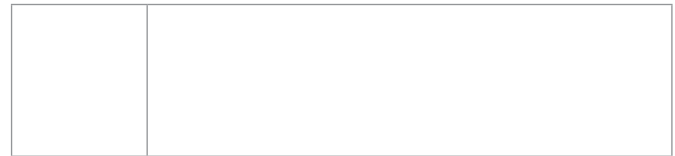

20. Remote Measurement

The Remote Measurement option allows the real-time acquisition of XL2-TA measurement data directly into a computer application via USB. The option adds a real-time acquisition facility to the Sound Insulation Reporter software.

Alternatively you can write your own unique measurement applications for sound level monitoring or automated measurements, e.g. with MS Excel or LabView. A documented command set for data retrieval via USB is available. The following XL2-TA measurement functions are supported:

- Sound level meter and spectrum analyzer SLMeter/RTA
- Vibration Meter VibMeter
- FFT Analyzer + Tol
- RT60 reverberation time
- Audio analyzer RMS/THD+N
- High-resolution RTA function 1/12 Oct + Tol

The functionality of the Projector PRO option is included.

Order information:
Remote Measurement Option
NTi Audio #: 600 000 375

The commands are sent in ASCII format through the virtual COM port to the XL2-TA Analyzer.

Example Command Set

```
INIT START
MEAS:INIT
MEAS:SLM:123? LAF
Result returned to PC: 53.8 dB,OK
```

The time the XL2-TA requires for a response depends on the command and the workload of the XL2-TA (logging settings). A typical pattern for querying measurement data is:

```
XL2.write(«MEAS:INIT\n»)
XL2.write(«MEAS:SLM:RTA:dt? EQ\n»)
result = XL2.readline()
```

This pattern delivers a measurement result within:

- Min: 8 ms
- Mean: 10 ms
- Max: 35 ms

For more details you may download the dedicated Remote Measurement Reference Manual.

Auto Start

The XL2-TA with serial number ending “E0” or higher may power on automatically upon after a power loss (e.g. mains power disconnected or battery pack empty) the power is available again. Best the instrument is operated by mains power without the internal battery pack installed. This auto start functionality is enabled by copying a txt-file with the file name “AutoOn.txt” onto the SD Card. This allows to remotely control the XL2-TA as soon as power supply is available at the instrument.

21. Microphones

Overview Measurement Microphones

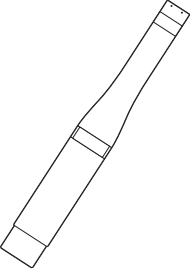
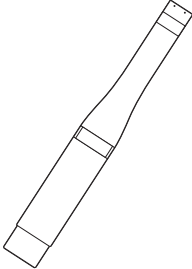
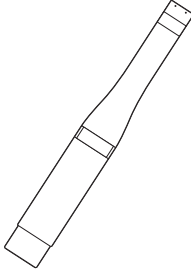
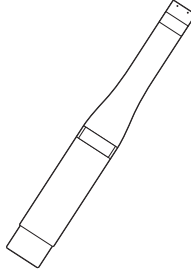
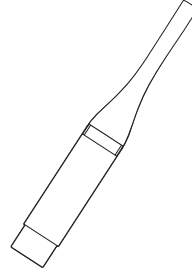
M2230	M2340	M2211	M2215	M4261
				
Certified Class 1 measurement microphone in accordance with IEC 61672, metal diaphragm	Certified Class 1 measurement microphone in accordance with IEC 61672, metal diaphragm, system self-test (CIC) with XL2-TA	General purpose measurement microphone class 1 frequency response, metal diaphragm	Measurement microphone for high sound levels (up to 153 dB), class 1 frequency response, metal diaphragm	Cost-effective class 2 measurement microphone for general sound level testing and service of audio-acoustic installations
consists of MA220 PreAmplifier and MC230 or MC230A capsule	consists of MA230 PreAmplifier and MC230A capsule	consists of MA220 PreAmplifier and 7052 capsule	consists of MA220 PreAmplifier and 7056 capsule	with permanently-installed capsule

Overview Outdoor Measurement Microphones

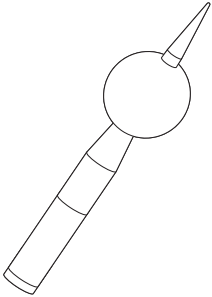
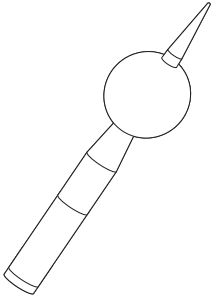
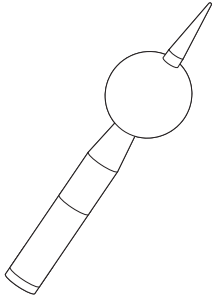
M2230-WP Outdoor Microphone	M2340-WP Outdoor Microphone	M4261-WP Outdoor Microphone
		
<p>Certified outdoor measurement microphone, class 1 in accordance with IEC 61672</p>	<p>Certified outdoor measurement microphone, class 1 in accordance with IEC 61672, system self-test (CIC) with XL2-TA</p>	<p>Outdoor measurement microphone, class 2 in accordance with IEC 61672</p>
<p>consists of M2230 Measurement Microphone + WP30 Weather Protection</p>	<p>consists of M2340 Measurement Microphone + WP30 Weather Protection</p>	<p>consists of M4261 Measurement Microphone + WP61 Weather Protection</p>

Overview Microphone Preamplifier

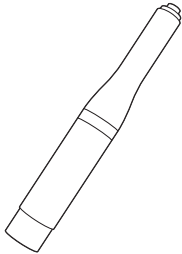
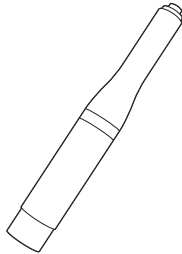
MA220 PreAmplifier	MA230 PreAmplifier
	
<p>Microphone preamplifier compatible with 1/2" pre-polarized capsules</p>	<p>Microphone preamplifier compatible with 1/2" pre-polarized capsules, system self-test (CIC) with XL2-TA</p>

The plug-on measurement microphones combined with the XL2-TA Analyzer create a powerful sound level meter and a professional acoustic analyzer. The microphones are 48 VDC phantom-powered and include an electronic data sheet.

Integrated Preampfier

The microphone body contains a preamplifier that requires 48VDC phantom power supply for operation. The microphones combine high dynamic range and wide frequency range with low noise. They can also be connected to the XL2-TA Audio and Acoustic Analyzer using an ASD Cable for measurements at remote locations or for reduction of acoustic reflections.

Electronic Data Sheet

The microphones include an electronic data sheet. The Automated Sensor Detection (ASD) of the XL2-TA Analyzer reads this data, i.e. the microphone model and calibration data. This promotes faster setup and ensures accurate measurements.

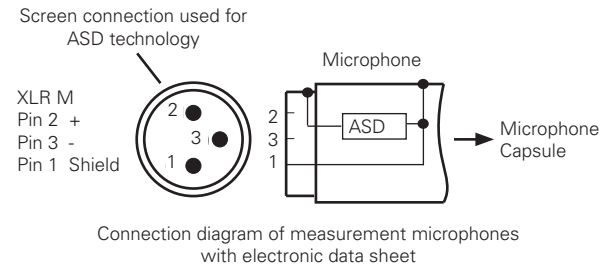

Microphone plugs directly into the XL2-TA

The XL2-TA automatically reads the electronic data sheet of the connected microphone as follows:

- Connect the measurement microphone to the XL2-TA.
- Switch on the XL2-TA.

👉 The XL2-TA reads the electronic data sheet of the connected microphone during a brief initialization process prior to the first measurement.

Microphone Connection via the ASD Cable

The NTi Audio measurement microphones can be connected to the XL2-TA Analyzer using an ASD Cable for measurements at remote locations or for reducing acoustic reflections. The electronic data sheet is transmitted via the XLR connector's housing. Do not touch this during the brief initialization period to ensure the complete data sheet is recognized by the XL2-TA. The automated sensor detection does not disturb any measurements. You may join 5 or 10 meter ASD Cables together in series. The ASD technology supports accurate data communication up to a combined cable length of 20 meters (= 65 feet).

Microphone Connection via a professional Audio Cable

For distances longer than 20 meter (= 65 feet) use a high-quality, low-capacitance standard professional audio cable. The microphone sensitivity has to be entered manually into the XL2-TA Analyzer.

Alternatively connect the microphone first directly to the Analyzer. The XL2-TA reads the sensitivity and remembers this value. Afterwards connect the audio cable.



- Use the microphone for the intended purpose only.
- Protect the microphone from contamination by always using the supplied windscreen.
- Never use the microphone in a damp or wet environment.
- Do not jar or drop the microphone.
- Do not remove the microphone protective grid.
- Do not touch the microphone membrane.
- Remove the black dust cap of the 1/2" measurement microphones prior to use.
- In an outdoor environment, ensure that you install protection against lightning strikes.

Outdoor Measurement Microphones

The Outdoor Measurement Microphones offer a weather-protected measurement solution for the XL2-TA Sound Level Meter allowing acquisition of environmental noise data in outdoor applications. The corrosion-free polymer housing, wind screen, water-repellent membrane and bird spike provide excellent protection from rain, wind, dust and perching birds.

Outdoor Measurement Microphone Types

- M2230-WP: M2230 Measurement Microphone + WP30 Weather Protection
- M2340-WP: M2340 + WP30 Weather Protection
- M4261-WP: M4261 + WP61 Weather Protection



- Do not install the Outdoor Measurement Microphones in horizontal direction. Raindrops may damage the measurement microphone.
- The snap mechanism works only at temperatures above -15°C / 5°F (as the O-Ring stiffens). In colder conditions we suggest you warm up the housing first, e.g. with your hands.

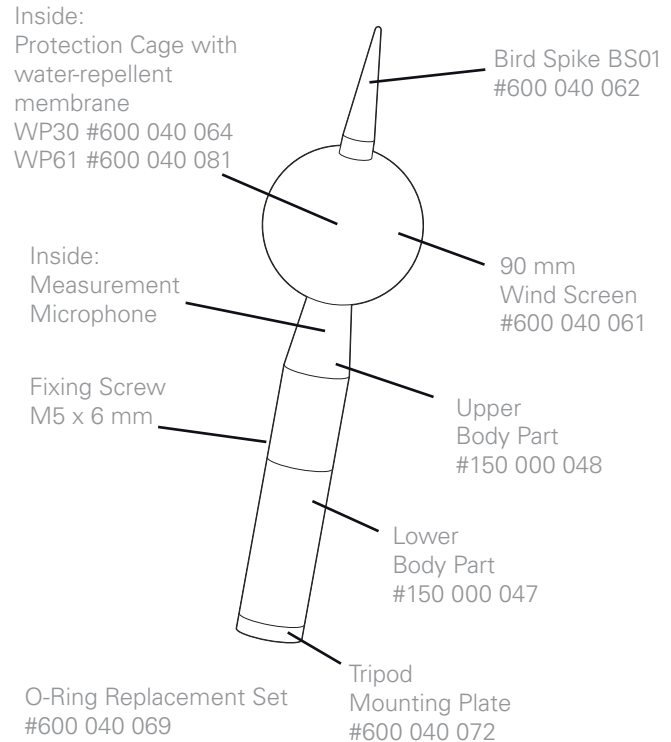

The Outdoor Measurement Microphones M2230-WP and M2340-WP fulfill the Class 1 requirements according to IEC 61672 and ANSI S1.4 for vertical sound incidence. For compliance with horizontal sound incidence, a spectral correction is employed in the associated XL2-TA Sound Level Meter.

Alternatively, the Measurement Microphone M2211 or M2215 can be fitted into the Weather Protection WP30. These microphones have to be pushed further into the upper body by 3 mm. The top part of the capsule has to be 13 mm above the upper body housing of the WP30. This is required because the M2211 and M2215 capsule is 3 mm shorter than the default M2230 microphone capsule.

The Outdoor Measurement Microphone M4261-WP fulfills the Class 2 requirements according to IEC 61672 and ANSI S1.4. It consists of an M4261 Microphone and the WP61 Weather Protection. For compliance with horizontal sound incidence a spectral correction is employed in the associated XL2-TA Sound Level Meter.



Always activate the applicable frequency correction filter in the XL2-TA. The filter ensures that the measurements accuracy meets the class 1 requirements of IEC 61672 and ANSI S1.4.

Assembling

This chapter describes how to install the Measurement Microphone into the weather protection kit:

Install ASD Cable

- Feed the female XLR of the ASD Cable through the bottom of the lower body tube.
- Attach the footer plate to the lower body tube using the three allen screws, feeding the cable through the side slot of the footer plate.

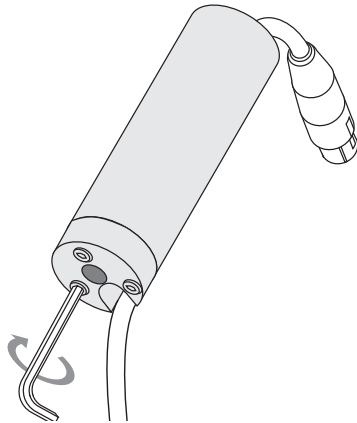

Insert Measurement Microphone

- Connect the measurement microphone to the female XLR of the ASD Cable.
- Insert the measurement microphone into the upper body tube so that the bottom end of the microphone is in line with the bottom end of the upper body tube. Align the fixing screw hole of the upper body tube with the lower screw of the measurement microphone (remove the fixing screw to see the lower screw head through the fixing screw hole).

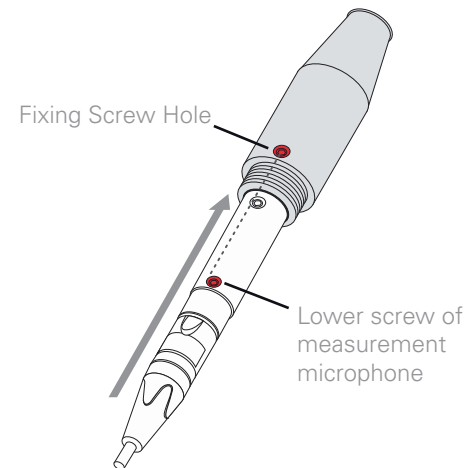

Attach the Microphone to the Upper Body Tube

Attaching the fixing screw of the upper body tube onto the lower screw of the measurement microphone ensures that the microphone housing is not scratched.

- Insert and gently tighten the fixing screw while jiggling the microphone. You will feel the fixing screw center in the head of the lower screw of the microphone. Do not over tighten the fixing screw.
- Again verify that the bottom end of the inserted microphone is in line with the bottom end of the upper body tube.

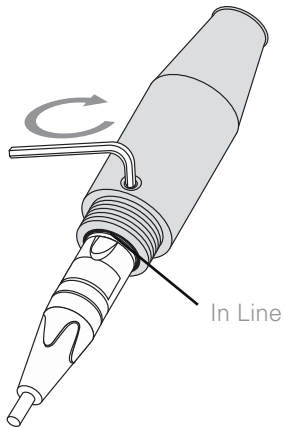

Assemble the Weather Protection Body

Retract the ASD cable through the lower body tube and screw the lower body tube to the upper tube, ensuring that the cable does not twist during this operation.

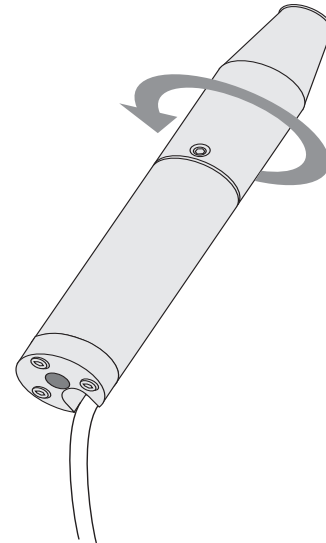

Mount the Top Section

The top section of the weather protection kit consists of the wind screen, the enclosed protection cage with water-repellent membrane and the bird spike. Gently slide the top section over the microphone tip and on to the upper body tube. You will feel a slight increase in resistance approximately 3 mm before the top section's final position. Slightly increase the pressure until the top section snaps into the final position with an audible click.

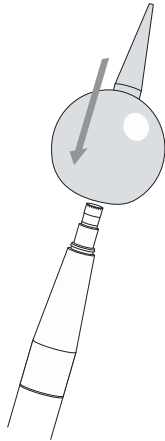

👍 You have successfully assembled the Outdoor Measurement Microphone.

Calibration

The design of the Outdoor Measurement Microphone supports easy calibration of the microphone. To calibrate, follow the procedure below:

- The top section of the Outdoor Microphone is snapped on to the body tube. Remove the top section of the Outdoor Microphone by gently pulling the bird spike upwards. At the same time gently push up on the cage inside the wind screen with two fingers of your other hand. You will feel when the snap mechanism is released. Gently remove the top section.

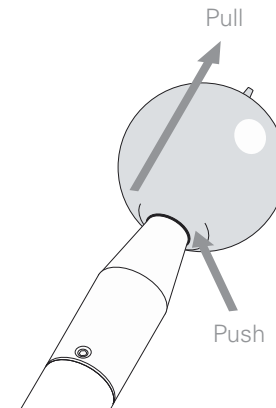

- Calibrate the microphone as described in the XL2-TA user manual using the NTi Audio Precision Calibrator.

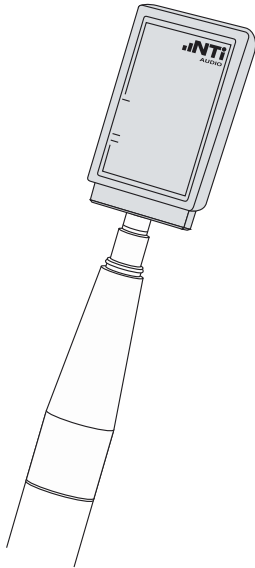

- Snap the top section back into position on the body tube.

 You have successfully calibrated the Outdoor Measurement Microphone.



- The outdoor windscreen is recommended to be replaced annually. The “WP30/WP61 Windscreen Replacement” includes two spare windscreens, NTi Audio # 600 040 061.
- The water-repellent membrane in the top section is mounted with two O-Rings. Inspect these O-Rings (13x1 mm) and the membrane annually for proper seating and good condition. Do not touch the water-repellent membrane.

Disassembling the Top Section

- The top section is snapped on to the body tube. Remove the top section by gently pulling the bird spike upwards. At the same time gently push up on the cage inside the wind screen with two fingers of your other hand. You will feel when the snap mechanism is released.
- Gently remove the top section and turn the top section upside down and hold it by the bird spike.
- Gently unscrew the cage from the hole of the wind screen. Do not touch the water-repellent membrane!
- Assemble in reverse order.

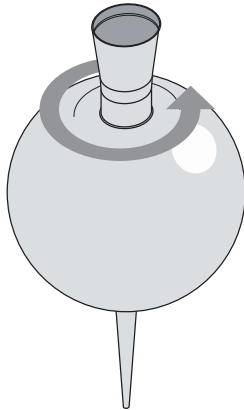

Capsule Replacement Instruction

The microphones for the XL2-TA Analyzer include an electronic data sheet. The Automated Sensor Detection (ASD) of the XL2-TA Analyzer automatically reads this data, i.e. the microphone model and calibration data. This promotes faster setup and ensures accurate measurements. In case of a capsule replacement, the electronic data sheet needs to be updated with the data of the new capsule.

Step-by-Step-Instruction

- Install the new capsule on the microphone preamplifier.
- Plug the measurement microphone directly into the XL2-TA.
- Install the latest firmware in the XL2-TA, available at <https://my.nti-audio.com/support/XL2-TA>.
- Start the XL2 Projector PRO Software. The computer requires online connection to the web.
- Connect the XL2-TA with the USB cable to the Projector PRO software, thus you see the XL2-TA display live on the computer monitor. (if prompted select **COM-Port** on the XL2-TA)
- Press the computer keyboard keys "Ctrl + Shift + F5" at the same time (alternatively "Ctrl + Alt + F5")

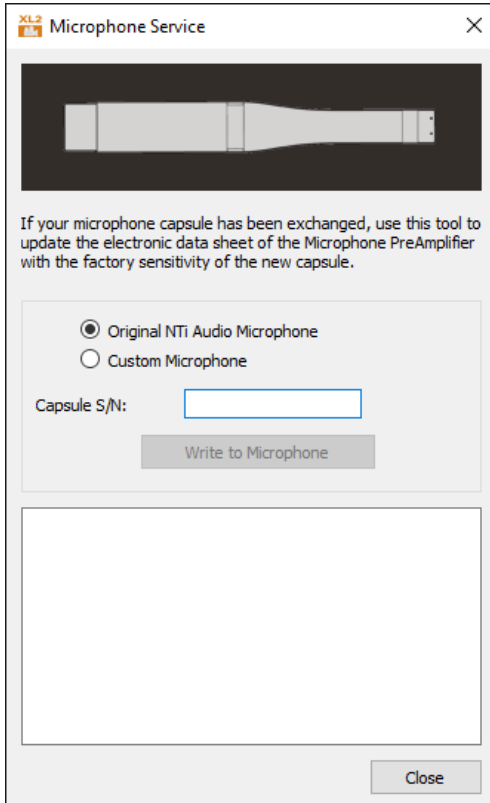

- Select **Original NTi Audio Microphone** or **Custom microphone**.
- Case: Original NTi Audio Microphone
 - Enter the serial number of the new capsule
 - Confirm by clicking **Write to MA220**.
 - Now XL2-TA reads the factory sensitivity of the new capsule from the NTi Audio server and stores the new data into the electronic data sheet of the preamplifier. You will be prompted if all is in good order.
- Case: Custom microphone
 - Enter the microphone sensitivity
 - Confirm by clicking **Write to MA220**.
 - Now XL2-TA stores the microphone sensitivity as factory sensitivity in the electronic data sheet of the MA220 Pre-Amplifier.
- Verify the setting in the "CALIBRATE" screen of the XL2-TA and perform a user calibration to verify if the new capsule works in good order.

22. Further Information

My NTi Audio

Register your instruments at My NTi Audio and benefit from the following possibilities:

- Free updates for your instruments
- Activation of optional product functions
- Premium access to downloads
- Receive application and product news
- Faster worldwide support
- Tracing support in case of loss or theft
- Calibration support

How to Register

- Open the web page “<https://my.nti-audio.com>”
- You are prompted to login or create your My NTi Audio account.
- The web page “My NTi Audio Products” opens.
- Select the product type and enter the serial number.
- Confirm with “Register”.
- Now your product is listed in the table “My Products”.

 Congratulations, your NTi Audio product is registered



Tips and Troubleshooting

Overview

- Resetting to Factory Default
- XL2-TA Starts Up with Limited Functions
- Can I use another SD Card?
- Formatting the SD Card
- SD Card Errors
- Error messages on display
- Stored Data or Wav-files not available on SD Card
- Date and Time Lost

Resetting to Factory Default

If the XL2-TA Audio and Acoustic Analyzer reacts unexpectedly, a reset to the factory settings might solve the problem.

- Switch off the XL2-TA .
- Hold down escape  and simultaneously operate On/Off .

 The XL2-TA starts up and the reset confirmation is displayed.

XL2-TA Starts Up with Limited Functions



The XL2-TA has been operated the last time in one of the simplified application profiles and the system settings have been changed as follows: **Select Profile** from **Yes** to **No**.

- Follow the above resetting to factory default.

 The XL2-TA will start up with full functionality.

Can I use another SD Card?

Yes, you can use any alternative SD Card, such as offered in the chapter Further Information: Accessories.

- Switch off the XL2-TA .
- Insert the SD Card into the XL2-TA Analyzer.
- Switch on the XL2-TA .

 The XL2-TA writes the data structure automatically to the inserted SD Card.

Formatting the SD Card

In case you need to format the SD Card, then we recommend doing so utilizing the software SDFormatter. This software ensures the best performance of your SD Card. SDFormatter is a free download at www.sdcard.org/downloads.

SD Card Errors

The XL2-TA Audio and Acoustic Analyzer writes measurement data automatically onto the SD Card during ongoing measurements, thus a functioning SD Card has to be inserted at all times.

Error Messages

Actions to do

Missing SD-Card

Insert the SD Card.

SD-Card is not FAT formatted

Format the SD Card on the PC. Follow the instructions at Formatting the SC Card in this chapter.

SD-Card is full

The memory of the SD Card is full. Download all data to the PC and empty the SD Card.

Other Error Messages on Display

In case error messages, such as Error 900, Error 901, ..., is shown on the XL2-TA display, then follow "Resetting to Factory Default" in this chapter. These error messages describe a common status information and are not associated with a dedicated issue. If such errors occur frequently, then kindly report the full error message back to NTi Audio for resolution. Thank you.

Stored Data or Wav-files not available on SD Card

The file system might be corrupted.

- On the PC, right-click on the “NTi Audio XL2-TA” drive, select “Properties” and click “Check Now” as shown below.
- Thereafter all stored data should be available again.

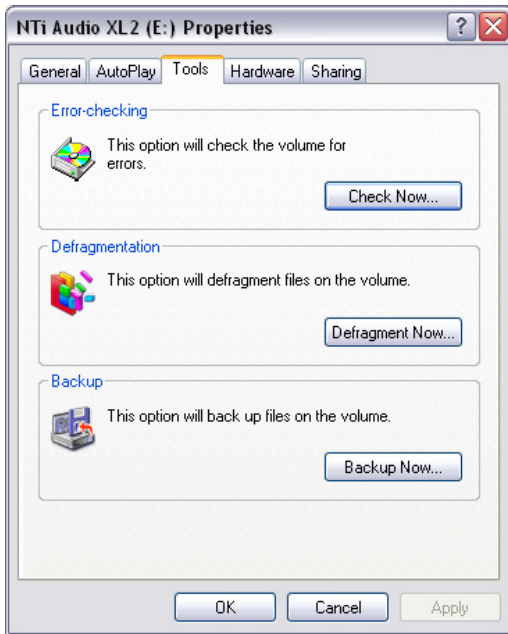

Date and Time Lost

The XL2-TA Analyzer has a small internal battery installed. This powers the real time clock (RTC), and ensures the accurate display of the date and time on the instrument and in the measurement reports, even if the device has been powered down for a period of time. This, so called, RTC battery is soldered on to the internal circuit board. The typical battery lifetime is 8-9 years.

Kindly return the instrument for service. For convenience, this service may be combined with the recommended annual calibration of the XL2-TA Sound Level Meter.

Firmware Update

You will find information about the installed firmware version in the systems settings of the instrument. The firmware revision history is listed on the XL2 Support Page <https://my.nti-audio.com>.

Updating the firmware on the XL2-TA is executed by placing the XL2-TAVxxx.xx file in the root directory of the XL2-TA. When started, the XL2-TA automatically completes the firmware update.



① XL2.htm

This file opens the XL2-TA instrument status page, for online

- Firmware updates
- Activation of options

Firmware update with XL2-TA in hand, PC online:

- Start the XL2-TA and connect it to the PC.
- The XL2-TA displays the pop-up window USB Mode.
- Select Mass storage. The PC thus recognizes the XL2-TA as a mass storage device.
- Double-click the file XL2.htm ①. The web screen “XL2-TA Instrument Status” opens.
- Select “Look for FW Updates”: The web screen “XL2 Support Page” opens.
- Compare the firmware version to the latest version available.
- If an update is required, download and save the firmware file XL2-TAVxxx.xx into the XL2-TA root directory (the root directory shows the folders “Projects”, “XL2-TA_SYS”, the file “XL2.htm” and others).
- Remove the USB cable and power up the XL2-TA ②.
- Watch the display and wait until the update is finished.
- All settings are back to factory default. Adjust the display and reporting settings according your requirements.

No PC available

If you have no web access at all, please contact the local NTi Audio partner.

Options

The **System** menu shows the installed options on the XL2-TA. The following options extend the measurement functions of the XL2-TA:

Extended Acoustic Pack

NTi Audio #: 600 000 339

The Extended Acoustic Pack offers the following additional features for sound level- and acoustic measurements.

- SLMeter/RTA function
 - Recording of linear wav-files (24 bit, 48 kHz)
 - Percentiles for wide band and spectrum with flexible setting from 0.1% to 99.9%
 - Sound Exposure Level L_{AE}
 - 100 ms logging
 - RTA logging of L_{min} and L_{max}
 - Event-triggered audio and data recording
 - Time weighting: Impulse (L_{xI} , L_{xleq} with $x = A, C, Z$)
 - True peak level in 1/1 and 1/3 octave resolution
 - Clock-impulse maximum level (TaktMax) in accordance with DIN 45645-1 and DIN 45657
 - Impulsiveness detection in accordance with BS4142:2014 and NordTest ACOU 112

- FFT function
 - High-resolution Zoom-FFT with selectable frequency ranges and resolution up to 0.4 Hz in the range of 5 Hz to 20 kHz
 - Recording of linear wav-files (24 bit, 48 kHz)
- RT60 function
 - Reverberation time in 1/3 octave resolution
- 1/12 octave Spectral Analyzer (requires Spectral Limits Option)
 - Recording of linear wav-files (24 bit, 48 kHz)

Projector PRO Option

NTi Audio #: 600 000 439

The Projector PRO option enables the following two additional functions to the Projector PRO software:

- “XL View” for large screen dB level display
- “Sound Level Predictor” that indicates the headroom for the next few minutes during live sound mixing

Speech Intelligibility STIPA

NTi Audio #: 600 000 338

The XL2-TA Analyzer measures the speech intelligibility according to the latest revision of standard IEC 60268-16:2020 (edition 5) and older editions. It includes ambient noise correction and automated averaging of measurements. The XL2-TA displays the measurement results as STI or as CIS results, accompanied by the individual levels and modulation indices of the seven octave bands.

The measurement results are acquired from the dedicated STIPA test signal source:

- NTi Audio TalkBox, acoustic signal generator required for audio systems with voice microphones, thus measuring the complete signal chain
 - Minirator MR-PRO, test signal generator required for audio systems with line inputs
 - Other Audio Players
- Register the XL2-TA and download the STIPA test signal at <https://my.nti-audio.com/support/XL2-TA>

Remote Measurement Option

NTi Audio #: 600 000 375

The Remote Measurement option allows the real-time acquisition of XL2-TA measurement data directly into a computer application via USB. The option adds a real-time acquisition facility to the Sound Insulation Reporter software.

Alternatively you can write your own unique measurement applications for sound level monitoring or automated measurements, e.g. with MS Excel or LabView. A documented command set for data retrieval via USB is available. The following XL2-TA measurement functions are supported:

- Sound level meter and spectrum analyzer SLMeter/RTA
- Vibration Meter VibMeter
- FFT Analyzer + Tol
- RT60 Reverberation time
- Audio analyzer RMS/THD+N
- High-resolution RTA function 1/12 Oct + Tol

The Remote Measurement Option includes the functionality available in the Projector PRO option.

Spectral Limits Option

NTi Audio #: 600 000 376

The Spectral Limits Option extends the XL2-TA function range in both, the sound and vibration mode. It adds noise curves, trace capturing, relative curve display and comprehensive tolerance handling for the FFT Analysis and high-resolution spectral analysis up to 1/12th octave. The vibration mode is enabled upon installing the vibration option.

- FFT and 1/12 octave Analyzer
 - Capturing of multiple readings into the internal memory
 - Comparing measurement results against captures with relative or absolute curve display
 - Comprehensive tolerance handling with tolerance masks based on captures for passed/failed measurements
- 1/12 octave Spectral Analyzer
 - High-resolution spectral analyzer 1/12 Oct + Tol
 - Selectable 1/1, 1/3, 1/6 and 1/12 octave resolution
 - Frequency band listening at rear speaker
 - Sound Mode: 11.5 Hz to 21.8 kHz
 - Vibration mode: 0.73 Hz to 1.36 kHz
- FFT Analyzer
 - High-resolution Zoom-FFT with selectable frequency ranges and resolution up to 0.4 Hz in the range of
 - Sound mode: 5 Hz to 20 kHz
 - Vibration mode: 1 Hz to 20 kHz
- Sound Level Meter
 - True peak level in 1/1 and 1/3 octave resolution (disabled with type approved firmware)
- Noise Curves
 - In accordance with ANSI S12.2-2019, -1995 and ISO 1996

Type Approval Option

NTi Audio #: 600 000 377

The Type Approval Option upgrades the instrument to the XL2-TA, the sound level meter dedicated to certified measurements. The XL2-TA with the M2230 or M2340 microphone forms a type approved sound level meter offering class 1 performance in accordance with IEC61672, IEC61260 and ANSI S1.4.

The Type Approval Option includes

- XL2-TA Firmware V4.71 (approved Firmware)
- Sticker XL2-TA
- XL2-TA Manual (available online at www.nti-audio.com/XL2)

How do I get my XL2-TA ready for accreditation?

- Install the Type Approval Option on the XL2-TA and apply the XL2-TA sticker on top of the XL2-TA label on the display.
- Download the dedicated firmware for accreditation to your XL2-TA from the XL2 Support Page at <https://my.nti-audio.com>.
- After the firmware installation, the XL2-TA starts with a pop-up window "**XL2-TA Type Approved SLM/RTA**". The sound level meter function SLM/RTA may be accredited now.

The type approved firmware deactivates the X-Curve in the SLM function and the unit SPL in the RMS/THD+N function.

XL2-TA Vibration Option

NTi Audio #: 600 000 436

The Vibration Option turns the XL2-TA Analyzer into a professional vibration meter with broadband measurements and spectral analysis in 1/3 or octave resolution. The XL2-TA Vibration Meter determines vibration acceleration, velocity and deflection with standard-compliant weighting filters in the frequency range from 0.8 Hz to 2.5 kHz. Detailed recording of measurement data and audio files allow for comprehensive evaluation and reporting. In addition, the XL2-TA Vibration Meter comes standard with an FFT analysis and an oscilloscope function. Selectable FFT frequency ranges from 1 Hz to 1.69 kHz allow a detailed examination of the measured vibrations.

The Spectral Limits Option adds functions to the Vibration Meter including a zoom FFT up to 20 kHz and a 1/12 octave band analysis from 0.73 Hz to 1.36 kHz. Also, it adds the ability to record reference spectra and set tolerances for pass / fail quality control measurements. The Remote Measurement Option allows the real-time acquisition of measurement data directly into a computer application via the USB interface. A documented command set is available.

The Vibration Option is supported by the XL2-TA with firmware V4.11 or higher.

Cinema Meter Option

NTi Audio #: 600 000 379

The Cinema Meter Option forms the dedicated solution for efficient calibration and repetitive verification of cinema loudspeaker systems according to the SMPTE ST 202:2010, SMPTE RP 200:2012 and ISO 2969:2015 standards. An interactive assistant guides the user through dedicated measurement procedures.



Create new cinema

Generates measurement templates according to the cinema size with dedicated X-curve selection.

- **Calibrate cinema**

Calibration menu for reference data recording of each channel as well as headroom tests and averaging measurement results of different microphone positions

- **Verify Cinema**

Verification menu for periodical cinema measurements and comparison against the reference data

- **Lock into Verify Mode**

Locks the XL2-TA Analyzer in the Verify Cinema mode. After powering off the instruments starts up directly in the Verify Mode again. The user may unlock the instrument anytime.

- **View verification results**

Displays measurement deviations of periodical measurement against reference data.

- **Exit**

Returns back to other XL2-TA measurement functions.

The Cinema Meter Option consists of

- Spectral Limits Option
NTi Audio # 600 000 376
- Cinema Assistant Option
NTi Audio # 600 000 378

XL2 Data Explorer Permanent

NTi Audio #: 600 000 430

The Data Explorer Permanent license enables the import of logged sound level data into the Data Explorer software, a PC-based software application with a powerful data processor for easy and fast analysis of noise monitoring data.

Visualize, analyze and control millions of data points with this tool that is dedicated to acoustic consultants and noise measurement professionals. It provides a convenient way to view and manage your data and quickly create customized reports.

Features of the XL2 Data Explorer software:

- Data visualization
- Fast zoom and pan
- Audio playback synchronized to graph
- Markers with on-the-fly calculations
- Automated tonal and impulsive marker generation
- Percentile levels Ln and Rating level Lr calculation
- Customized Reporting

Data Explorer 365

NTi Audio #: 600 000 431

Annual subscription service for one XL2-TA Sound Level Meter.

XL2 Sound Insulation Permanent

NTi Audio #: 600 000 432

The Sound Insulation Permanent license enables the import of measurement data into the Sound Insulation Reporter software.

Sound Insulation Reporter is a PC-based software application that provides all the standard reports for Airborne, Impact and Facade sound insulation measurements. Designed for acoustic consultants, this comprehensive tool uses data gathered by the XL2-TA Sound Level Meter, and quickly returns graphical analysis of all measurement positions.

Features of the Sound Insulation Reporter software:

- Airborne, Impact and Facade Sound Insulation
- Visualization of all measurement data
- Customized Reporting
- Standards ASTM E336, ASTM E413, ASTM E1007, ASTM E989, ASTM E966, ASTM E1332, BB93, DIN 4109, Document E, GB/T 19889, ISO 16283, ISO 140, ISO 717, ISO 10140, NEN 5077:2019, SIA 181:2006, SIA 181:2020

Sound Insulation Reporter 365

NTi Audio #: 600 000 433

Annual subscription service for one XL2-TA Sound Level Meter.

XL2 Room Acoustics Permanent

NTi Audio #: 600 000 440

The Room Acoustics Permanent license enables the import of measurement data into the Room Acoustics Reporter software.

The Room Acoustics Reporter is a PC software for automatically generating reverberation time measurement reports and analyzing the RTA frequency response spectrum. The software supports acousticians and experts in the visualization and detailed evaluation of measurement data recorded with the XL2-TA Sound Level Meter.

Features:

- Room acoustic simulation according to Sabine or Eyring
- Import of own sound absorber database and tolerances
- Frequency response spectrum and Noise Curves

Room Acoustics Reporter 365

NTi Audio #: 600 000 441

Annual subscription service for one XL2-TA Sound Level Meter.

The following standards are supported

- IEC 61260: Octave-band and fractional-octave-band filters
- GB 50371 - Code for sound reinforcement system design
- ANSI/ASA S12.2-2019 - Noise criteria curves NC
- ANSI/ASA S12.2-2019 - Room noise criterion RNC
- DIN 15996:2020 - Grenzkurven GK
- ISO R 1996-1971 - Noise rating curves NR
- ASR A3.7:2021 - Working Place
- DIN 18041: 2016 - Acoustic quality in rooms
- ISO 3382-1:2009 - Reverberation time in performance spaces
- ISO 3382-2:2008 - Reverberation time in ordinary rooms
- ÖNORM B 8115-3:2015 - Room Acoustics
- ASTM C423-17 - Sound Absorption
- ISO 354:2003 - Sound absorption in a reverberation room

XL2 Sound Power Permanent

NTi Audio #: 600 000 434

The Sound Power Permanent license enables the import of measurement data into the Sound Power Reporter software.

Sound Power Reporter is a PC-based software application that provides all the standard reports for sound power measurements. Designed for industrial professionals, this comprehensive tool uses data gathered by the XL2-TA Sound Level Meter, and quickly returns graphical analysis of all measurement positions.

Features of the Sound Power Reporter software:

- Visualization of all measurement
- Customized Reporting
- Standards ISO 3741, ISO 3744, ISO 3746, ANSI-ASA S12.51, S12.54, S12.56

Sound Power Reporter 365

NTi Audio #: 600 000 435

Annual subscription service for one XL2-TA Sound Level Meter.

Installation of Options

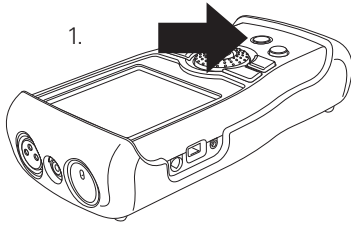

1. Power On XL2-TA

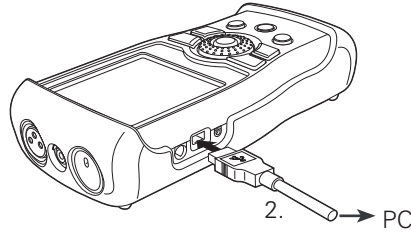

2. → PC

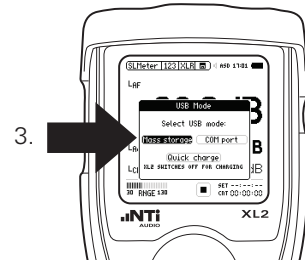

3. Mass storage

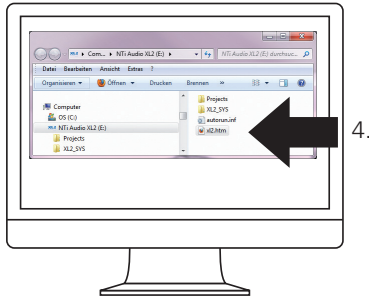

4. Open XL2.htm

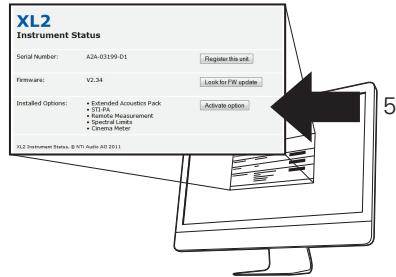

5. Activate option



6. Login
(<https://my.nti-audio.com>)



Insert License number





Get Activation Key



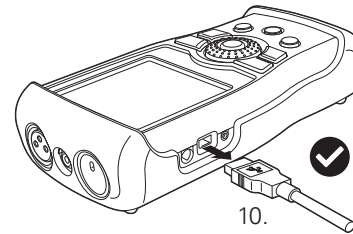

Download activation file and copy to XL2-TA (xx_0xxxx.txt)

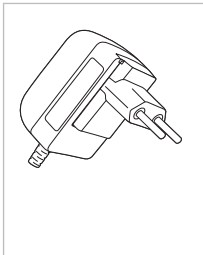

Accessories

	<p>Manufacturer Calibration Certificate</p> <p>The calibration certificate lists the individual product data with serial number. The calibration and adjustment procedures follow the documentation and traceability requirements of the EN ISO / IEC 17025 standard. Annual re-calibration of the instrument is recommended ensuring accurate measurements.</p> <p>NTi Audio # 600 000 018</p>
	<p>Ever-ready Pouch</p> <p>The Ever-ready Pouch protects the XL2-TA during transport and operation. With its convenient belt-clip, the XL2-TA can be kept close-by for those tasks requiring both hands. The Ever-ready Pouch allows operation of the XL2-TA while fitted in the pouch.</p> <p>NTi Audio #: 600 000 335</p>

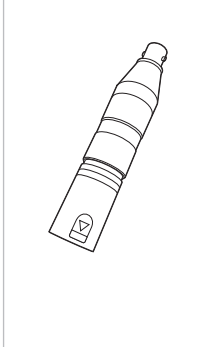
	<p>Mains Power Adapter</p> <p>Mains Power Adapter the XL2-TA Audio and Acoustic Analyzer with removable plug types. The Mains Power Adapter suits the typical power sockets in Australia, China, Europe, Japan, US and UK.</p> <p>NTi Audio #: 600 000 333</p>
	<p>Spare Li-Po Battery</p> <p>Rechargeable spare battery for portable measurements at any time.</p> <p>NTi Audio #: 600 000 337</p>
	<p>ICP Adapter ASD</p> <p>The ICP Adapter connects to the XL2-TA and generates ICP power supply for accelerometers and other custom sensors. The adapter offers an electronic data sheet, which stores the sensitivity and individual serial number of the connected sensor.</p> <p>NTi Audio #: 600 010 223</p> <p>ICP is a registered trademark of PCB Piezotronics.</p>

	<p>XLR Adapter ASD</p> <p>XLR male/female Adapter with electronic data sheet for automated sensor detection (ASD) of other sensors. The adapter is available in two variations: The type ASD-2 is used for measurement microphones with isolated housing ground connection and the type ASD for induction loop and other sensors.</p> <p>NTi Audio #:</p> <ul style="list-style-type: none"> • XLR Adapter ASD: 600 000 383 • XLR Adapter ASD-2: 600 000 385
	<p>Exel System Case</p> <p>This compact system case provides the professional transport protection for work in the field. It offers space for the hand-held instruments, cables and connectors.</p> <p>NTi Audio #: 600 000 334</p>

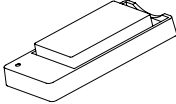
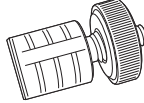
	<p>Battery Charger</p> <p>The Battery Charger efficiently recharges the spare battery whilst you are using your XL2-TA Audio and Acoustic Analyzer. One spare Li-Po battery is included with the battery charger.</p> <p>NTi Audio #: 600 000 332</p>
	<p>XL2-TA Mounting Adapter</p> <p>This mechanical adapter piece mounts the XL2-TA on a microphone stand. Adapters for 3/8" or 5/8" stands are included.</p> <p>NTi Audio #: 600 000 372</p>
	<p>Ball Head Mount</p> <p>This flexible universal joint mounts the XL2-TA on a 1/4" or 3/8" stand. It provides the facility to mount the XL2-TA at any angle.</p> <p>NTi Audio #: 600 000 387</p> <p>A 5/8" stand requires additionally the Mounting Adapter, # 600 000 372.</p>

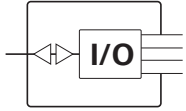

Digital I/O Adapter PCB

The Digital I/O Adapter serves to control external peripheral devices, such as indicating sound levels that exceed limits on a big external red-orange-green lamp. It connects to the digital I/O interface.

NTi Audio #: 600 000 380



XL2 Input Keypad

The XL2 Input Keypad offers four marker keys to trigger an event recording or categorize any noise during measurements. Requires the optional Extended Acoustic Pack.

NTi Audio #: 600 000 384

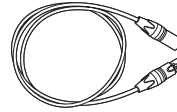

ASD Cable

The ASD Cable allows for extended connections of the NTi Audio measurement microphones. It supports the transfer of the electronic data sheet from the microphone to the XL2-TA Analyzer.

NTi Audio #:

- 5 meter (16 foot): 600 000 336
- 10 meter (32 foot): 600 000 364
- 20 meter (64 foot): 600 000 365

The ASD technology for the electronic data sheet transfer is applicable for a cable length of up to 20 meters (64 feet).

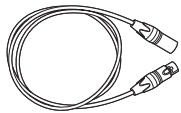
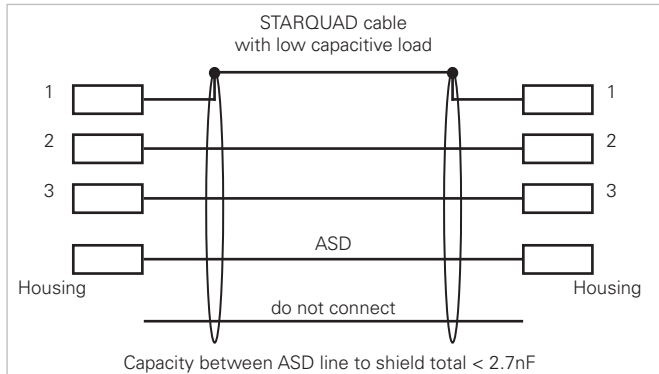

ASD Flat Ribbon Cable 1m

Microphone cable for passing closed windows or doors. It supports the transfer of the electronic data sheet from the microphone to the XL2-TA Analyzer.

NTi Audio #: 600 000 367

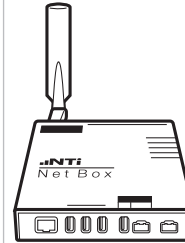

NetBox

The NetBox connects the XL2-TA Sound Level Meter to the internet for unattended noise monitoring. It transfers the measurement data to the fully-managed NoiseScout Web Portal in real time or provides a secure internet FTP access to the instrument. The noise monitor may be connected via 3G, 4G, 5G, LAN or Wi-Fi (an external modem is required for 4G/5G).

NTi Audio #:

- NetBox (LAN & Wi-Fi): 600 000 450
- NetBox with 3G-Modem, LAN & Wi-Fi: 600 000 458
- NoiseScout 365
(subscription service for one year)
or Data Credits
 - 30 Days: 600 000 490
 - 100 Days: 600 000 491
 - 366 Days: 600 000 492
 - 1096 Days: 600 000 493

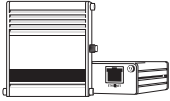

4G/LTE Gateway

The 4G/LTE Gateway is a small, lightweight, and energy-efficient industrial gateway equipped with mission-critical LTE capabilities, Gigabit Ethernet interface, digital Inputs/Outputs, and micro-USB port.

This 4G/LTE Gateway has been specially selected for use with the XL2-TA Sound Level Meter. It connects XL2-TA+NetBox to the internet for remote monitoring of noise levels.

NTi Audio #:

- 600 076 011
4G/LTE Gateway for NetBox
(worldwide excluding Americas, China, Japan)
- 600 076 012
4G/LTE Router for NetBox
(worldwide)

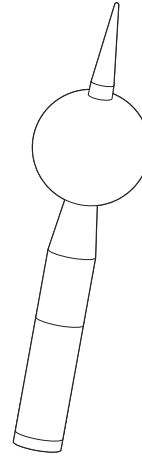

WP30 Weather Protection

Protect your measurement microphones M2230 and M2340 from rain, wind, dust and perching birds with this professional outdoor weather protection kit. Ideal for precise acquisition of environmental noise data in outdoor applications.

Features

- Class 1 compliant with IEC 61672 and ANSI S1.4 for vertical and horizontal sound incidence
- Protection from rain and dust (IP54), wind and perching birds
- Built from corrosion-free materials
- Removable top section for easy microphone calibration
- Standard 3/8" tripod mount
- Weight: 270 g (9.5 oz.)
- Optional Pole Mount Adapter
- Optional sturdy outdoor carrying case available

NTi Audio # 600 040 060

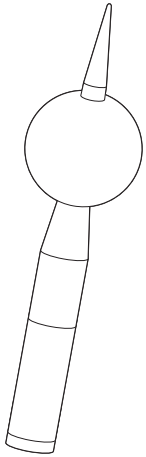

WP61 Weather Protection for M4261

Protect your M4261 microphone from rain, wind, dust and perching birds with this professional outdoor weather protection kit.

Features

- Class 2 compliant with IEC 61672 and ANSI S1.4 for vertical and horizontal sound incidence
- Protection from rain and dust (IP54), wind and perching birds
- Built from corrosion-free materials
- Removable top section for easy microphone calibration
- Standard 3/8" tripod mount
- Weight: 270 g (9.5 oz.)
- Optional Pole Mount Adapter
- Optional sturdy outdoor carrying case available

NTi Audio # 600 040 080

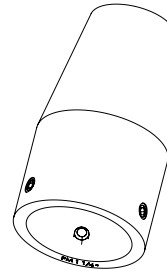

Pole Mount Adapter

The outdoor measurement microphone may be installed on a pole using this adapter. The microphone is connected to the sound level meter by the ASD cable, which runs through the pole and the adapter to the microphone. The adapter is available in two different sizes.

NTi Audio #:

- 600 040 067
Pole Mount Adapter PM 1"
supports pole diameter 25 - 33 mm
(1-1.3")
- 600 040 068
Pole Mount Adapter PM 1 1/4"
supports pole diameter 32 - 44 mm
(1.25-1.75")

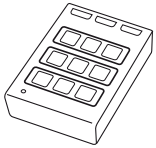

Limit Light

The XL2-TA Audio and Acoustic Analyzer in combination with this Limit Light offers a turnkey solution for live sound monitoring. The sound level limits are set in the XL2-TA. The Limit Light provides a pre-warning with an orange light and indicates that levels have been exceeded with a red light.

NTi Audio #: 600 000 600

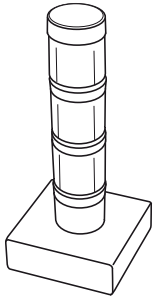

Stack Light

The XL2-TA Audio and Acoustic Analyzer in combination with this Stack Light provides a turnkey solution for noise level monitoring or passed / failed measurements where a prominent visual indication is required. The Stack Light connects directly to the XL2-TA Analyzer and shows the actual measurement result with three different colors; green, orange and red.

NTi Audio #: 600 000 610



Class 1 Sound Calibrator

The battery-operated Class 1 Sound Calibrator is classified for the calibration of class 1 measurement microphones, sound level meters and other acoustic measurement equipment. This precision microphone calibrator delivers 94 or 114 dB at a frequency of 1 kHz.

NTi Audio #: 600 000 388

The optional 1/4" adapter ADP-1/4-P is required to fit 1/4" measurement microphones.

NTi Audio #: 600 000 391

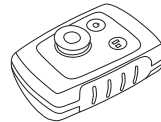

Class 2 Sound Calibrator

The battery-operated Class 2 Sound Calibrator is classified for the calibration of class 2 measurement microphones, sound level meters and other acoustic measurement equipment. This microphone calibrator delivers 114 dB at a frequency of 1 kHz.

NTi Audio #: 600 000 394

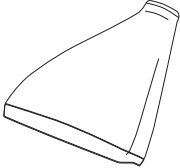
	<p>Weatherproof Enclosure for Noise Monitoring Terminal</p> <p>The weatherproof enclosure is the tailored fixed installation solution for unattended noise monitoring. The enclosure is IP66 rated, highly secure and constructed of strong, hard-wearing reinforced fiberglass.</p> <p>NTi Audio #: 600 000 480</p>
	<p>Shroud MXA01</p> <p>The Shroud reduces the acoustic reflections from the XL2-TA housing back to the microphone capsule for precision class 1 measurements. It supports the XL2-TA in combination with the 1/2" measurement microphones M2230, M2340, M2211 and M2215. The Shroud is included within the Type Approval Option.</p> <p>NTi Audio #: 600 040 110</p>

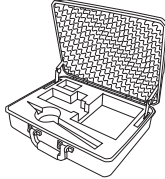
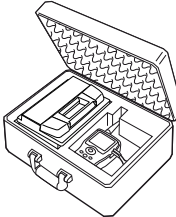
	<p>Basic Outdoor Case</p> <p>The Basic Outdoor Case is a simple and efficient solution for outdoor noise monitoring. Powered either by an external mains supply or a small, high-capacity battery pack, the case is more than adequate for a number of days of monitoring. The robust and lightweight design protects the XL2-TA and accessories from a wide range of inclement weather conditions.</p> <p>NTi Audio #:</p> <ul style="list-style-type: none"> • IP43 rating: 600 000 471 • IP63 rating: 600 000 473
	<p>Heavy-duty Outdoor Case</p> <p>The heavy-duty outdoor case is a professional solution for short- and medium-term unattended noise monitoring. The case provides comprehensive protection against dust, water and impacts. Internal dimensions provide ample space for battery packs to power the XL2-TA Sound Level Meter.</p> <p>NTi Audio #:</p> <ul style="list-style-type: none"> • IP43 rating: 600 000 476 • IP65 rating: 600 000 477

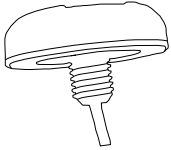

GPS Receiver (customized)

The specially adapted GNSS receiver comes with a built-in active antenna in a white housing. It connects to the XL2-TA Sound Level Meter and the NetBox. Typical applications are to synchronize the start time of one or multiple XL2-TAs precisely with the GPS signal (+/- 0.7 ms) or presenting the precise instrument position in NoiseScout Gateway mode for unattended noise and vibration monitoring. The GNSS receiver supports Galileo, GPS and other systems.

NTi Audio #: 600 000 357

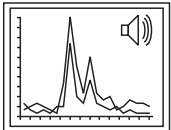

Data Explorer Software

Data Explorer is a PC-based software application with a powerful data processor for easy and fast analysis of sound level measurement data. The data import requires that the Data Explorer Option be installed on the XL2-TA. Download the software at <https://my.nti-audio.com>.

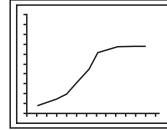

Sound Insulation Reporter Software

Sound Insulation Reporter is a PC-based software application that provides all the standard reports for Airborne and Impact sound insulation measurements. The Sound Insulation Option enables the import of measurement data into the Sound Insulation Reporter software. Download the software at <https://my.nti-audio.com>.

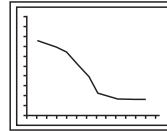

Room Acoustics Reporter Software

The Room Acoustics Reporter is a PC software for automatically generating reverberation time measurement reports and analyzing the RTA frequency response spectrum. The Room Acoustics Option enables the import of measurement data into the Room Acoustics Reporter software. Download the software at <https://my.nti-audio.com>.

	<p>Sound Power Reporter Software</p> <p>Sound Power Reporter is a PC-based software application that provides all the standard reports for sound power measurements. The Sound Power Option enables the import of measurement data into the Sound Power Reporter software. Download the software at https://my.nti-audio.com.</p>
	<p>XL2 Projector PRO Software</p> <p>The Projector PRO software displays the XL2-TA screen in real-time on your PC when connected by USB. The Projector PRO option enables the “XL View” and “Sound Level Predictor” for live sound monitoring. Free download from the XL2 Support Page at https://my.nti-audio.com.</p>
	<p>1/2" Windscreen 90 mm</p> <p>for M2230, M2340, M2211 and M2215 measurement microphone</p> <p>NTi Audio #: 600 040 109</p>

	<p>WP30/WP61 Windscreen Replacement</p> <p>The replacement package contains two spare windscreens for outdoor measurement microphones. The outdoor windscreen is recommended to be replaced annually.</p> <p>NTi Audio #: 600 040 061</p>
	<p>8 GB SD Card (default)</p> <p>1x included with XL2-TA</p> <p>NTi Audio #: 600 000 374</p>



SD Card 32 GB

Every 32 GB SD Card is individually tested.

The XL2-TA requires an SD card that can continuously and simultaneously store many data streams. Unfortunately, many cards available on the market are known to interrupt the read/write process for periods of more than 10 seconds. This leads to data loss in the XL2-TA. These interruptions can occur regardless of the speed rating of the card. Even cards of the same type and from the same vendor behave differently depending on the production date. Therefore, to ensure the integrity of the XL2-TA data recording, NTi Audio verifies every single card over a period of several days before the card is sent to our customer. Requires XL2-TA Firmware V4.10 or higher.

Requires XL2-TA Firmware V4.10 or higher.

NTi Audio #: 600 000 386

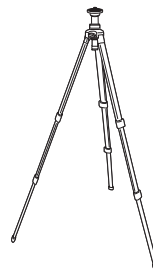

Lightweight Tripod

Retractable, lightweight tripod with 1/4" ball head and 3/8" mounting thread. The flexible ball head mounts the XL2-TA Analyzer at any angle. The tripod is suitable for all measurement microphones, outdoor measurement microphones and the TalkBox.

NTi Audio #: 600 000 397



Minirator MR-PRO

The MR-PRO is an extremely powerful analog audio generator designed for the professional engineer. It generates the following analog audio signals:

- Sine Waveforms, freely selectable frequencies and levels up to +18 dBu
- Sweep Signals, any frequency interval up to 1/12 octave
- White Noise, Pink Noise
- Polarity Test Signal
- Delay Test Signal
- Uploaded wav-files (*.wav)

NTi Audio #: 600 000 310

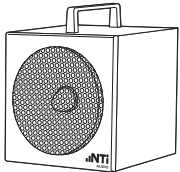
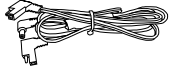
	<p>NTi Audio TalkBox</p> <p>The NTi Audio TalkBox greatly simplifies the acoustic feed of the STIPA intelligibility test source signal into closed sound reinforcement systems. It presents the standardized voice-like acoustic signal emission simulating a human talker in accordance with IEC 60268-16, combined with a certified speech intelligibility signal at standardized levels.</p> <p>NTi Audio #: 600 000 085</p>
	<p>Tracer Battery Adapter Cable</p> <p>The Tracer Battery Adapter Cable connects the Tracer battery pack to a NetBox or an XL2-TA Analyzer. It ensures that the connected instruments start up properly if the battery has been completely discharged.</p> <p>NTi Audio #: 600 000 478</p>

Warranty Conditions

International warranty

NTi Audio guarantees the function of its products and the individual components for a period of one year from the date of sale. During this period, defective products will either be repaired free of charge or replaced.

Limitations

These guarantee provisions do not cover damage caused by accidents, transportation, incorrect use, carelessness, non-original accessories, the loss of parts, operation with non-specified input voltages, adapter types or incorrectly inserted batteries. NTi Audio accepts no responsibility for subsequent damage of any kind. The warranty will be voided by carrying out repairs or services by third parties who are not part of an approved NTi Audio Service Centre.

Statutory Rights

Consumers may have legal (statutory) rights under applicable national laws relating to the sale of consumer products. This warranty does not affect your statutory rights. You may assert any legal rights you have at your sole discretion.

Service and Repairs

If your product is not functioning correctly or is damaged, please contact the local NTi Audio partner for assistance. If the product needs to be returned for service, kindly follow the service guidelines at www.nti-audio.com/service.



Damage through shocks and moisture

- The protective shock jacket shields the instrument against reasonable impacts that could occur in normal use.
- Do not intentionally subject the instrument to extreme stress!
- Please do not drop the instrument!
- Damage caused by dropping or impact is not covered by warranty.
- Do not use the instrument in damp environments! The instrument can be permanently damaged if exposed to moisture.

Calibration Certificate

Your NTi Audio instrument has been tested during manufacture and conforms to the specifications listed in “Technical Data”.

The XL2-TA combination with the appropriate measurement microphone forms a precise class 1 or class 2 sound level meter in accordance with the standards and configurations listed in “Technical Data”.

You may order a manufacturer calibration certificate of your new instrument at the local NTi Audio partner either with or any time after the purchase of the instrument. The certificate lists the individual instrument data with serial number recorded prior to the shipment.

NTi Audio recommends annual calibration of the products starting one year after the purchase. The calibration provides documented and traceable measurement accuracy and confirms that your NTi Audio product meets or exceeds the published specifications. The calibration and adjustment procedures follow the documentation and traceability requirements of the EN ISO / IEC 17025 standard.

For calibrations kindly follow the service guidelines at www.nti-audio.com/service.

Sample Calibration Certificate



Manufacturer Calibration Certificate

The following instrument has been tested and calibrated to the manufacturer specifications.
The calibration is traceable in accordance with ISO/IEC 17025 covering all instrument functions.

- Device Type: **XL2 Audio and Acoustic Analyzer**
- Serial Number: **A2A-11667-E0**
- Date of Calibration: **25 July 2016**
- Certificate Number: **42576-A2A-11667-E0**
- Results: **PASSED**
(for detailed report see next page)

Tested by: M. Frick

Signature:

Stamp:

NTI Audio AG
 Im alten Riet 102
 LI 9494 Schaan
 www.nti-audio.com

Calibration of: XL2 Audio and Acoustic Analyzer
 Serial Number: A2A-11667-E0
 Date: 25 July 2016

• Measurement Data on Receipt: **in tolerance**

• Detailed Calibration Test Results:

	reference	before	actual	unit	actual error	XL2 tolerance	calibration uncertainty ²	
RMS Level @ 1kHz, XLR Input	0.1	0.100	0.100	V	±0.1%	±0.5%	±0.10%	
	1	0.999	1.000	V	±0.1%	±0.5%	±0.09%	
	10	9.987	9.989	V	-0.1%	±0.5%	±0.09%	
Flatness, XLR Input ¹	20 Hz	1	0.997	0.996	V	-0.4%	±1.1%	±0.09%
	20 kHz	1	1.004	1.004	V	0.4%	±1.1%	±0.09%
Frequency	1000	1000.00	999.99	Hz	±0.003%	±0.003%	±0.01%	
Residual Noise	XLR	< 2 uV	< 2 uV			<2 uV	±0.50%	
THD+N @ 0 dBu, 1 kHz, XLR Input		-98.5	-98.9	dB		typ. -100 dB	±0.50%	

• Test Conditions: Temperature: **28.2** °C
Relative Humidity: **51.7** %

• Calibration Equipment Used:

- Agilent Multimeter, Typ 34401A, Serial No. MY 5300 4607
Last calibration: 17.08.2016, Next calibration: 17.08.2017
Calibrated by ELCAL to the national standards maintained at Swiss Federal Office of Metrology, SCS 002

- FX100 Audio Analyzer, Serial No. 10408
Last Calibration: 04.05.2016, Next Calibration: 04.05.2017
Manufacturer calibration based on Agilent 34410, Serial No. MY47014254,
Last Calibration: 03.06.2016, Next Calibration: 03.06.2017
which is calibrated by ELCAL to national standards maintained at Swiss Federal Office of Metrology, SCS 002

¹ The specified tolerance +/0.1 dB @ 1V = +/- 1.1%

² The reported expanded uncertainty is based on a standard uncertainty multiplied by a coverage factor k=2, providing a level of confidence of approximately 95%. The uncertainty evaluation has been carried out in accordance with the regulations of the GUM.

Declaration of Conformity

CE / FCC Compliance Statement



We, the manufacturer NTi Audio AG, Im alten Riet 102, 9494 Schaan, Liechtenstein, do hereby declare that the XL2-TA Analyzer, the measurement microphones M2230, M2340, M2211, M2215, M4261, the preamplifiers MA220, MA230 and accessories, comply with the following standards or other standard documents:

- EMC: 2014/30/EU
- Harmonized standards: EN 61326-1
- Explosive atmospheres (ATEX): 2014/34/EU
- Directive 2011/65/EC on the restriction of the use of certain hazardous substances in electrical and electronic equipment (RoHS).
- Directive 2012/19/EU on waste electrical and electronic equipment (WEEE).

This declaration will become invalid if modifications to the instrument are carried out without the written approval of NTi Audio.

Date: 25. July 2019



Position: COO

Information for Disposal and Recycling

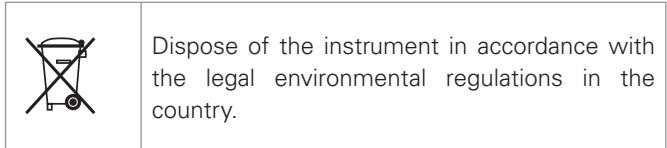

Regulations for the EU and other European countries with corresponding laws

The instrument must not be disposed of in the household garbage. At the end of its service life, bring the instrument to a collecting point for electrical recycling in accordance with the local legal regulations.

Other countries outside the EU

Contact the respective authorities for the valid environmental regulations in the country.

23. Technical Data XL2-TA

All specifications are according to the IEC61672 standard.
Other standards are listed the corresponding specifications.

Sound Level Meter	
Certified Product Configurations Class 1	<ul style="list-style-type: none"> • XL2 with TA-Option, M2230 or M2340 Microphone and Shroud MXA01 form an integrating sound level meter with type approval in accordance with class 1 requirements of IEC 61672 and ANSI S1.4

Conforms with Standards	<ul style="list-style-type: none"> • IEC 61672:2013, IEC 61672:2003, IEC 61260:2014, IEC 61260:2003, IEC 60651, IEC 60804, IEC 61183 • SMPTE ST 202:2010, ISO 2969:2015 • China: GB/T 3785:2010, GB/T 3241, GB 3096-2008, GB 50526, GB-T 4959 • Germany: <ul style="list-style-type: none"> » DIN 15905-5, DIN 45657:2014, DIN 45657:2005, DIN 45645-2 » DIN 45645-1 (optional with Extended Acoustic Pack) • Japan: JIS C1509-1:2005, JIS C 1513 class 1, JIS C 1514 class 0 • Switzerland: V-NISSG • UK: BS 4142:2014, BS 5969, BS 6698 • US: ANSI S1.4:2014, ANSI S1.43, ANSI S1.11:2014, ANSI/ASA S12.60 • International IEC standards are adopted as European standards and the letters IEC are replaced by EN. XL2-TA conforms to these EN standards. • WELL Buildings, LEED Green Building • FGI Facility Guidelines Institute
Weighting	<ul style="list-style-type: none"> • Frequency weighting: A, C, Z (simultaneous) • Time weighting: (simultaneous) <ul style="list-style-type: none"> » Fast, Slow » Impulse (optional with Extended Acoustic Pack)
Level Details	<ul style="list-style-type: none"> • Measurement bandwidth (-3dB): 4.4 Hz - 23.0 kHz • Level resolution: 0.1 dB • Internal noise: 1.3 µV A-Weighted

<p>Audio Recording</p>	<ul style="list-style-type: none"> • Default <ul style="list-style-type: none"> » Recording of compressed wav-files (ADPCM - 4 bit, 24 kHz) » a new wav-file starts every 12 hours (max. wav-file size 512 MB) » Bandwidth: 2.0 Hz - 10.2 kHz • Optional: Extended Acoustic Pack <ul style="list-style-type: none"> » Recording of linear wav-files (24 bit, 48 kHz) » a new wav-file starts every 1 hours (max. wav-file size 512 MB) » Bandwidth: 2.0 Hz - 23.6 kHz • Optional: NoiseScout - Managed Mode <ul style="list-style-type: none"> » Recording of compressed wav-files (4 bit, 12 kHz) » Bandwidth: 2.0 Hz - 5.1 kHz » requires activated "NoiseScout 365" or "Data Day Credits" • Audio files include meta data (scaling, time, ...) in Broadcast Wave Format BWF according to EBU TECH 3285
<p>Measurement Ranges with different microphones</p>	<ul style="list-style-type: none"> • XL2-TA+M2230: 17 dB(A) - 137 dB • XL2-TA+M2340: 18 dB(A) - 138 dB • XL2-TA+M2215: 25 dB(A) - 153 dB • XL2-TA+M2211: 21 dB(A) - 144 dB • XL2-TA+M4261: 27 dB(A) - 146 dB <p>@ typical microphone sensitivity</p>
<p>Linear Measurement Range acc. IEC61672 / ANSI S1.4</p>	<ul style="list-style-type: none"> • XL2-TA+M2230: 24 dB(A) - 137 dB, 27 dB(C) - 137 dB • XL2-TA+M2340: 25 dB(A) - 138 dB, 28 dB(C) - 138 dB • XL2-TA+M2215: 33 dB(A) - 153 dB • XL2-TA+M2211: 29 dB(A) - 144 dB • XL2-TA+M4261: 33 dB(A) - 146 dB <p>@ typical microphone sensitivity</p>

<p>Stabilization Time</p>	<p>< 10 seconds</p>
<p>Integration Time</p>	<ul style="list-style-type: none"> • Minimum: 1 second • Maximum: 100 hours minus 1 second
<p>Display Measurement Ranges</p>	<p>Three level ranges depending on the microphone sensitivity with manual setting. For example:</p> <ul style="list-style-type: none"> • M2230, M2340 @ sensitivity = 42 mV/Pa <ul style="list-style-type: none"> » LOW, lower level range: 0 - 100 dBSPL » MID, mid-level range: 20 - 120 dBSPL » HIGH, upper level range: 40 - 140 dBSPL • M2215 @ sensitivity = 8 mV/Pa <ul style="list-style-type: none"> » LOW, lower level range: 20 - 120 dBSPL » MID, mid-level range: 40 - 140 dBSPL » HIGH, upper level range: 60 - 160 dBSPL • M2211 @ sensitivity = 20 mV/Pa <ul style="list-style-type: none"> » LOW, lower level range: 10 - 110 dBSPL » MID, mid-level range: 30 - 130 dBSPL » HIGH, upper level range: 50 - 150 dBSPL • M4261 @ sensitivity = 16 mV/Pa <ul style="list-style-type: none"> » LOW, lower level range: 10 - 110 dBSPL » MID, mid-level range: 30 - 130 dBSPL » HIGH, upper level range: 50 - 150 dBSPL

Residual noise in [dB] @ S = 42 mV/Pa of XL2-TA without measurement microphone

- Frequency weighting A

Level range	L _{eq}	L _{peak}
LOW	4	17
MID	18	31
HIGH	43	55

- Frequency weighting C

Level range	L _{eq}	L _{peak}
LOW	3	16
MID	17	30
HIGH	41	55

- Frequency weighting Z

Level range	L _{eq}	L _{peak}
LOW	7	20
MID	21	34
HIGH	46	58

Measurements

- SPL actual, Lmin, Lmax, Lpeak, Leq, Lp
- Gliding LAeq and LCEq with selectable time window from one second to one hour (=running Lxeq or sliding Lxeq with x= A or C)
- All measurement results simultaneously available
- Correction value measurement wizard based on LAeq, LCEq and LCpeak
- Noise exposure level LEX with post-processing
- Logging all data or subsets in selectable intervals
- Recording of voice notes
- Monitoring of sound levels that exceed limits
- Digital I/O interface for external peripherals control

Real-Time Analyzer RTA

- Conforms with class 1 of IEC 61260:2014 and ANSI S1.11-2014
- 1/1 octave band display: 8 Hz - 16 kHz sub ranges 8 Hz - 4 kHz or 31.5 Hz - 16 kHz
- 1/3 octave band display: 6.3 Hz - 20 kHz sub ranges 6.3 Hz - 8 kHz or 20 Hz - 20 kHz
- Level resolution: 0.1 dB
- Measurement Units: Volt, dBu, dBV and dB SPL
- Band pass filters (base 10) conform with class 1 of IEC 61260:2014 and ANSI S1.11-2014
 - » 1/1 octave spectrum: > 16 Hz band
 - » 1/3 octave spectrum: > 16 Hz band
- Broadband A/Z levels simultaneously
- Frequency weighting: X-Curve @ 500 seats in accordance with SMPTE ST 202:2010 and ISO 2969:2015 (not available for XL2-TA)
- Capturing of a single reading into the internal memory for comparative measurements
- Leq logging

Remote Measurement (optional)	<ul style="list-style-type: none"> • Querying measurement data online via the USB interface of the following functions: <ul style="list-style-type: none"> » Sound level meter and spectrum analyzer SLMeter/RTA » FFT analyzer » RT60 reverberation time » Audio analyzer RMS/THD+N » High-resolution spectral analyzer 1/12 Oct + Tol • Typical response time: 10 ms @ querying the frequency spectrum in SLMeter
-------------------------------	---

Functions of Extended Acoustic Pack (optional)	<ul style="list-style-type: none"> • SLMeter/RTA function <ul style="list-style-type: none"> » Recording of linear wav-files (24 bit, 48 kHz) a new wav-file starts every 1 hour (max. wav-file size 512 MB) » Percentiles for wide band, 1/1 and 1/3 octave spectrum <ul style="list-style-type: none"> - Flexible setting from 0.1% to 99.9% - Sampling: every 1.3 ms - Wide band: in 0.1 dB wide classes, based on sampling L_{xy} (x= A, C or Z, y= F, S or EQ₁") - 1/1 and 1/3 octave spectrum: in 1.0 dB wide classes, based on L_{xy} (x= A, C or Z, y= F or S) - Dynamic range: 140 dB » Sound Exposure Level LAE » 100 ms logging » RTA logging of Lmin and Lmax » Event-triggered audio and data recording » Time weighting: Impulse (LxI, Lxleq with x= A, C, Z) » True peak level in 1/1 and 1/3 octave resolution » Clock-Impulse Maximum Level (TaktMax) in accordance with DIN 45645-1 and DIN 45657 » Impulsiveness detection in accordance with BS4142:2014 and NordTest ACOU 112 • FFT function <ul style="list-style-type: none"> » High-resolution Zoom-FFT with selectable frequency ranges and resolution up to 0.4 Hz in the range of 5 Hz to 20 kHz » Recording of linear wav-files (24 bit, 48 kHz) • RT60 function <ul style="list-style-type: none"> » Reverberation time in 1/3 octave resolution • 1/12 octave Spectral Analyzer (requires Spectral Limits Option) <ul style="list-style-type: none"> » Recording of linear wav-files (24 bit, 48 kHz)
--	---

<p>Functions of Spectral Limits Option (optional)</p>	<ul style="list-style-type: none"> • SLMeter/RTA function <ul style="list-style-type: none"> » True peak level in 1/1 and 1/3 octave resolution • FFT function <ul style="list-style-type: none"> » High-resolution Zoom-FFT with selectable frequency ranges and resolution up to 0.4 Hz » Sound mode: 5 Hz to 20 kHz » Vibration mode: 1 Hz to 20 kHz • 1/12 octave function <ul style="list-style-type: none"> » High-resolution RTA function “1/12 Oct + Tol” » Selectable 1/1, 1/3, 1/6 and 1/12 octave spectral resolution » Frequency band listening at rear speaker » Sound Mode: 11.5 Hz to 21.8 kHz » Vibration mode: 0.73 Hz to 1.36 kHz • FFT and 1/12 octave function <ul style="list-style-type: none"> » Capturing of multiple readings into the internal memory » Comparing measurement results against captures with relative or absolute curve display » Comprehensive tolerance handling with tolerance masks based on captures for passed/failed measurements » Export and import of tolerance and capture files • Noise Curves <ul style="list-style-type: none"> » Noise Rating NR according to ISO/R 1996-1971 » Noise Criteria NC in accordance with ANSI S12.2-2019 and -1995 » Room Noise Criteria RNC in accordance with ANSI S12.2-2019 » Room Criteria RC in accordance with ANSI S12.2-1995 » Preferred Noise Criteria in accordance with ASA 1971
---	--

Reporting and Analysis Software	
<p>Data Explorer (optional)</p>	<ul style="list-style-type: none"> • Enables the import of measurement data into the Data Explorer software • Powerful data processor for easy and fast analysis of sound level measurement data on PC
<p>Sound Insulation Reporter (optional)</p>	<ul style="list-style-type: none"> • Enables the import of RTA and reverberation time measurement data in 1/3 octave band resolution into the XL2 Sound Insulation Reporter software • Software provides all tools for fast data analysis and standardized reporting of airborne, impact and facade sound insulation measurements on PC • Standards ASTM E336, ASTM E413, ASTM E1007, ASTM E989, ASTM E966, ASTM E1332, BB93, DIN 4109, Document E, GB/T 19889, ISO 16283, ISO 140, ISO 717, ISO 10140, NEN 5077:2019, SIA 181:2006, SIA 181:2020
<p>Room Acoustics Reporter (optional)</p>	<ul style="list-style-type: none"> • Frequency response spectrum and Noise Curves • Room acoustic simulation according to Sabine or Eyring • Import of own sound absorber database and tolerances • Standards GB 50371, IEC 61260, ANSI/ASA S12.2-2019, DIN 15996:2020, ISO R 1996-1971, ASR A3.7:2021, DIN 18041:2016, ISO 3382-1:2009, ISO 3382-2:2008, ÖNORM B 8115-3:2015, ASTM C423-17, ISO 354:2003

Sound Power Reporter (optional)	<ul style="list-style-type: none"> • Enables the import of RTA and reverberation time measurement data in 1/1 and 1/3 octave band resolution into the Sound Power Reporter software • Software provides all the standard reports for sound power measurements • Standards ISO 3741, ISO 3744, ISO 3746, ANSI-ASA S12.51, S12.54, S12.56
---------------------------------	--

Acoustic Analyzer	
FFT Analysis	<ul style="list-style-type: none"> • Real-time FFT with actual level, L_{eq}, L_{min}, L_{max} • Level resolution: 0.1 dB • Frequency Band Ranges: 7 Hz - 215 Hz, 58 Hz - 1.72 kHz, 484 Hz - 20.5 kHz with 143 frequency bins shown on display • Measurement Units: Volt, dBu, dBV and dB SPL • Optional with Extended Acoustic Pack or Spectral Limits: High-resolution Zoom-FFT with selectable frequency ranges and resolution up to 0.4 Hz in the range of 5 Hz to 20 kHz • Optional with Spectral Limits: Capture and tolerance function with multiple readings for comparative measurements and passed/failed analysis
Reverberation Time RT60	<ul style="list-style-type: none"> • Conforms with ISO 3382 and ASTM E2235 • 1/1 octave bands results from 63 Hz - 8 kHz, based on T20 and T30 • Optional with Extended Acoustic Pack: 1/3 octave bands results from 50 Hz - 10 kHz based on T20 and T30 • Range: 10 ms - 30 seconds • Minimum reverberation time (typical) <ul style="list-style-type: none"> » < 100 Hz: 0.3 second » 100 - 200 Hz: 0.2 second » > 200 Hz: 0.1 second • Measurement based Schroeder-method • Test signal: Impulse source or interrupted pink noise generated by the MR-PRO, MR2 or the included NTi Audio Test CD / USB Flash Drive

Polarity	<ul style="list-style-type: none"> • Checks polarity of speakers and line signals • Positive/Negative detection of wideband and individual 1/1 octave bands through internal microphone or XLR/RCA connector • Test signal: NTi Audio polarity test signal generated by the MR-PRO, MR2 or the included NTi Audio Test CD / USB Flash Drive
Delay Time	<ul style="list-style-type: none"> • Propagation delay between electrical reference signal and acoustic signal using the internal microphone • Range: 0 ms - 1 second (0 m - 344 m) • Resolution: 0.1 ms • Test signal: NTi Audio delay test signal generated by the MR-PRO, MR2 or the included NTi Audio Test CD / USB Flash Drive
Noise Curves	<ul style="list-style-type: none"> • Noise Rating NR according to ISO/R 1996-1971 • Noise Criteria NC in accordance with ANSI S12.2-2019 and -1995 • Room Noise Criteria RNC in accordance with ANSI S12.2-2019 • Room Criteria RC in accordance with ANSI S12.2-1995 • Preferred Noise Criteria in accordance with ASA 1971 • Application range of measurement microphones: <ul style="list-style-type: none"> » M2230: down to NC15 » M2340: down to NC15 » M2211: down to NC20 » M4261: down to NC25

1/12 Octave Analysis (optional)	<ul style="list-style-type: none"> • Actual level, Lmin, Lmax, Leq, Leq1; Leq4" • Selectable 1/1, 1/3, 1/6 and 1/12 octave spectral resolution • Measurement Units: Volt, dBu, dBV and dBSPL • Band pass filters (base 10) • Capturing of multiple readings into the internal memory • Comparing measurement results against captures with relative or absolute curve display • Comprehensive tolerance handling • Creating tolerance masks based on captures for passed/failed measurements
Cinema Meter (optional)	<ul style="list-style-type: none"> • Measurements in 1/3 octave resolution in accordance with SMPTE ST 202:2010 and SMPTE RP 200:2012 • An interactive assistant guides the user through dedicated measurement procedures. • Consists of <ul style="list-style-type: none"> » Spectral Limits Option NTi Audio # 600 000 376 » Cinema Assistant Option NTi Audio # 600 000 378

<p>STIPA Speech Intelligibility (optional)</p>	<ul style="list-style-type: none"> • Measurement in accordance with the standards <ul style="list-style-type: none"> » IEC 60268-16 (edition 2, 3, 4 or 5) » AS 1670.4 » BS 5839-8 » CEN/TS 54-32:2015 » DIN EN 50849:2017 » ISO 7240-16 » ISO 7240-19:2007 » DIN VDE 0833-4 » VDE V 0833-4-32:2016 » VDE 0828-1:2017-11 » NFPA 72 » UFC 4-021-01 • Direct measurement method (IEC 60268-16) • Frequency range: 125 Hz - 8 kHz in octave band • Modulation frequencies 0.63 Hz - 12.5 Hz in third-octave resolution <ul style="list-style-type: none"> • Single value STI and CIS test result • Ambient noise correction • Automated averaging of measurements • Modulation indices and individual band level results with error indicator • Test signal: NTi Audio STIPA signal generated by the MR-PRO, NTi Audio TalkBox or other audio players (download wav-file at https://my.nti-audio.com/support/XL2-TA)
--	--

Audio Analyzer	
Conforms with Standards	<ul style="list-style-type: none"> • IEC 61672, IEC 60651, IEC 60804 • DIN EN 60065, VDE 0860, IEC 468-4
Level RMS	<ul style="list-style-type: none"> • True RMS detection in V, dBu, dBV, dBSPL (dBSPL not available for XL2-TA) • Power measurement in Watt W or dBm with flexible load setting from 1.0 to 9999 Ohm • Range XLR/RCA input: 2 μV - 25 V (-112 dBu to +30 dBu) • Accuracy: $\pm 0.5\%$ @ 1 kHz, • Flatness: ± 0.1 dB @ 12 Hz to 21.3 kHz • Bandwidth (-3 dB): 5 Hz to 23.6 kHz • Resolution: 3 digits (dB scale), 5 digits (linear scale) or 6 digits (x1 scale)
Real-Time Analyzer RTA	<p>Following measurement functions offer audio spectrum in Volt, dBu and dBV</p> <ul style="list-style-type: none"> • Sound Level Meter • FFT • 1/12 Octave (optional with Spectral Limits)
Frequency	<ul style="list-style-type: none"> • Range: 9 Hz to 21.3 kHz • Resolution: 6 digits • Accuracy: $< \pm 0.003\%$
THD+N (Total Harmonic Distortion + Noise)	<ul style="list-style-type: none"> • Range: -100 dB to 0 dB (0.001% to 100%) • Minimum level: > -90 dBu • Fundamental frequency range: 10 Hz to 21.3 kHz • Measurement bandwidth: 2 Hz to 23.6 kHz • Resolution: 3 digits (dB scale) or 4 digits (linear scale) • Residual THD+N @ XLR/RCA input: $< 2 \mu$V
Scope	Auto ranging, auto scaling

Filter	<ul style="list-style-type: none"> • Frequency weighting: A, C, Z • Highpass 100Hz, 400 Hz, 19 kHz, • Bandpass 22.4 Hz - 22.4 kHz in accordance with IEC468-4
Remote Measurement (optional)	<p>Querying measurement data online via the USB interface of the following functions:</p> <ul style="list-style-type: none"> • Sound level meter and spectrum analyzer SLMeter/RTA • FFT analyzer • RT60 reverberation time • Audio analyzer RMS/THD+N • High-resolution spectral analyzer 1/12 Oct + Tol

Calibration	
Free-field Correction	<ul style="list-style-type: none"> • NTi Audio Class 1 Sound Calibrator <ul style="list-style-type: none"> » M2230: -0.1 dB » M2340: -0.1 dB » M2211: -0.1 dB » M2215: -0.1 dB • NTi Audio Class 1 Sound Calibrator with 1/4" Calibration Adapter, type ADP 1/4-P <ul style="list-style-type: none"> » M4260: +0.1 dB » M4261: +0.2 dB
Wind Screen Correction	<ul style="list-style-type: none"> • 50 mm Wind Screen: +0,12 dB • 90 mm Wind Screen: +0,19 dB • WP30/WP61 Wind Screen 90 mm: +0,19 dB

Calibration	<ul style="list-style-type: none"> • Recommended calibration interval: one year • Microphone calibration with external calibrator supported • Optional calibration certificate for new instruments available
-------------	---

Vibration Meter	
Channels	<ul style="list-style-type: none"> • 1 (Single-channel)
Parameters	<ul style="list-style-type: none"> • Real time measurement in <ul style="list-style-type: none"> » Acceleration: m/s², g, in/s², dB » Velocity: m/s, in/s, dB » Displacement: m, in, dB » Peak particle velocity PPV: mm/s, in/s » Levels: RMS, Peak, Peak-Peak
VibMeter	<ul style="list-style-type: none"> • Broadband level <ul style="list-style-type: none"> » Frequency range: 0.8 Hz - 2.5 kHz • Spectral <ul style="list-style-type: none"> » 1/1 octave band display: 1 Hz - 2.0 kHz <ul style="list-style-type: none"> sub ranges 1 Hz - 500 Hz or 4 Hz - 2 kHz » 1/3 octave band display: 0.8 Hz - 2.5 kHz <ul style="list-style-type: none"> sub ranges 0.8 Hz - 1.0 kHz, 2.5 Hz - 2.5 kHz » Broadband level measured with bandwidth (- 3dB): 0.7 Hz – 23.6 kHz • Display according to DIN 45669-1:2010 <ul style="list-style-type: none"> » Unweighted velocity v(t) » Maximum absolute velocity v _{max} » Averaging duration T_m » Measurement duration T_M

Filter	<ul style="list-style-type: none"> • Flat (no filter) Bandwidth (- 3dB): 0.7 Hz – 23.6 kHz • 10 - 1000 Hz according to ISO 2954 with decay rate = 18 dB / octave • 1 - 80 Hz, 1 - 315 Hz acc. to DIN 45669-1:2010 with decay rate = 12 dB / octave
Audio Recording in VibMeter	<ul style="list-style-type: none"> • Default <ul style="list-style-type: none"> » Recording of compressed wav-files (ADPCM - 4 bit, 24 kHz) » a new wav-file starts every 12 hours (max. wav-file size 512 MB) » Bandwidth: 2.0 Hz - 10.2 kHz • Optional: Extended Acoustic Pack <ul style="list-style-type: none"> » Recording of linear wav-files (24 bit, 48 kHz) » a new wav-file starts every 1 hours (max. wav-file size 512 MB) » Bandwidth: 2.0 Hz - 23.6 kHz
FFT Analysis	<ul style="list-style-type: none"> • Frequency range: 1 Hz - 1.69 kHz • Optional with Extended Acoustic Pack or Spectral Limits: High-resolution Zoom-FFT with selectable frequency ranges and resolution up to 0.4 Hz in the range of 1 Hz to 20 kHz
1/12 Octave Analysis (optional)	<ul style="list-style-type: none"> • Actual level, L_{min}, L_{max}, Leq, $Leq1$, $Leq4$ • Selectable 1/1, 1/3, 1/6 and 1/12 octave spectral resolution • Measurement Units <ul style="list-style-type: none"> » Acceleration: m/s², g, in/s², dB » Velocity: m/s, in/s, dB » Displacement: m, in, dB • Band pass filters (base 10) • Frequency range: 0.73 Hz - 1.36 kHz

Maximum Input Level	<ul style="list-style-type: none"> • 353 m/s², 36 g @ 20 mV/(m/s²) with ICP Adapter ASD
Residual Noise (typical) with ICP Adapter ASD	<ul style="list-style-type: none"> • 17 μV @ 0.7 Hz ... 23.0 kHz • 14 μV @ 1 Hz ... 315 Hz • 14 μV @ 1 Hz ... 80 Hz
Reference-measurement range	<ul style="list-style-type: none"> • Mid

Input / Output Interfaces	
Audio Inputs	<ul style="list-style-type: none"> • XLR balanced <ul style="list-style-type: none"> » Input impedance = 200 kOhm » Phantom power: +48 VDC switchable with maximum 10 mA supply current in accordance with IEC 61938 » Automated sensor detection for NTi Audio's ASD measurement microphones and pre-amplifiers • RCA unbalanced with input impedance >30 kOhm • Built-in condenser microphone for polarity testing, delay measurements and voice note recording
Audio Outputs	<ul style="list-style-type: none"> • Built-in speaker • Headphone connector <ul style="list-style-type: none"> » 3.5 mm Minijack » mono monitor wired to both channels of stereo jack » Linear output signal over a measurement range of 57 dB in SLMeter measurement function » Maximum output level: 0.33 Vrms / 0.47 Vp
USB Interface	USB mini connector for data transfer to PC, XL2 Projector PRO and/or charging of Li-Po battery
Digital I/O	Connection interface to accessories <ul style="list-style-type: none"> • XL2 Input Keypad • Limit Light • Stack Light • Digital I/O Adapter PCB
TOSLink	24 bit linear PCM audio signal output (prepared for later firmware extension)

Memory	<p>SD Card included (8 GByte), removable, storing measurement data in ASCII format, screen shots, voice notes and wav-files</p> <p>Data logging every second offers following noise monitoring periods:</p> <ul style="list-style-type: none"> • Logging default noise levels: > 2 years • Additional logging of 1/3 octave data: > 6 month • Additional <ul style="list-style-type: none"> » compressed audio recording: > 1 week » linear audio recording: > 15 hours <p>Optional 32 GB SD-cards are available for longer monitoring requirements; requires XL2-TA Firmware V4.10 or higher.</p>
Power Supply	<ul style="list-style-type: none"> • Rechargeable Li-Po battery included <ul style="list-style-type: none"> » Type 3.7 V / 2260 mAh » Typical battery lifetime > 4 hours » Range: 3.3 - 4.5 VDC » Volume energy density = 339 Wh/l • Dry cell batteries type AA, 4 x 1.5 V <ul style="list-style-type: none"> » Typical battery lifetime > 4 hours » Range: 3.7 - 6.0 VDC • Linear external power supply 9 VDC <ul style="list-style-type: none"> » Range: 7.5 - 20.0 VDC @ minimum 6 Watt » Charges Li-Po battery during operation » Connector C5.5 x 2.1 x 12 mm • USB-Power Supply <ul style="list-style-type: none"> » for short-term operation < 1 day » charging power is equal or less than power consumption

Power Supply	<ul style="list-style-type: none"> • External battery pack <ul style="list-style-type: none"> » 22 Ah battery pack: 4 days » 44 Ah battery pack: 8 days
--------------	---

General

Clock	<ul style="list-style-type: none"> • Default <ul style="list-style-type: none"> » Real-time clock with lithium backup battery » Typical life backup battery: 8 years » Return instrument for battery replacement » Drift < 1.7 seconds per 24 hours • Special XL2-TA edition, NTi Audio # 600 000 356 <ul style="list-style-type: none"> » VCXTO clock » Drift < 0.04 seconds per 24 hours
Mechanics	<ul style="list-style-type: none"> • Tripod or microphone stand mount 1/4" • Wire stand mounted on rear side • Display: 160 x 160 pixels grey scale with LED back light • Dimensions (L x W x H) <ul style="list-style-type: none"> » 180 mm x 90 mm x 45 mm » 7.1" x 3.5" x 1.8" • Weight: 480 g (1 lb) including built-in Li-Po battery
Temperature	-10 °C to +50 °C (14° to 122°F)
Humidity	5% to 90% RH, non-condensing
Static air pressure	65 kPa to 108 kPa
Susceptibility to radio frequencies	Classification Group X

Electromagnetic Compatibility	CE compliant: EN 61326-1 Class B, EN 55011 class B EN 61000-4-2 to -6 & -11
Protection Rating	IP51
ATEX	<ul style="list-style-type: none"> • For applications in explosive atmospheres within zone 2 in accordance with IEC 60079 • Directive 2014/34/EU

24. Technical Data Microphones

	M2230	M2340 (with self-test)	M2211	M2215 (high levels)	M4261
Classification with XL2-TA according to IEC 61672, ANSI S1.4	Class 1 certified	Class 1 certified	Frequency Response Class 1		Class 2
Consisting of	PreAmplifier MA220 + MC230 or MC230A Capsule	PreAmplifier MA230 + MC230A Capsule	PreAmplifier MA220 + Capsule 7052	PreAmplifier MA220 + Capsule 7056	M4261 microphone with permanently installed capsule
Microphone Type	Omnidirectional, pre-polarized condenser, free field microphone				
Capsule / Transducer	1/2" detachable with 60UNS2 thread, type WS2F according IEC 61094-4				1/4" permanently installed
PreAmplifier Type	MA220	MA230	MA220		-
System Self-test (CIC)	-	with XL2-TA	-		
Flatness tolerance bands typical	± 1 dB @ 5 Hz - 20 Hz ± 1 dB @ >20 Hz - 4 kHz ± 1.5 dB @ >4 kHz - 10 kHz ± 2 dB @ >10 kHz - 16 kHz ± 3 dB @ >16 kHz - 20 kHz				$+1/-4.5$ dB @ 5 Hz - 20 Hz ± 1.5 dB @ >20 Hz - 4 kHz ± 3 dB @ >4 kHz - 10 kHz ± 4.5 dB @ >10 kHz - 16 kHz ± 5 dB @ >16 kHz - 20 kHz
Actual Frequency Response	freely available as Excel-data, register product at https://my.nti-audio.com and contact info@nti-audio.com				
Frequency Range	5 Hz - 20 kHz				
Residual Noise Floor typical	16 dB(A)	17dB(A)	21 dB(A)	25 dB(A)	27 dB(A)
Maximum SPL @ THD 3%, 1 kHz, S_typical	137 dB SPL	138 dB SPL	144 dB SPL	153 dB SPL	142 dB SPL

	M2230	M2340 (with self-test)	M2211	M2215 (high levels)	M4261
Sensitivity typical @ 1 kHz	-27.5 dBV/Pa ±2 dB (42 mV/Pa)		-34 dBV/Pa ±3 dB (20 mV/Pa)	-42 dBV/Pa ±3 dB (8 mV/Pa)	-36 dBV/Pa ±4 dB (16 mV/Pa)
Temperature Coefficient	< -0.01 dB / °C		< ±0.015 dB / °C		< ±0.02 dB / °C
Temperature Range	-10°C to +50°C (14°F to 122°F)				0°C to +40°C (32°F to 104°F)
Pressure Coefficient	-0.005 dB / kPa		-0.02 dB / kPa		-0.04 dB / kPa
Influence of Humidity (non-condensing)	< ±0.05 dB				< ±0.4 dB
Humidity	5% to 90% RH, non-condensing				
Long-term Stability	> 250 years / dB				-
Power Supply	48 VDC phantom power				
Current Consumption typical	2.3 mA	0.8 mA	2.3 mA		1.7 mA
Electronic Data Sheet	NTi Audio ASD in accordance with IEEE P1451.4 V1.0, Class 2, Template 27				
Output Impedance	100 Ohm balanced				
Connector	Balanced 3-pole XLR				
Diameter Dimensions	20.5 mm (0.8")				
Length Dimensions	154 mm (6.1")		150 mm (5.9")		
Weight	100 g (3.53 oz)				83 g (2.93 oz)
Environmental Protection	IP51				
Windscreen Diameter	50 mm (2")	90 mm (3.5")	33 mm (1.3")	33 mm (1.3")	33 mm (1.3")
Scope of Supply	Windscreen, Microphone Holder with Adapter 5/8" - 3/8", Manual				
NTi Audio #	600 040 050	600 040 230	600 040 022	600 040 045	600 040 070

Outdoor Measurement Microphones

	M2230-WP (M2230+WP30)	M2340-WP (M2340+WP30)	M4261-WP (M4261+WP61)
Classification with XL2-TA according to IEC 61672, ANSI S1.4	Class 1 certified	Class 1 certified	Class 2
System Self-test (CIC)	-	with XL2-TA	-
Windscreen Diameter	90 mm (3.5")		
Diameter Dimensions	36 mm (1.4")	36 mm (1.4")	36 mm (1.4")
Length Dimensions	378 mm (14.9")	378 mm (14.9")	378 mm (14.9")
Weight	430 g, 15.17 oz	430 g, 15.17 oz	413 g, 14.57 oz
Environmental Protection	IP54 in vertical position	IP54 in vertical position	IP54 in vertical position
Mounting	Standard 3/8" tripod mount included		
Optional Pole Mount Adapter	<ul style="list-style-type: none"> • Pole Mount Adapter PM 1" • Pole Mount Adapter PM 1 1/4" 	<ul style="list-style-type: none"> for pole diameter 25 - 33 mm (1-1.3") for pole diameter 32 - 44 mm (1.25-1.75") 	<ul style="list-style-type: none"> NTi Audio # 600 040 067 NTi Audio # 600 040 068
NTi Audio #	600 040 050 + 600 040 060	600 040 230 + 600 040 060	600 040 070 + 600 040 080

Typical Frequency Response of Measurement Microphones

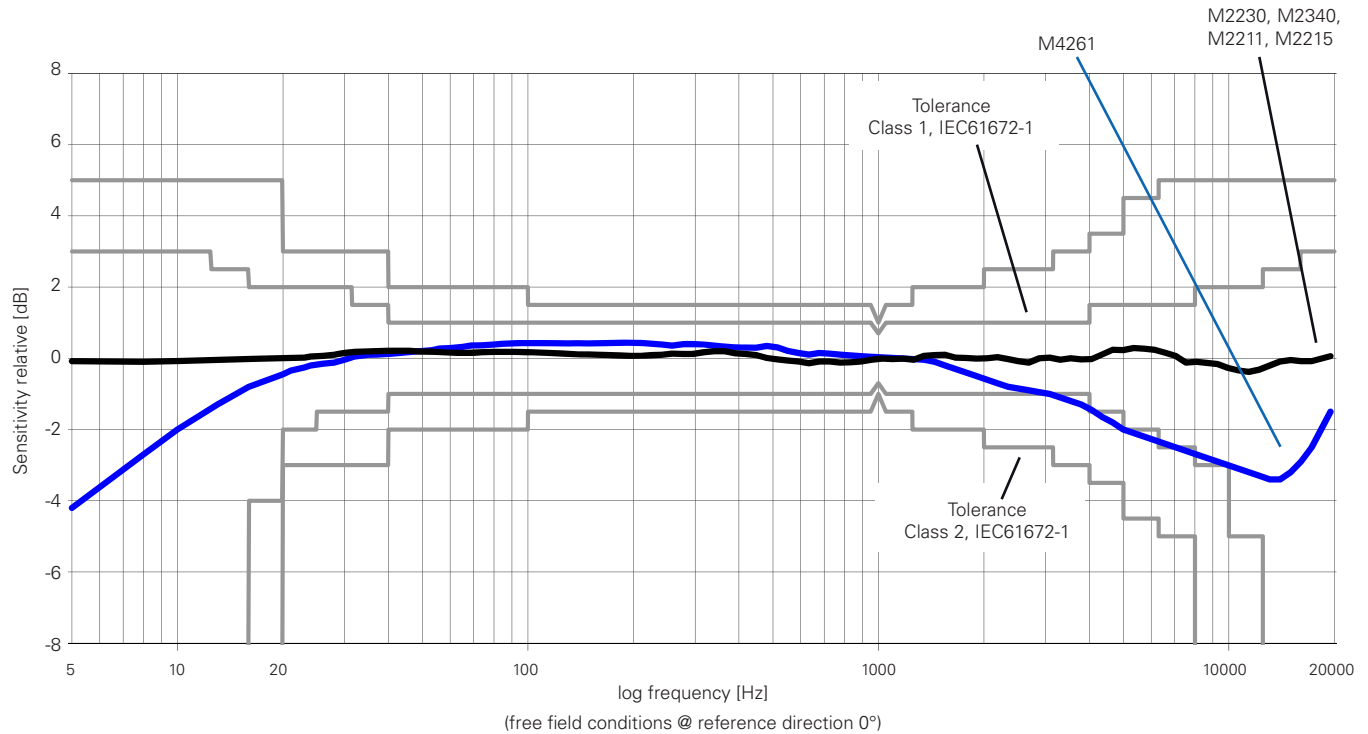

Linear Measurement Range
acc. IEC61672 / ANSI S1.4
(typ. microphone sensitivity)

XL2-TA + M2230: 24 dB(A) - 137 dB

XL2-TA + M2340: 25 dB(A) - 138 dB

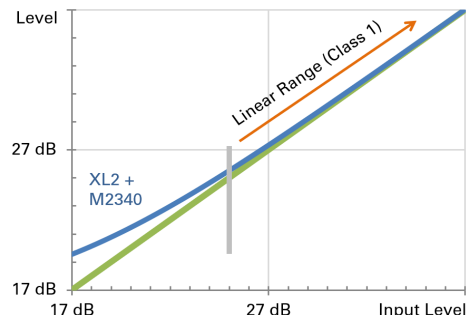
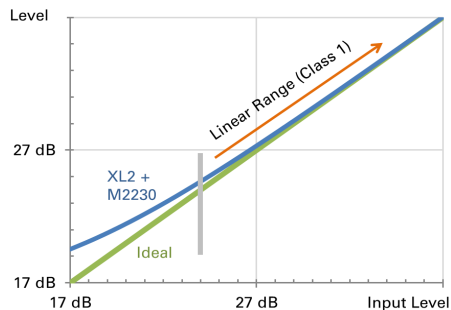

XL2-TA + M2211: 29 dB(A) - 144 dB

XL2-TA + M4261: 33 dB(A) - 146 dB

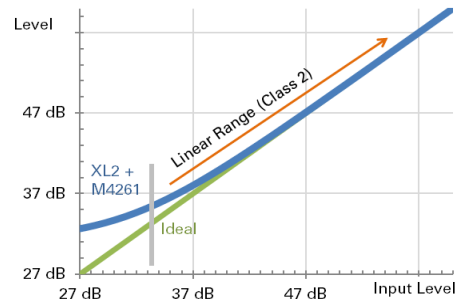
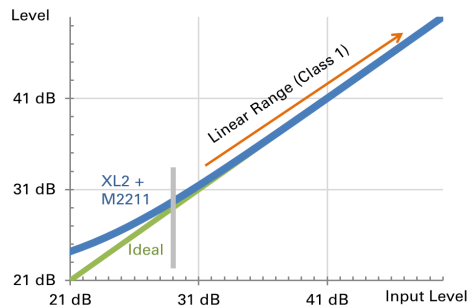

Free Field - Pressure Correction Factors

If a measurement microphone is held in a free-field environment, then the measurement microphone acts at high frequencies like a reflector. The sound pressure increases in front of the microphone capsule membrane. M2230, M2340, M2211 and M2215 are free-field equalized measurement microphones, they compensate for the increased pressure internally. The calibration of the measurement microphones M2230 and M2340 with the B&K 4226 requires the accessory Adapter Ring MXR01, NTi Audio # 600 040 105. Please note, never touch the diaphragm of the measurement microphone capsule.

The calibrator no longer offers free-field conditions. Therefore, the free-field equalization of the microphone must be compensated. This needs to be considered prior the calibration. The correction value needs to be added to the pressure response of the microphone.

Example:

- During the calibration, the XL2-TA measures the sound level in the calibrator. If the B&K 4226 calibrator is used and it is set to 16 kHz, then the XL2-TA+M2230 reads just 86.7 dBA.
- The free-field sound level is calculated by summing the XL2-TA measurement value and the correction value (86.7 dB + 7.3 dB = 94.0 dB).

The following corrections apply with the B&K 4226 calibrator:

Nominal Frequency [Hz]	M2230, M2340 with MXR01 Adapter [dB]	M2230, M2340 [dB]	M2211 [dB]	M2215 [dB]	Measurement Uncertainty U [dB]
31.5	-0.3	0.0	-0.2	0.0	0.3
63	0.0	0.0	0.0	0.0	0.3
125	-0.2	0.0	-0.1	-0.1	0.3
250	-0.2	0.0	-0.1	-0.1	0.3
500	-0.2	0.0	-0.1	-0.1	0.3
1000	0.0	0.0	0.0	0.0	0.3
2000	0.1	0.3	0.1	0.0	0.3
4000	0.7	0.7	0.7	0.4	0.3
8000	2.7	2.6	4.5	4.7	0.4
12500	7.2	6.0	5.8	6.1	0.7
16000	7.3	7.3	7.9	7.9	0.8

Correction values for other calibrators for M2230 and M2340:

Type	Correction Value	Calibration Frequency	Calibration Level
NTi Audio CAL200	-0.1	1 kHz	114 dB
B&K 4231	-0.2	1 kHz	114 dB
Norsonic Nor-1251	-0.2	1 kHz	114 dB

Actuator Correction

The following free-field 0° incidence corrections apply for calibration using a protection grid actuator (e.g. B&K UA033, GRAS RA0014). Please note, never touch the diaphragm of the measurement microphone capsule. The maximum DC bias for the actuator calibration is 200 VDC.

M2211, M2215

Nominal Frequency [Hz]	M2211 [dB]	M2215 [dB]
31.5	0.0	0.0
63	0.0	0.0
125	0.0	0.0
250	0.0	0.0
500	0.1	0.0
1000	0.1	0.0
2000	0.6	0.2
4000	1.7	1.2
8000	4.2	3.9
12500	7.3	6.7
16000	9.2	9.0

M2230, M2340

The calibration requires the accessory Actuator Grid, NTi Audio # 600 040 112. The Actuator Grid comes with an insulation ring dedicated for this measurement method.

Nominal Frequency [Hz]	M2230, M2340 [dB]
<400	0.0
400	-0.2
500	0.0
630	-0.2
800	0.0
1000	0.0
1250	-0.1
1600	0.2
2000	0.2
2500	0.3
3150	0.8
4000	1.0
5000	1.6
6300	2.4
8000	3.6
10000	4.8
12500	6.5
16000	9.3
20000	11.7

Diffuse-field Sensitivity Level Correction

A diffuse sound field is characterized by the sound arriving at the receiver from all directions with more or less equal probability. The M2230, M2340, M2211, M2215 and M4261 are free-field equalized measurement microphones. The default frequency response refers to a 0° sound incidence. The diffuse-field sensitivity level correction is calculated by averaging the directional characteristics in accordance with IEC 61183. The corrections for diffuse-field conditions are documented in the following table and may be activated directly on the XL2-TA; see Spectral Corrections. The directional response of the M2230 is described in the appendix.

Example:

- The sound pressure level in a diffuse sound field shall be determined. The display of the XL2-TA with the M2230 reads 80.0 dBA for the 20 kHz third-octave band.
- The diffuse sound level is now calculated from the sum of the XL2-TA measurement value and the correction value (80.0 dB + 5.9 dB = 85.9 dB).



The diffuse-field sensitivity level correction is not necessary using a diffuse field equalized measurement microphone.

Nominal Frequency [Hz]	1/2" Microphone M2230, M2340, M2211, M2215 [dB]	1/4" Microphone M4261 [dB]
<63	0.0	0.0
63	0.0	0.0
80	0.0	0.0
100	0.0	0.0
125	0.0	0.0
160	0.0	0.0
200	0.0	0.0
250	0.0	0.0
315	0.0	0.0
400	0.0	0.0
500	0.0	0.0
630	0.0	0.0
800	0.0	0.0
1000	0.0	0.0
1250	0.1	0.1
1600	0.2	0.1
2000	0.2	0.1
2500	0.4	0.2
3150	0.6	0.3
4000	0.8	0.3
5000	1.3	0.5
6300	1.8	0.8
8000	2.5	1.1
10000	3.4	1.6
12500	4.4	2.2
16000	5.3	2.8
20000	5.9	3.4

Free-field and Diffuse-Field Sensitivity for M2230 and M2340

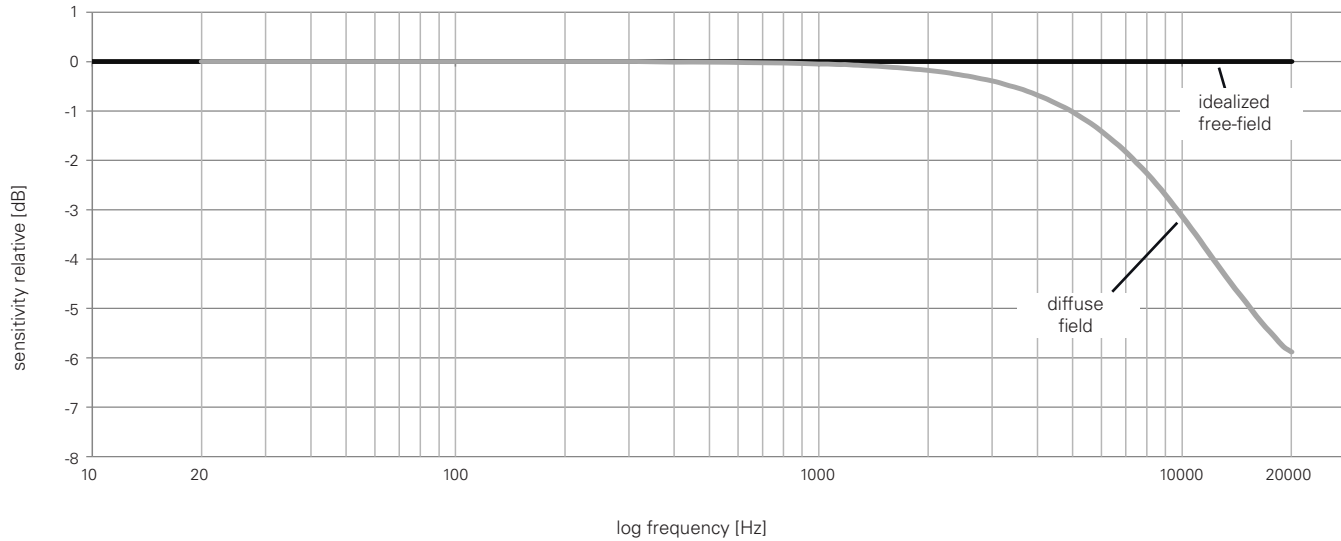

Spectral Correction for horizontal Sound Incidents using the Outdoor Microphone

The outdoor measurement microphone fulfills the requirements of IEC 61672 and ANSI S1.4 for vertical sound incidence. For compliance with horizontal sound incidence a spectral correction is employed in the associated XL2-TA Sound Level Meter.

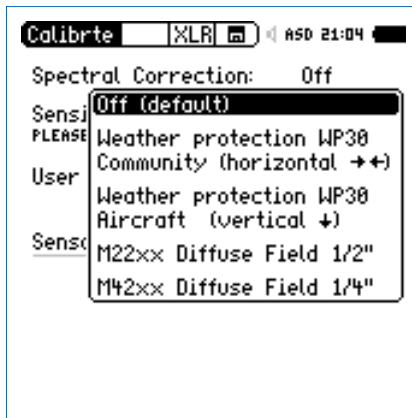

the **Calibration** menu.

Spectral Correction for horizontal sound incidents:

Nominal Frequency [Hz]	WP30 Weather Protection [dB]		WP61 Weather Protection [dB]	
	1/3 Octave	1/1 Octave	1/3 Octave	1/1 Octave
<800	0.0	0.0	0.0	0.0
800	0.0		0.0	
1000	0.0	0.0	0.0	0.0
1250	0.1		0.0	
1600	0.2		0.2	
2000	0.3	0.4	0.3	0.4
2500	0.7		0.8	
3150	1.3		1.4	
4000	2.0	2.0	2.1	2.0
5000	2.7		2.5	
6300	2.9		2.3	
8000	3.3	3.4	2.4	2.5
10000	3.9		2.8	
12500	4.6		3.0	
16000	6.4	5.9	3.1	3.0
20000	6.8		3.1	

Select **Calibrate Menu: Show Spec Correction** in the **System Settings**. This will enable the spectral correction field in

25. Technical Data PreAmplifier

	MA220 PreAmplifier	MA230 PreAmplifier with self-test (CIC)
Microphone PreAmplifier	Compatible with 1/2" microphone capsules type WS2F in accordance with IEC61094-4	
Frequency Range (-3dB)	4 Hz - 100 kHz	1.3 Hz - 50 kHz
Residual Noise Floor typical	1.9 μ V(A) at C_in 15 pF \pm 5.6 dBA @ 42 mV/Pa	2.4 μ V(A) at C_in 15 pF \pm 9.1 dBA @ 42 mV/Pa
Frequency Response Flatness	\pm 0.2 dB	\pm 0.1 dB, 10 Hz - 20 kHz
Phase Linearity	< 1° @ 20 Hz - 20 kHz	
Maximum Output Voltage @ THD 3%, 1 kHz	21 Vpp \pm 7,4 Vrms \pm 138,9 dBSPL @ 42 mV/Pa	22 Vpp \pm 7,8 Vrms \pm 139,3 dBSPL @ 42 mV/Pa
Electronic Data Sheet	Containing user calibration data; default factory sensitivity = 4.9 V/Pa Read/write by XL2-TA Audio and Acoustic Analyzer NTi Audio ASD in accordance with IEEE P1451.4 V1.0, Class 2, Template 27	
Impedance	Input: 20 GOhm // 0.26 pF, Output: 100 Ohm balanced	
Power Supply	48 VDC phantom power, 2.3 mA typical	48 VDC phantom power, 0.8 mA typical
Attenuation	< 0.17 dB (Rphantom 2x 6.8 kOhm)	< 0.07 dB (Rphantom 2x 6.8 kOhm)
Connector	Balanced 3-pole XLR	
Thread for Capsule	60 UNS2	
Weight	90 g, 3.17 oz	
Dimensions	Length 142.5 mm (5.6"), diameter 20.5 mm (0.8")	
Temperature Range	-10°C to +50°C (14°F to 122°F)	
Humidity	5% to 90% RH, non-condensing	
NTi Audio #	600 040 040	600 040 200

The product specifications may vary based on the mounted microphone capsule type.

Appendix

Appendix 1: Standard - Optional Features

	Standard Features	Optional
Sound Level Meter Frequency Weighting	A C Z	-
Sound Level Meter Time weighting	F S EQ EQ_T PK	<ul style="list-style-type: none"> Extended Acoustic Pack: <ul style="list-style-type: none"> I Impulse E Sound Exposure Level <p>Percentile Sound Pressure Levels for wide band, 1/1 and 1/3 octave spectrum with flexible setting from 0.1% to 99.9%.</p>
Sound Level Meter Correction	K1 K2 off	-

	Standard Features	Optional
Sound Level Meter Parameter	<div style="display: flex; gap: 10px;"> Live max min Prev </div>	<ul style="list-style-type: none"> Extended Acoustic Pack: Clock-Impulse Maximum Level (Taktmaximalpegel) in accordance with DIN 45645-1: <div style="display: flex; gap: 10px; margin-top: 10px;"> T3 T3eq T5 T5eq </div> <p>Calculated levels in accordance with DIN 45645-1: L_{AFT5eq}-L_{Aeq} L_{AIeq}-L_{Aeq} L_{Ceq}-L_{Aeq}</p> <p>Impulsiveness in accordance with BS4142:2014 and NordTest ACOU 112 ImpPenalty ImpPen_max</p>
Sound Level Meter RTA Spectrum Analyzer	supported	<ul style="list-style-type: none"> Extended Acoustic Pack or Spectral Limits Option: True peak level PK

	Standard Features	Optional
Sound Level Meter Audio Recording	<ul style="list-style-type: none"> Recording of wav-files (ADPCM compression) Voice note recording 	<ul style="list-style-type: none"> Extended Acoustic Pack: Recording of wav-files (24 bit, 48 kHz)
Sound Level Meter Triggered Event Recording	-	<ul style="list-style-type: none"> Extended Acoustic Pack: Evt
Sound Level Meter Logging	supported	<ul style="list-style-type: none"> 100 ms logging RTA logging of Lmin and Lmax
FFT Analysis Measurement Range	200 1k7 20k	<ul style="list-style-type: none"> Extended Acoustic Pack or Spectral Limits Option: Usr with zoom function
FFT + Tol Capture and Tolerance	-	<ul style="list-style-type: none"> Spectral Limits: Capture and Tolerance functionality
RT60	Octave band resolution	<ul style="list-style-type: none"> Extended Acoustic Pack: 1/3 octave band results
1/12 Oct + Tol	-	<ul style="list-style-type: none"> Spectral Limits: 1/12 Oct + Tol Capture and Tolerance functionality

	Standard Features	Optional
Noise Curves	-	<ul style="list-style-type: none"> • Spectral Limits Option
STIPA	-	<ul style="list-style-type: none"> • STIPA Option with STIPA functionality
Cinema Meter	-	<ul style="list-style-type: none"> • Cinema Meter Option
Querying measurement data online via the USB interface	-	Remote Measurement Option supporting <ul style="list-style-type: none"> • Sound level meter and spectrum analyzer SLMeter/RTA • FFT analyzer • RT60 reverberation time • Audio analyzer RMS/THD+N • High-resolution spectral analyzer 1/12 Oct + Tol

Appendix 2: Factory Default Profiles

You may start up the XL2-TA with individual preset application profiles.

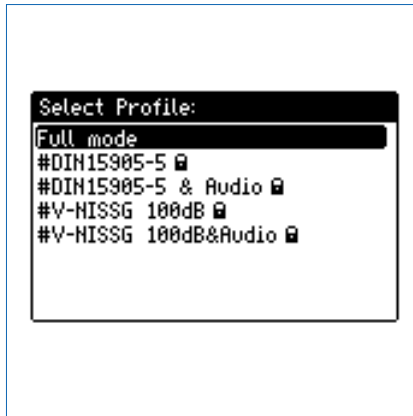

The profile **Full mode** is the default configuration with all available measurement functions enabled.

DIN15905-5 / DIN15905-5 & Audio (Sound Level Monitoring in accordance with DIN15905-5)

The following limits apply at all areas accessible by the visitors during the measurement period of 30 minutes:

- Maximum averaged level = 99 dB
The XL2-TA displays this maximum level with the measurement result L_{Aeq+k1} .
- Maximum peak level L_{Cpeak} = 135 dB

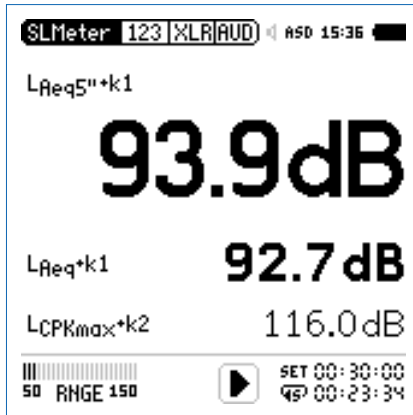



These levels are shown in the numeric result page:

- $L_{Aeq5''+k1}$** Time-averaged sound pressure level L_{Aeq} with correction value $k1$ and a moving time window of 5 seconds.
- L_{Aeq+k1}** Time-averaged sound pressure level L_{Aeq} with correction value $k1$.
- $L_{Cpeak+k2}$** C-weighted peak level L_{Cpeak} with correction value $k2$.

The following sound levels are displayed in the real-time analyzer page:

- $L_{ZFhold3}$** For tracing of feedback frequencies. The peak hold time is set to 3 seconds.
- L_{ZFlive}** Actual real-time spectra.

How to Measure

- Select the page **KSET** with the rotary wheel .
- Measure the correction values k1 and k2 as described in the chapter Sound Level Meter: Correction Value KSET.
- Press the start button .
- The icon **LOG** flashes during the ongoing measurement. In the case where the profile **#DIN15905-5 & Audio** has been selected the icon **AUD** flashes, indicating the additional audio wav-file logging.
- During the measurement you can monitor the actual sound level $L_{Aeq5''+k1}$ in order to remain below the permitted limits; alternatively you may monitor the spectrum analyzer for tracing possible feedback frequencies.
- Press stop  to finish the measurement.



In accordance with DIN15905-5, all sound levels are measured, displayed and logged to the SD Card automatically. The settings are locked, which ensures that the correct parameters are measured.

The profile **#DIN15905-5 & Audio** includes the recording of **Compressed+AGC** wav-files.

Limits

This profile is configured with the following limits, which trigger the lights on the limit button and external Digital I/O Adapter. This facilitates a quick response to sound levels that exceed these limits.

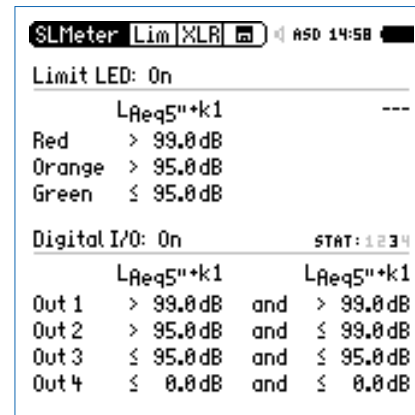

Measurement Results

You may import the log files into a report generator software based on MS Excel, providing automatically-completed live event reports with noise level charts. The report generator software is a free download on the support website at <https://my.nti-audio.com> for all registered XL2-TA customers.

V-NISSG 100dB / V-NISSG 100dB&Audio (Sound Level Monitoring in accordance with V-NISSG)

The following limits apply at all areas accessible by the visitors during the moving measurement period window of 60 minutes during the live event:

- Maximum averaged level
The XL2-TA displays this maximum level with the measurement result $L_{Aeq60'+k1}$.

Type of live event	Max. level	Requirements
3	100 dB	- Sound level recording - Results to store for 30 days - Level warning to visitors - Hearing protection distributed - Chill out zone < 85 dB(A)
2	96 dB	- Sound level monitoring - Level warning to visitors - Hearing protection distributed
1	93 dB	- Sound level monitoring

- Maximum peak level $L_{AFmax} = 125$ dB

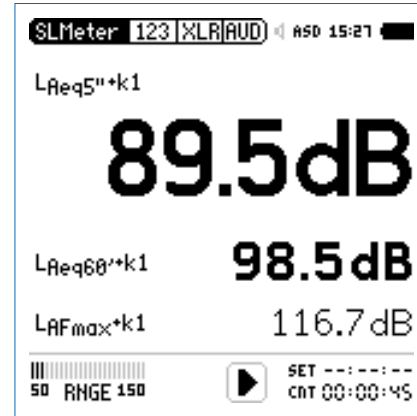

These levels are shown in the numeric result page:

$L_{Aeq5'+k1}$ Time-averaged sound pressure level L_{Aeq} with correction value $k1$ and a moving time window of 5 seconds.



$L_{Aeq60'+k1}$ Time-averaged sound pressure level L_{Aeq} with correction value $k1$ and a moving time window of 60 minutes.

$L_{AFmax+k1}$ Maximum sound pressure level L_{AFmax} with correction value $k1$.

The following sound levels are displayed in the real-time analyzer page:

- LZFhold3** For tracing of feedback frequencies. The peak hold time is set to 3 seconds.
- LZFlive** Actual real-time spectra.

How to Measure

- Select the page KSET with the rotary wheel .
- Measure the correction value k1 as described in the chapter Sound Level Meter: Correction Value KSET. (k2 is not required for V-NISSG)
- Press the start button .
- The icon **LOG** flashes during the ongoing measurement. In the case where the profile **#V-NISSG 100dB&Audio** has been selected the icon **AUD** flashes, indicating the additional audio wav-file logging.
- During the measurement you can monitor the actual sound level $L_{Aeq5} + k1$ in order to remain below the permitted limits; alternatively you may monitor the spectrum analyzer for tracing possible feedback frequencies.
- Press stop  to finish the measurement.



In accordance with V-NISSG, all sound levels are measured, displayed and logged to SD Card automatically. The settings are locked, which ensures that the correct parameters are measured.

The profile **#V-NISSG 100dB&Audio** includes the recording of **Compressed+AGC** wav-files.

Limits

This profile is configured with the following limits, which trigger the lights on the limit button and external Digital I/O Adapter. This facilitates a quick response to sound levels that exceed these limits.

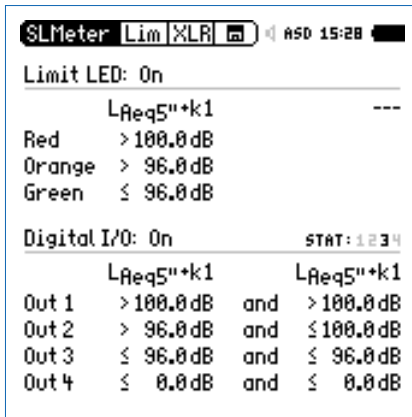

Measurement Results

You may import the log files into a report generator software based on MS Excel, providing automatically-completed live event reports with noise level charts. The report generator software is a free download on the support website at <https://my.nti-audio.com> for all registered XL2-TA customers.

Appendix 3: Description Sound Levels



A-Frequency Weighting Filter in accordance with IEC 61672

Applicable for most common sound pressure level measurements, compensating for human hearing perception at lower sound pressure levels.



C-Frequency Weighting Filter in accordance with IEC 61672

Applicable for very high sound pressure levels, compensating for human hearing perception at high sound pressure levels; typically used for measurement of peak values, e.g. L_{Cpeak}



Capture

This selection offers the reference curve, which has been previously stored with **Capture** in the spectrum analyzer of the SLMeter function.

Application example:

- Comparing the performance of the left and right speakers in a live event sound setup.



Sound Exposure Level

The sound exposure level L_{AE} characterizes the total energy content of a signal and corresponds to the L_{Aeq} normalized to one second. The sound exposure level is measured for example to compare noise events with different time durations. The L_{AE} reports the amount of noise from an event such as an individual aircraft fly-over. An earlier used level name is SEL.

$$L_{AE} = L_{Aeq} + 10 \times \log(\text{time in seconds})$$



Time-Average Sound Level or Equivalent Continuous Sound Level in accordance with IEC 61672



Octave-band Time-Average Sound Level or Equivalent Continuous Sound Level in accordance with IEC 61672

with selectable 63 Hz or 125 Hz octave-band level for low frequency noise monitoring; in case of a selected 1/3 octave resolution in the RTA window, these levels are calculated by summing the corresponding one-third-octave levels.



Moving Time-Average Sound Level or Moving Equivalent Continuous Sound Level

With selectable time window from one second up to one hour, four individual levels can be configured. The moving time-average sound level is a Leq based on a moving time window. This level is also called “running Leq,T ”, “gliding Leq,T ” or “sliding Leq,T ”.

The measurement result is updated every second for the first 60 seconds. Afterwards the update rate is every five seconds. This is an example:

10h 00min 00sec	Start of XL2-TA measurement
10h 00min 05sec	$Leq5'' = Leq$ of the 5 seconds
10h 00min 06sec	$Leq5'' = Leq$ of the time window from 10h 00min 01sec to 10h 00min 06sec
10h 00min 07sec	$Leq5'' = Leq$ of the time window from 10h 00min 02sec to 10h 00min 07sec

Application example:

- Display the moving Leq over 5 seconds in accordance with DIN15905
- Measure the moving Leq over 60 minutes in accordance with V-NISSG

F

Fast Time Weighting

Time constant $t = 125$ ms; the time weighting is an exponential function of time, which defines how changes of the instantaneous sound pressure level are averaged for useful sound pressure level results. The measurement results are shown accurately for sound sources with a minimum length of 0.5 seconds. The decay rate is 34.7 dB/s. Fast time weighting is typically used for common sound level measurements.

Hold

Holding Maximum Level

For tracing of feedback frequencies in the RTA page. The hold time can be set to 3, 5 or 10 seconds.

I

Impulse Time Weighting

Time constant attack $t = 35$ ms; time constant decay $t = 1500$ ms; the time weighting is an exponential function of time, which defines how changes of the instantaneous sound pressure level are averaged for useful sound pressure level results. The measurement results are shown accurately for sound sources with a minimum length of 0.1 seconds. Impulse time weighting is used for impulsive sound sources.

ImpP

Impulse Penalty ImpPenalty

Impulsive penalty in accordance with BS4142:2014 and NordTest ACOU 112. The LAF is sampled with a time interval of 12 ms. The penalty is calculated as follows:

$$\text{Penalty KI} = 1.8 * (\text{Prominence } P - 5) \text{ for } P > 5$$

$$P = 3 * \lg(\text{onset rate}[\text{dB/s}]) + 2 * \lg(\text{level difference}[\text{dB}])$$

The Prominence P is designed to give a maximum around 15; concluding the maximum impulse penalty is 18 dB.

K1**Correction Value k1**

The correction value k1 is based on an LAeq measurement. It is measured or manually set in the page **KSET** of the sound level meter function.

K2**Correction Value k2**

The correction value k2 is based on either LCeq or LCpeak measurement. It is measured or manually set in the page **KSET** of the sound level meter function.

live**Parameter live**

Actual current sound pressure level.

max**Parameter max**

Maximum sound level of the measurement cycle.

min**Parameter min**

Minimum sound level of the measurement cycle.

off**Correction Value off**

No correction value, default setting.

PK**Peak Level**

Application example:

Measure L_{Cpeak} in accordance with DIN15905

The RTA spectrum analyzer measures the true peak level with the optional Extended Acoustic Pack. The peak hold time can be set to 0, 1 or 5 seconds.

%**Percentile Sound Level - Level Statistics**

The statistical distribution of sound pressure levels is commonly used for environmental noise analysis, such as road traffic or community noise assessments. For example, $L_{AFxx\%}$ is the noise level exceeded during xx% of the measurement period; e.g., $L_{AF90\%}$ is the noise level exceeded during 90% of the measurement period.

Please see the specifications at chapter Technical Data XL2-TA: Functions of Extended Acoustic Pack (optional) in this manual.

Prev**Previous Level**

Applicable for timer mode Repeat or Repeat Synchronized; displays the selected sound pressure level of the last measurement cycle.



Slow Time Weighting

Time constant $t = 1$ second; the time-weighting is an exponential function of time, which defines how changes of the instantaneous sound pressure level are averaged for useful sound level results. The decay rate is 4.3 dB/s.



Parameter T3

Clock-Impulse Maximum Level (Taktmaximalpegel) L_{AFT3} in accordance with DIN 45645-1; maximum sound pressure level measured with frequency weighting A and time weighting F within a time interval of 3 seconds.



Parameter T3eq

Time-average Clock-Impulse Maximum Level (Taktmaximalpegel) L_{AFT3eq} in accordance with DIN 45645-1 and DIN 45657.



Parameter T5

Clock-Impulse Maximum Level (Taktmaximalpegel) L_{AFT5} in accordance with DIN 45645-1; maximum sound pressure level measured with frequency weighting A and time weighting F within a time interval of 5 seconds.



Parameter T5eq

Time-average Clock-Impulse Maximum Level (Taktmaximalpegel) L_{AFT5eq} in accordance with DIN 45645-1 and DIN 45657.



Inverted X-Curve

In the film and recording industry an X curve is also known as a wide-range curve, e.g., used for cinema installations conforming to SMPTE ST 202:2010 or ISO 2969:2015 @ 500 seats.



Z-frequency weighting in accordance with IEC 61672 (= flat frequency response, no filter)

Overall sound pressure level, all sound signal components are included; required for special applications.





Sound Pressure Level Lp

Lp is a commonly used abbreviation for sound pressure level (p for pressure); for example, Lw is used for Sound Power Level





Appendix 4: Common Sound Levels

Display	Application	Setting
L_{AE}	<p>Sound Exposure Level</p> <p>The sound exposure level L_{AE} characterizes the total energy content of a signal and corresponds to the L_{Aeq} normalized to one second. The sound exposure level is measured for example to compare noise events with different time durations. The L_{AE} reports the amount of noise from an event such as an individual aircraft fly-over. An earlier used level name is SEL.</p> <p>$L_{AE} = L_{Aeq} + 10 \times \log(\text{time in seconds})$</p>	A -> E
L_{Aeq}	<p>Time-Average Sound Pressure Level or Equivalent Continuous Sound Pressure Level</p> <p>Averaged sound level over time with A frequency weighting.</p>	A -> EQ -> off
L_{Aeq-dt}	<p>Level L_{Aeq-dt} "delta t" in report</p> <p>Level of the preset logging interval in the LOG-menu; e.g. Logging interval = 1 second, then L_{Aeq-dt} is the time averaged level of the past 1 second.</p>	

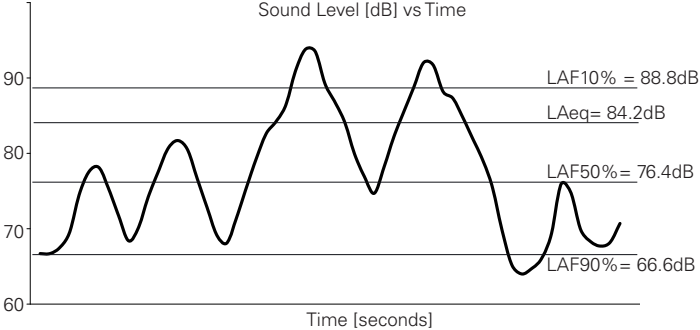
<p>L_{Aeq}+k1</p>	<p>Time-Average Sound Pressure Level with Correction Value The actual measurement position often differs to the loudest position of the live event. Thus, the correction value k1 is the correction value of L_{Aeq} between the loudest position and the actual measurement position, measured using pink noise. The correction value k1 is measured or manually set in the page KSET of the sound level meter function.</p>	<p>A -> EQ -> K1</p>
<p>L_{Aeqxx}</p>	<p>Moving Time-Average Sound Pressure Level Measurement of the moving sound level over time Leq with A-weighting frequency and F-weighting time responses; the parameter xx is user-defined from one second up to one hour. This level is also called "running Leq,T"; "gliding Leq,T" or "sliding Leq,T"</p> <p>Four individual levels can be configured, e.g.</p> <ul style="list-style-type: none"> • 5 seconds for live sound monitoring • 10 minutes (in accordance with the French standard) • 15 minutes (in accordance with the British standard) • 60 minutes (in accordance with V-NISSG) 	<p>A -> EQ_T -> 60' -> off</p>
<p>L_{Aeq20-200}</p>	<p>Time-Average Sound Pressure Level 20 - 200 Hz Summed time-averaged sound pressure level over time with A frequency weighting of the third-octave frequency bands 20 - 200 Hz.</p>	<p>MORE -> MORE</p>

L_{Aeq60'+k1}	<p>Moving Time-Average Sound Pressure Level with Correction Value k1</p> <p>The actual measurement position often differs to the loudest position of the live event. Thus, the correction value k1 is the correction value of L_{Aeq60'M} between the loudest position and the actual measurement position, measured using pink noise. The correction value k1 is measured or manually set in the page KSET of the sound level meter function.</p> <p>Application: Measurements in accordance with V-NISSG</p>	
L_{AF}	<p>Actual Sound Pressure Level</p> <p>Sound pressure level with A frequency weighting and F time weighting, compensating for human hearing perception at lower sound pressure levels; applicable at levels lower than 100 dB.</p>	
L_{AFmax}	<p>Maximum Sound Pressure Level</p> <p>Measures the maximum environmental noise level during the measurement period.</p>	
L_{AFmax_dt}	<p>Maximum Sound Pressure Level "delta t" in report</p> <p>Maximum level of the preset logging interval in the LOG-menu, e.g. 1 second.</p>	
L_{AFmin}	<p>Minimum Sound Pressure Level</p> <p>Measures the minimum environmental noise level during the measurement period.</p>	

<p>LAFmin-dt</p>	<p>Minimum Sound Pressure Level “delta t” in report Minimum level of the preset logging interval in the LOG-menu, e.g. 1 second.</p>	
<p>LAFxx%</p>	<p>Percentile Sound Pressure Level The statistical distribution of sound pressure levels is commonly used for environmental noise analysis, such as road traffic or community noise assessments. For example $L_{AFxx\%}$ is the noise level exceeded during xx% of the measurement period; e.g., $L_{AF90\%}$ is the noise level exceeded during 90% of the measurement period.</p> <p>Please see the specifications at chapter Technical Data XL2-TA: Functions of Extended Acoustic Pack (optional) in this manual.</p> 	<p>MORE -> % -> 90.0</p>

L_{Ceq}	<p>Time-Average Sound Pressure Level or Equivalent Continuous Sound Pressure Level Averaged sound level over time with C frequency weighting.</p>	
L_{CPK}	<p>Peak Sound Level Peak sound level with C frequency weighting. Measures the peak level. High peak levels can damage the human hearing.</p>	
L_{CPKmax}	<p>Maximum Peak Sound Level Maximum peak sound level with C frequency weighting. Measures the peak level. High peak levels can damage the human hearing.</p>	
L_{CPK-dt}	<p>Maximum Peak Sound Level „delta t“ in report Maximum peak sound level with C frequency weighting of the preset logging interval in the LOG-menu, e.g. 1 second.</p>	
L_{CPK+k2}	<p>Peak Sound Level with Correction Value The actual measurement position often differs to the loudest position of the live event. Thus, the correction value k2 is the correction value of L_{CPK} between the loudest position and the actual measurement position, measured using pink noise. The correction value k2 is measured or manually set in the page KSET of the sound level meter function.</p>	

L_{EX}

Noise Exposure Level L_{EX}

The Noise at Work Directive 2003/10/EC lays down minimum requirements for the protection of workers from risks to their health and safety arising or likely to arise from exposure to noise and in particular the risk to hearing.

- Steady noise $L_{EX,8h} = L_{Aeq}$: (applies to L_{AS} , deviation < 5 dB)
 L_{Aeq} measured over a short time equals $L_{EX,8h}$; the following formula applies for a measurement period < 8 hours:
 $L_{EX,8h} = L_{Aeq} + 10 \times \log (T / 8 \text{ hours})$
- Steady noise with stepped level variations:
 Measure L_{Aeq} at the different levels and enter the data with the corresponding exposure time in the NTi Audio noise exposure level post-processing form; the $L_{EX,8h}$ will be calculated and displayed.
- Varying noise levels:
 $L_{EX,8h} = L_{Aeq}$ measured for 8 hours

The exposure limit values and respective actions are:

	L _{EX} , 8h	L _{Cpeak}	Action
Lower limit value	80 dB(A)	135 dB	The employer shall make individual hearing protectors available to workers
Upper limit value	85 dB(A)	137 dB	Hearing protectors shall be used
Exposure limit	87 dB(A)	140 dB	The attenuation characteristics of the hearing protectors worn must adequately reduce the levels below this limit



Appendix 5: Vibration Meter Functions



Acceleration a

in units m/s², g, in/s², dB
 L_a [dB] = 20*log (a / 10⁻⁶)



Velocity v

in units m/s, in/s and dB;
 Velocity is calculated based on the acceleration a and the frequency f: $v = a / (2 * \pi * f)$
 L_v [dB] = 20*log (v / 10⁻⁹)



Displacement

in units m, in, dB;
 Displacement is calculated based on the acceleration a and the frequency f: $d = a / (2 * \pi * f)^2$
 L_d [dB] = 20*log (d / 10⁻¹²)



RMS level

Measurement result is based on RMS



Peak level

Measurement result is based on peak level

- Peak level $a(Pk) = \sqrt{2} * a$
- Peak level $v(Pk) = \sqrt{2} * v$
- Peak level $d(Pk) = \sqrt{2} * d$



Peak-peak Level

Measurement result is based on peak-peak level

- Peak-peak level $a(PP) = a(Pk) * 2$
- Peak-peak level $v(PP) = v(Pk) * 2$
- Peak-peak level $d(PP) = d(Pk) * 2$



Moving Time-Average Level or Moving Equivalent Continuous Level

with selectable time window 1, 2, 4 or 8 seconds.



Clock-Impulse Maximum Level (Taktmaximalpegel)

Maximum velocity during a periodic 30 seconds interval with time weighting F in accordance with DIN 4150-2.



Peak Particle Velocity PPV

Ground or blast vibration amplitude is often measured as particle velocity or the speed at which a particle vibrates. This is quantified as peak particle velocity **PPV** in the units [mm/s] or [in/s]. **PPV** equals the level type **vel Pk** on the XL2-TA.

Details IEC 61672 & IEC 61260

The XL2-TA Analyzer, with the M2230 or M2340 measurement microphone, fully complies with the standards IEC 61672:2013, IEC 61672:2003, IEC 61260:2014 and IEC 61260:2003 as an integrating class 1 Sound Level Meter with A, C, Z frequency weighting and fast/slow time weighting. The impulse time weighting is optionally available with the Extended Acoustic Package.

The type approval applies to the sound level meter in accordance with IEC 61672 and the Octave/Third-Octave measurement in accordance with IEC 61260. Attention should be given to the following recommendations on the environment and the configuration.

Environment

Persons and objects that are located in the sound field during the measurement have an absorbing, reflecting or shielding impact on the sound field and may therefore compromise the measurement result. Consequently, such objects should be removed from the sound field where appropriate. The measurement microphone should be mounted on a tripod. The operator should remain as far away as possible behind the microphone during the measurement.

Configuration “Microphone Detached”

- XL2-TA Sound Level Meter
 - Hardware version: D2, E0, E1
 - Firmware version 4.71
- M2230 Measurement Microphone, consisting of
 - Microphone Preamplifier MA220
 - Microphone Capsule MC230 or MC230A
- M2340 Measurement Microphone, consisting of
 - Microphone Preamplifier MA230
 - Microphone Capsule MC230A
- ASD Cable, 5 meter or 10 meter or 20 meter
- Class 1 Sound Calibrator CAL200
- Optional
 - Optional: Extended Acoustic Pack
 - NTi Audio Mains Power Adapter Exel Line
 - NTi Audio Microphone Clamp MH01
 - NTi Audio Windscreen, 50 mm
 - NTi Audio Windscreen, 90 mm
 - XL2 Input Keypad

With the microphone connected by the ASD Cable, the analyzer can be held in your hand during the measurement. This offers the convenience of watching the measurement values as they occur.

Configuration “Microphone Attached”

- XL2-TA Sound Level Meter
 - Hardware version: D2, E0, E1
 - Firmware version 4.71
 - Shroud MXA01
- M2230 Measurement Microphone, consisting of
 - Microphone Preamplifier MA220
 - Microphone Capsule MC230 or MC230A
- M2340 Measurement Microphone, consisting of
 - Microphone Preamplifier MA230
 - Microphone Capsule MC230A
- Class 1 Sound Calibrator CAL200
- Optional
 - Optional: Extended Acoustic Pack
 - NTi Audio Mains Power Adapter Exel Line
 - NTi Audio Windscreen, 50 mm
 - NTi Audio Windscreen, 90 mm
 - XL2 Input Keypad



There are no correction values required for these configurations.

Configuration “Outdoor Microphone Detached”

- XL2-TA Sound Level Meter
 - Hardware version: D2, E0, E1
 - Firmware version 4.71
- M2230 Measurement Microphone, consisting of
 - Microphone Preamplifier MA220
 - Microphone Capsule MC230 or MC230A
- M2340 Measurement Microphone, consisting of
 - Microphone Preamplifier MA230
 - Microphone Capsule MC230A
- Weather Protection WP30 with bird spike BS01
- ASD Cable, 5 meter or 10 meter or 20 meter
- Class 1 Sound Calibrator CAL200
- Optional
 - Optional: Extended Acoustic Pack
 - NTi Audio Mains Power Adapter Exel Line
 - XL2 Input Keypad
 - Dehumidifier for Weather Protection WP30



- There are no correction values required for the configuration “Outdoor Microphone Detached” at vertical noise incidents.
- Activate the corresponding correction in the Calibration menu for “Outdoor Microphone Detached” at horizontal noise incidents.

General Information

Reference Sound Pressure Level

The reference sound pressure level is 114 dBSPL relative to 20 μ Pa.

Reference Level Range

The reference level range is MID, 20 - 120 dBSPL

Reference Orientation

The microphone reference point is located in the middle of the microphone membrane. The 0° reference orientation and the orientation of the membrane's surface normal is identical.

Verified Frequency Range

20 Hz to 20 kHz

Greatest Peak-To-Peak Voltage at the Electric Input

(Refer IEC61672-1 paragraphs 5.1.16, 9.3.i)

The highest sound pressure level at the M2230 microphone with a sensitivity of $S = 42$ mV/Pa is 143.5 dB.

Initial Time Interval after Power On (IEC61672-1, 5.1.18)

The XL2-TA Sound Level Meter and M2230 microphone meet the given specifications for the electro-acoustical response after an initial time interval of no more than one minute following

switching on the power. This assumes that the devices have been allowed to reach equilibrium with the prevailing ambient environment before switching on the power.

Insertion of Electrical Signals

(Refer IEC61672-1 paragraphs 5.1.15, 9.3g)

The capsule replacement NTI-K65-15 can be used to insert electrical signals to the preamplifier MA220. The device provides at one side a contact that corresponds to the center contact of the replaced microphone capsule, at the other side a BNC-plug for the electrical signals. The impedance at the output of the device is 15 pF with a maximum deviation of ± 1 pF. The electrical noise floor is measured by shorting the contacts of the BNC plug. Before the NTI-K65-15 can be mounted to the preamplifier MA220, the microphone capsule must first be detached. The nominal sensitivity S of the capsule is $S = 42$ mV/Pa. Measurements with the NTI-K65-15 therefore require that the sensitivity in the calibration menu is manually adjusted to $S = 42$ mV/Pa.

The maximum electrical input voltage is 36 Vpp. The attenuation between the device and the XLR input of the XL2-TA is 0.78 dB at a reference frequency of 1 kHz. A 1 kHz signal with 459 mVrms level is required at the input of the device, to substitute the signal of a microphone capsule with the sensitivity 42 mV/Pa at a reference level of 114 dBSPL.

Output (Refer IEC61672-1 paragraphs 5.16.1, 9.2.5p)

The instrument provides no electrical analog or digital outputs for measurements.

Typical Time Interval Needed to Stabilize after Changes in Environmental Conditions (IEC61672-1, 6.1.2, 9.3l)

Recommended time interval for stabilizing the sound level meter after changes in environmental conditions, prior to performing any measurements:

Change in the environmental condition		Time Interval
Temperature	± 5 °C	15 minutes
Temperature	± 20 °C	30 minutes
Air pressure	± 5 kPa	15 seconds
Humidity	$\pm 30\%$	15 minutes

The time intervals apply, for instance, after moving from a cold into a warm room, and assume that combinations of air temperature and relative humidity do not yield a dew point greater than +39 °C or less than -15 °C.

No Limit on Operational Environment

(Refer IEC61672-1 paragraphs 6.3.2, 9.2.7a)

There are no restrictions in place for parts or components, which would limit the operational environment.

Exposure to Electrostatic Discharges

(Refer IEC61672-1 paragraphs 6.5.2, 9.2.7b)

Heavy electrostatic discharges directly to the instrument's connector or keyboard may interrupt the operation. The XL2-TA either switches off or freezes at the last valid measurement value. In such a case re-start the instrument. If the data logging had been active prior the interrupt, the log file may contain a gap. However, the acquired results can be identified correctly as each one is saved together with its own individual time stamp.

Exposure to AC Power and Radio Frequency Fields

(Refer IEC61672-1 paragraphs 6.6.1, 9.2.7c)

The sound level meter complies with the requirements of the standards IEC61672-1:2013 and IEC61260-1:2014 regarding immunity against high frequency fields or mains power fields from 50 to 60 Hz.

Impact of Electromagnetic Fields

If the device is exposed to electromagnetic fields of 10 V/m, the measurement of sound levels below 74 dB is not specified. If the electromagnetic fields exceed 10 V/m, the exposed instrument is not specified in any level range.

Susceptibility to AC Power and Radio Frequency Fields

(Refer IEC61672-1 paragraphs 6.6.3, 9.3o)

The device has the greatest susceptibility to AC power frequency fields, if the direction of the magnetic field is the same as the orientation of the microphone axis.

The device has the greatest susceptibility to radio frequency fields in the lowest measurement range, if the surface normal of the display and the direction of the incoming radio frequency field are parallel to each other and the power supply is connected. In this case, the sound level meter should be operated without a power supply. The configuration with the greatest radio-frequency emissions levels is provided by connecting the mains power adapter to the sound level meter.

Measuring Low-Level Sound Fields

(Refer IEC61672-1 paragraphs 5.6.5, 9.2.5d)

If the sound level is very low, the measurement result is affected by the noise floor of the sound level meter. The specified configuration complies with class 1 within the given linear measuring range.

Influence of the ASD Cable

(Refer IEC61672-1 paragraphs 7.1, 9.2.6b)

The ASD Cable serves as connection cable between the XL2-TA sound level meter and the microphone in the detached configuration. There are no correction values required for this configuration.

Influence of Mechanical Vibrations

Mechanical vibrations with 1 m/s² acceleration perpendicular to the membrane of the microphone, will raise the lower limit of the linear operating range to 71 dB (A-weighted) for the frequencies 31,5 Hz, 63 Hz, 126 Hz, 250 Hz, 500 Hz, 630 Hz, 800 Hz and 1000 Hz. Mechanical vibrations with 1 m/s² acceleration parallel to the membrane of the microphone, will raise the lower limit of the linear operating range to 68 dB (A-weighted) for the frequencies 31,5 Hz, 63 Hz, 126 Hz, 250 Hz, 500 Hz, 630 Hz, 800 Hz and 1000 Hz.

Modes of Operation and Accessories

The greatest susceptibility to radio frequency fields is independent of operation mode or connected accessories.

Volume of Measurement Microphone M2230

- Equivalent Diaphragm Volume = 50 mm³
- Volume between grid and membran/housing = 92.5 mm³
- Calibrator Load Volume = 142.5 mm³

Class 1 Sound Calibrator

(Refer IEC61672-1 paragraphs 5.2.1, 5.2.7, 9.3d)

If an obligatory calibration is required for the sound level meter, in accordance with the type approval, then the Class 1 Sound Calibrator CAL200 should be used.

Technical Details

- Type: Larson Davis CAL200
- Level correction: -0.1 dB
- Calibration frequency: 1 kHz (= reference frequency)
- Calibration level: 114 dB (= reference sound pressure level)

Details for Calibration

The calibration has to be executed according to the instructions given in chapter "Calibration". Ensure that the calibrator is set to 114 dB.

Add the free-field correction values to the reference sound pressure level, and enter the result into the XL2-TA under "Calibration Level".

Accessory

Input Keypad

The Input Keypad has no effect on measured sound pressure levels of the instrument.

Level Linearity

(Refer IEC61672-1 paragraphs 5.5.3, 5.5.9, 9.2.2e, 9.3e, 9.3f).
 All values refer to $S_{ref} = 42 \text{ mV/Pa}^*$. The starting levels for the level linearity tests are listed in the following tables:

Level range: Low

[dB]	Frequency					
	$L_{A\tau}^*$	$L_{C\tau}^*$	$L_{Z\tau}^*$	L_{AeqT}^*	L_{AE}^* ($t_{int} = 10s$)	L_{Cpeak}^*
31,5 Hz	from 24 to 68 starting 54	from 27 to 105 starting 94	from 30 to 108 starting 94	from 24 to 68 starting 54	from 34 to 78 starting 54	
1 kHz	from 24 to 108 starting 94	from 27 to 108 starting 94	from 30 to 108 starting 94	from 24 to 108 starting 94	from 34 to 118 starting 104	from 41 to 111
4 kHz	from 24 to 109 starting 94	from 27 to 107 starting 94	from 30 to 108 starting 94	from 24 to 109 starting 94	from 34 to 119 starting 104	
8 kHz	from 24 to 107 starting 94	from 27 to 105 starting 94	from 30 to 108 starting 94	from 24 to 107 starting 94	from 34 to 117 starting 104	
12,5 kHz	from 24 to 104 starting 94	from 27 to 102 starting 94	from 30 to 108 starting 94	from 24 to 104 starting 94	from 34 to 114 starting 104	

Level range: Mid

[dB]	Frequency					
	$L_{A\tau}^*$	$L_{C\tau}^*$	$L_{Z\tau}^*$	L_{AeqT}^*	L_{AE}^* ($t_{int} = 10s$)	L_{Cpeak}^*
31,5 Hz	from 31 to 86 starting 54	from 32 to 123 starting 114	from 35 to 126 starting 114	from 31 to 86 starting 54	from 41 to 96 starting 54	
1 kHz	from 31 to 126 starting 114	from 32 to 126 starting 114	from 35 to 126 starting 114	from 31 to 126 starting 114	from 41 to 136 starting 124	from 38 to 129
4 kHz	from 31 to 127 starting 114	from 32 to 126 starting 114	from 35 to 126 starting 114	from 31 to 127 starting 114	from 41 to 137 starting 124	
8 kHz	from 31 to 126 starting 114	from 32 to 123 starting 114	from 35 to 126 starting 114	from 31 to 126 starting 114	from 41 to 135 starting 124	
12,5 kHz	from 31 to 122 starting 114	from 32 to 120 starting 114	from 35 to 126 starting 114	from 31 to 126 starting 114	from 41 to 132 starting 124	

* If the sensitivity S_x deviates from the given data, a correction value of $20 \cdot \log(S_{ref}/S_x)$ has to be added.
 Example: $S_x = 45 \text{ mV/Pa}$ -> correction value = $20 \cdot \log(42/45) = -0.6 \text{ dB}$

Level range: High

[dB]	Frequency										
	$L_{A\tau}^*$		$L_{C\tau}^*$		$L_{Z\tau}^*$		L_{AeqT}^*		L_{AE}^* ($t_{int} = 10s$)		L_{Cpeak}^*
31,5 Hz	from 53 to 98 starting 94	from 51 to 137 starting 114	from 56 to 137 starting 114	from 53 to 98 starting 94	from 63 to 108 starting 94						
1 kHz	from 53 to 137 starting 114	from 51 to 137 starting 114	from 56 to 137 starting 114	from 53 to 137 starting 114	from 63 to 147 starting 124	from 65 to 140					
4 kHz	from 53 to 138 starting 114	from 51 to 137 starting 114	from 56 to 137 starting 114	from 53 to 138 starting 114	from 63 to 148 starting 124						
8 kHz	from 53 to 136 starting 114	from 51 to 137 starting 114	from 56 to 137 starting 114	from 53 to 136 starting 114	from 63 to 146 starting 124						
12,5 kHz	from 53 to 133 starting 114	from 51 to 131 starting 114	from 56 to 137 starting 114	from 53 to 133 starting 114	from 63 to 143 starting 124						

Sound pressure levels, which continuously exceed the specified linear measurement range and overload the microphone preamplifier, may cause in extreme cases a displayed level below the actual sound pressure level.

Level Linearity of Octaveband-Spectrum

in accordance with IEC 61260.

All values refer to $S_{ref} = 42 \text{ mV/Pa}^*$.

Nominal Frequency Hz	Level Range		
	LOW	MID	HIGH
20	45-108 dB	20-126 dB	32-137 dB
31.5	25-108 dB	20-126 dB	32-137 dB
63	23-108 dB	20-126 dB	32-137 dB
125	14-108 dB	17-126 dB	33-137 dB
250	13-108 dB	15-126 dB	34-137 dB
500	13-108 dB	15-126 dB	36-137 dB
1000	15-108 dB	16-126 dB	39-137 dB
2000	17-108 dB	18-126 dB	41-137 dB
4000	19-108 dB	20-126 dB	44-137 dB
8000	19-108 dB	23-126 dB	47-137 dB
16000	18-108 dB	28-126 dB	51-137 dB

The sampling rate of the filters is 48 kHz.

* If the sensitivity S_x deviates from the given data, a correction value of $20 \cdot \log(S_{ref}/S_x)$ has to be added.

Example: $S_x = 45 \text{ mV/Pa}$ -> correction value = $20 \cdot \log(42/45) = -0.6 \text{ dB}$

Level Linearity of Third-Octaveband-Spectrum

in accordance with IEC 61260.

All values refer to $S_{ref} = 42 \text{ mV/Pa}^*$.

Nominal Frequency Hz	Level Range		
	LOW	MID	HIGH
12.5	48-108 dB	17-126 dB	29-137 dB
16	46-108 dB	17-126 dB	29-137 dB
20	43-108 dB	17-126 dB	29-137 dB
25	41-108 dB	16-126 dB	29-137 dB
31.5	37-108 dB	15-126 dB	29-137 dB
40	28-108 dB	14-126 dB	29-137 dB
50	23-108 dB	13-126 dB	29-137 dB
63	19-108 dB	12-126 dB	29-137 dB
80	11-108 dB	11-126 dB	29-137 dB
100	9-108 dB	11-126 dB	29-137 dB
125	8-108 dB	10-126 dB	29-137 dB
160	8-108 dB	10-126 dB	29-137 dB
200	8-108 dB	10-126 dB	29-137 dB
250	7-108 dB	10-126 dB	29-137 dB
315	8-108 dB	10-126 dB	30-137 dB
400	8-108 dB	11-126 dB	30-137 dB
500	8-108 dB	11-126 dB	31-137 dB
630	9-108 dB	11-126 dB	31-137 dB
800	9-108 dB	11-126 dB	32-137 dB
1000	10-108 dB	11-126 dB	34-137 dB
1250	11-108 dB	12-126 dB	35-137 dB

Nominal Frequency Hz	Level Range		
	LOW	MID	HIGH
1600	11-108 dB	12-126 dB	35-137 dB
2000	13-108 dB	13-126 dB	36-137 dB
2500	13-108 dB	14-126 dB	37-137 dB
3150	14-108 dB	14-126 dB	38-137 dB
4000	14-108 dB	15-126 dB	39-137 dB
5000	15-108 dB	16-126 dB	40-137 dB
6300	15-108 dB	17-126 dB	41-137 dB
8000	15-108 dB	18-126 dB	42-137 dB
10000	15-108 dB	19-126 dB	43-137 dB
12500	14-108 dB	21-126 dB	44-137 dB
16000	13-108 dB	23-126 dB	48-137 dB
20000	13-108 dB	26-126 dB	50-137 dB

The sampling rate of the filters is 48 kHz.

* If the sensitivity S_x deviates from the given data, a correction value of $20 \cdot \log(S_{ref}/S_x)$ has to be added.

Example: $S_x = 45 \text{ mV/Pa}$ -> correction value = $20 \cdot \log(42/45) = -0.6 \text{ dB}$

Self-generated Noise with Microphone

(Refer IEC61672-1 paragraphs 5.6.1 to 5.6.4, 9.2.5o)

Self-generated noise with electrical input device @ $S = 42 \text{ mV/Pa}$

Frequency-weighting	Level range [dB]		
	low	mid	high
Z	22	23	46
A	11	19	43
C	14	18	42

Self-generated noise with M2230 microphone @ $S = 42 \text{ mV/Pa}$

Frequency-weighting	Level range [dB]		
	low	mid	high
Z	23	25	46
A	17	21	43
C	20	22	42

The averaging time is 30 seconds for all measurements.

Frequency Response Corrections

(Refer IEC61672-1 paragraphs 5.2.4, 5.2.5, 5.2.6 und 9.2.4d)

The below listed wind screen corrections may be selected in the XL2-TA Sound Level Meter.

The listed uncertainty applies for all here listed measurements and corrections. Its calculated for a level of confidence of 95% with a coverage factor $k=2$. It represents the maximum permitted expanded uncertainty in accordance with IEC 62585.

Nominal Frequency	Actual Frequency	0° Free-field Frequency Response	0° Free-field Correction	Housing Reflection and Microphone Diffraction Correction	Impact of 50 mm Wind Screen	0° Free-field Correction with 50 mm Wind Screen	Impact of 90 mm Wind Screen	0° Free-field Correction with 90 mm Wind Screen	Measurement Uncertainty
Hz	Hz	dB	dB	dB	dB	dB	dB	dB	dB
63	63.10	0.0	0.0	0.0	0.0	0.0	0.0	0.0	0.20
125	125.89	0.0	0.0	0.0	0.0	0.0	0.0	0.0	0.20
250	251.19	0.0	0.0	0.0	0.0	0.0	0.0	0.0	0.20
315	316.23	0.0	0.0	0.0	0.0	0.0	0.0	0.0	0.20
400	398.11	0.0	0.0	0.0	0.0	0.0	0.1	-0.1	0.20
500	501.19	0.0	0.0	0.0	0.0	0.0	0.1	-0.1	0.20
630	630.96	0.0	0.0	0.0	0.0	0.0	0.1	-0.1	0.20
800	794.33	0.0	0.0	0.0	0.0	0.0	0.2	-0.2	0.20
1000	1000.00	0.0	0.0	0.0	0.0	0.0	0.2	-0.2	0.20
1060	1059.25	0.0	0.0	0.0	0.0	0.0	0.2	-0.2	0.20
1120	1122.02	0.0	0.0	0.0	0.1	-0.1	0.2	-0.2	0.20
1180	1188.50	0.0	0.0	0.0	0.1	-0.1	0.2	-0.2	0.20
1250	1258.93	0.0	0.0	0.0	0.1	-0.1	0.2	-0.2	0.20

Nominal Frequency	Actual Frequency	0° Free-field Frequency Response	0° Free-field Correction	Housing Reflection and Microphone Diffraction Correction	Impact of 50 mm Wind Screen	0° Free-field Correction with 50 mm Wind Screen	Impact of 90 mm Wind Screen	0° Free-field Correction with 90 mm Wind Screen	Measurement Uncertainty
1320	1333.52	0.0	0.0	0.0	0.1	-0.1	0.2	-0.2	0.20
1400	1412.54	0.0	0.0	0.0	0.1	-0.1	0.2	-0.2	0.20
1500	1496.24	0.0	0.0	0.0	0.1	-0.1	0.3	-0.3	0.20
1600	1584.89	0.0	0.0	0.0	0.1	-0.1	0.3	-0.3	0.20
1700	1678.80	0.0	0.0	0.0	0.1	-0.1	0.3	-0.3	0.20
1800	1778.28	0.0	0.0	0.0	0.1	-0.1	0.3	-0.3	0.20
1900	1883.65	0.0	0.0	0.0	0.2	-0.2	0.3	-0.3	0.20
2000	1995.26	0.0	0.0	0.0	0.2	-0.2	0.3	-0.3	0.20
2120	2113.49	0.0	0.0	0.0	0.2	-0.2	0.3	-0.3	0.20
2240	2238.72	0.0	0.0	0.0	0.2	-0.2	0.3	-0.3	0.20
2360	2371.37	0.0	0.0	0.0	0.3	-0.3	0.3	-0.3	0.20
2500	2511.89	0.0	0.0	0.0	0.3	-0.3	0.2	-0.2	0.20
2650	2660.73	0.0	0.0	0.0	0.3	-0.3	0.1	-0.1	0.20
2800	2818.38	0.0	0.0	0.0	0.3	-0.3	0.1	-0.1	0.20
3000	2985.38	0.0	0.0	0.0	0.4	-0.4	0.0	0.0	0.20
3150	3162.28	0.0	0.0	0.0	0.4	-0.4	-0.1	0.1	0.20
3350	3349.65	0.0	0.0	0.0	0.4	-0.4	-0.2	0.2	0.20
3550	3548.13	0.0	0.0	0.0	0.5	-0.5	-0.2	0.2	0.20
3750	3758.37	0.0	0.0	0.0	0.5	-0.5	-0.2	0.2	0.20
4000	3981.07	0.0	0.0	0.0	0.5	-0.5	-0.2	0.2	0.20
4250	4216.97	0.0	0.0	0.0	0.6	-0.6	-0.1	0.1	0.30

Nominal Frequency	Actual Frequency	0° Free-field Frequency Response	0° Free-field Correction	Housing Reflection and Microphone Diffraction Correction	Impact of 50 mm Wind Screen	0° Free-field Correction with 50 mm Wind Screen	Impact of 90 mm Wind Screen	0° Free-field Correction with 90 mm Wind Screen	Measurement Uncertainty
4500	4466.84	0.0	0.0	0.0	0.6	-0.6	-0.1	0.1	0.30
4750	4731.51	0.0	0.0	0.0	0.6	-0.6	-0.1	0.1	0.30
5000	5011.87	0.0	0.0	0.0	0.6	-0.6	-0.1	0.1	0.30
5300	5308.84	0.0	0.0	0.0	0.5	-0.5	-0.2	0.2	0.30
5600	5623.41	0.0	0.0	0.0	0.5	-0.5	-0.3	0.3	0.30
6000	5956.62	0.0	0.0	0.0	0.4	-0.4	-0.4	0.4	0.30
6300	6309.57	0.0	0.0	0.0	0.3	-0.3	-0.4	0.4	0.30
6700	6683.44	0.0	0.0	0.0	0.3	-0.3	-0.4	0.4	0.30
7100	7079.46	0.0	0.0	0.0	0.2	-0.2	-0.3	0.3	0.30
7500	7498.94	0.0	0.0	0.0	0.1	-0.1	-0.3	0.3	0.30
8000	7943.28	0.0	0.0	0.0	0.1	-0.1	-0.3	0.3	0.30
8500	8413.95	0.0	0.0	0.0	0.1	-0.1	-0.4	0.4	0.45
9000	8912.51	0.0	0.0	0.0	0.1	-0.1	-0.5	0.5	0.45
9500	9440.61	0.0	0.0	0.0	0.1	-0.1	-0.6	0.6	0.45
10000	10000.00	0.0	0.0	0.0	0.1	-0.1	-0.5	0.5	0.45
10600	10592.54	0.0	0.0	0.0	0.1	-0.1	-0.6	0.6	0.45
11200	11220.18	0.0	0.0	0.0	0.1	-0.1	-0.7	0.7	0.45
11800	11885.02	0.0	0.0	0.0	0.0	0.0	-0.8	0.8	0.45
12500	12589.25	0.0	0.0	0.0	-0.2	0.2	-0.8	0.8	0.45
13200	13335.21	0.0	0.0	0.0	-0.3	0.3	-0.9	0.9	0.45
14000	14125.38	0.0	0.0	0.0	-0.5	0.5	-0.9	0.9	0.45

Nominal Frequency	Actual Frequency	0° Free-field Frequency Response	0° Free-field Correction	Housing Reflection and Microphone Diffraction Correction	Impact of 50 mm Wind Screen	0° Free-field Correction with 50 mm Wind Screen	Impact of 90 mm Wind Screen	0° Free-field Correction with 90 mm Wind Screen	Measurement Uncertainty
15000	14962.36	0.0	0.0	0.0	-0.6	0.6	-1.1	1.1	0.45
16000	15848.93	0.0	0.0	0.0	-0.6	0.6	-1.1	1.1	0.45
17000	16788.04	0.0	0.0	0.0	-0.6	0.6	-1.2	1.2	0.45
18000	17782.79	0.0	0.0	0.0	-0.6	0.6	-1.5	1.5	0.45
19000	18836.49	0.0	0.0	0.0	-0.7	0.7	-1.7	1.7	0.45
20000	19952.62	0.0	0.0	0.0	-0.9	0.9	-1.5	1.5	0.45

Frequency Weighting

Nominal Frequency Hz	Frequency Weighting dB		
	A	C	Z
10	-70.4	-14.3	0.0
12.5	-63.4	-11.2	0.0
16	-56.7	-8.5	0.0
20	-50.5	-6.2	0.0
25	-44.7	-4.4	0.0
31.5	-39.4	-3.0	0.0
40	-34.6	-2.0	0.0
50	-30.2	-1.3	0.0
63	-26.2	-0.8	0.0
80	-22.5	-0.5	0.0
100	-19.1	-0.3	0.0
125	-16.1	-0.2	0.0
160	-13.4	-0.1	0.0
200	-10.9	0.0	0.0
250	-8.6	0.0	0.0
315	-6.6	0.0	0.0
400	-4.8	0.0	0.0
500	-3.2	0.0	0.0
630	-1.9	0.0	0.0
800	-0.8	0.0	0.0
1000	0	0	0
1250	+0.6	0.0	0.0
1600	+1.0	-0.1	0.0
2000	+1.2	-0.2	0.0
2500	+1.3	-0.3	0.0

Nominal Frequency Hz	Frequency Weighting dB		
	A	C	Z
3150	+1.2	-0.5	0.0
4000	+1.0	-0.8	0.0
5000	+0.5	-1.3	0.0
6300	-0.1	-2.0	0.0
8000	-1.1	-3.0	0.0
10000	-2.5	-4.4	0.0
12500	-4.3	-6.2	0.0
16000	-6.6	-8.5	0.0
20000	-9.3	-11.2	0.0

Directional Response (dB)

Based on the sound-incidence angle. (Refer IEC61672-1 paragraphs 5.3.1, 5.3.2 and 9.2.2b).

The impact on the directional response of the Windscreen 50 mm, Windscreen 90 mm and the Weather Protection WP30 is calculated by adding the frequency response correction at 0° to the below table.

Nominal Frequency [Hz]	Actual Frequency [Hz]	Angle in Degrees																		
		0	5	10	15	20	25	30	35	40	45	50	55	60	65	70	75	80	85	
250	251.19	-0.00	0.00	0.00	-0.00	0.00	-0.00	0.00	0.00	0.00	0.00	0.00	0.00	0.00	0.00	0.00	0.00	0.00	0.00	
315	316.23	-0.00	0.01	0.01	-0.00	0.02	-0.01	0.01	0.01	0.01	0.01	0.01	-0.01	0.01	-0.01	0.00	0.01	-0.01	0.00	0.01
400	398.11	0.00	0.01	0.01	-0.00	0.02	-0.02	-0.01	0.00	0.00	0.00	0.00	-0.01	0.01	-0.02	-0.01	0.00	-0.02	0.00	0.00
500	501.19	-0.00	-0.02	-0.02	-0.01	-0.00	-0.02	-0.02	-0.01	-0.03	-0.04	-0.04	-0.04	-0.04	-0.05	-0.05	-0.02	-0.04	-0.04	-0.04
630	630.96	-0.00	-0.09	-0.11	-0.06	-0.04	0.00	0.01	-0.05	-0.05	-0.06	-0.11	-0.11	-0.13	-0.08	-0.07	-0.10	-0.11	-0.13	-0.13
800	794.33	-0.00	-0.00	-0.01	-0.02	0.00	0.00	0.02	0.00	0.00	0.00	-0.03	0.00	-0.01	0.01	0.02	-0.01	-0.03	-0.03	-0.04
1000	1000.00	-0.00	0.03	0.00	-0.02	0.03	-0.02	0.00	-0.01	0.00	-0.01	-0.01	0.03	0.00	-0.01	0.04	0.01	0.02	0.03	0.03
1060	1059.25	-0.00	0.03	0.01	-0.02	0.02	-0.03	-0.01	-0.03	-0.03	-0.03	-0.04	0.00	-0.02	-0.02	0.02	-0.01	0.00	0.02	0.02
1120	1122.02	-0.00	0.02	0.01	-0.02	0.00	-0.04	-0.02	-0.05	-0.06	-0.06	-0.06	-0.06	-0.05	-0.06	-0.05	-0.01	-0.03	-0.02	-0.01
1180	1188.50	0.00	0.01	0.01	-0.03	-0.02	-0.05	-0.04	-0.08	-0.09	-0.08	-0.10	-0.10	-0.12	-0.11	-0.07	-0.07	-0.06	-0.06	-0.06
1250	1258.93	0.00	-0.01	-0.02	-0.06	-0.05	-0.09	-0.07	-0.14	-0.14	-0.15	-0.16	-0.17	-0.21	-0.20	-0.16	-0.16	-0.13	-0.14	-0.14
1320	1333.52	-0.00	-0.02	-0.05	-0.09	-0.07	-0.12	-0.10	-0.18	-0.17	-0.21	-0.23	-0.24	-0.29	-0.27	-0.26	-0.26	-0.24	-0.22	-0.22
1400	1412.54	0.00	-0.01	-0.04	-0.07	-0.04	-0.09	-0.07	-0.13	-0.12	-0.18	-0.21	-0.24	-0.29	-0.27	-0.29	-0.28	-0.31	-0.26	-0.26
1500	1496.24	-0.00	0.02	0.00	-0.01	0.00	-0.03	-0.02	-0.06	-0.06	-0.11	-0.14	-0.18	-0.23	-0.26	-0.27	-0.27	-0.32	-0.27	-0.27
1600	1584.89	-0.00	0.03	0.02	0.00	0.02	-0.00	0.01	-0.01	-0.02	-0.06	-0.09	-0.12	-0.17	-0.23	-0.26	-0.28	-0.30	-0.29	-0.29
1700	1678.80	-0.00	0.02	0.01	0.00	0.04	0.01	0.05	0.04	0.05	0.03	0.00	-0.03	-0.07	-0.12	-0.17	-0.26	-0.25	-0.26	-0.26
1800	1778.28	-0.00	0.02	0.00	0.01	0.04	0.02	0.04	0.04	0.06	0.07	0.09	0.06	0.00	-0.05	-0.06	-0.18	-0.22	-0.22	-0.22
1900	1883.65	-0.00	0.00	-0.02	-0.01	0.01	0.01	0.04	0.03	0.05	0.05	0.09	0.13	0.08	0.02	0.00	-0.08	-0.17	-0.23	-0.23
2000	1995.26	-0.00	0.01	-0.02	-0.03	-0.03	-0.05	-0.05	-0.08	-0.04	0.00	-0.02	0.06	0.04	0.07	0.01	-0.08	-0.12	-0.25	-0.25
2120	2113.49	-0.00	0.02	-0.01	-0.05	-0.05	-0.10	-0.13	-0.18	-0.22	-0.18	-0.19	-0.10	-0.14	-0.06	-0.01	-0.17	-0.19	-0.27	-0.27
2240	2238.72	0.00	0.02	-0.01	-0.06	-0.08	-0.16	-0.21	-0.25	-0.31	-0.36	-0.44	-0.37	-0.34	-0.32	-0.26	-0.26	-0.33	-0.39	-0.39
2360	2371.37	-0.00	0.02	0.00	-0.03	-0.03	-0.10	-0.13	-0.22	-0.30	-0.39	-0.46	-0.51	-0.56	-0.47	-0.42	-0.40	-0.33	-0.47	-0.47
2500	2511.89	-0.00	0.01	-0.00	-0.03	-0.03	-0.08	-0.08	-0.11	-0.16	-0.29	-0.44	-0.48	-0.58	-0.64	-0.52	-0.50	-0.45	-0.41	-0.41
2650	2660.73	0.00	0.00	-0.01	-0.05	-0.02	-0.03	-0.01	-0.01	-0.06	-0.09	-0.21	-0.34	-0.49	-0.55	-0.62	-0.54	-0.48	-0.42	-0.42
2800	2818.38	0.00	0.01	-0.01	-0.03	-0.03	-0.09	-0.10	-0.08	-0.07	-0.09	-0.16	-0.18	-0.36	-0.51	-0.58	-0.70	-0.57	-0.55	-0.55

Nominal Frequency [Hz]	Actual Frequency [Hz]	Angle in Degrees																	
		0	5	10	15	20	25	30	35	40	45	50	55	60	65	70	75	80	85
3000	2985.38	-0.00	0.00	-0.03	-0.09	-0.12	-0.19	-0.20	-0.25	-0.31	-0.31	-0.30	-0.34	-0.43	-0.52	-0.70	-0.79	-0.84	-0.73
3150	3162.28	-0.00	0.01	-0.00	-0.06	-0.06	-0.13	-0.18	-0.30	-0.36	-0.42	-0.49	-0.47	-0.51	-0.62	-0.70	-0.92	-0.95	-0.97
3350	3349.65	-0.00	0.01	0.01	0.00	-0.01	-0.06	-0.09	-0.15	-0.23	-0.37	-0.46	-0.46	-0.55	-0.55	-0.67	-0.82	-1.05	-1.01
3550	3548.13	-0.00	0.02	0.02	0.01	0.00	-0.03	0.01	0.00	-0.07	-0.18	-0.29	-0.40	-0.47	-0.50	-0.48	-0.65	-0.84	-1.08
3750	3758.37	-0.00	0.01	-0.01	-0.07	-0.08	-0.12	-0.09	-0.09	-0.10	-0.11	-0.22	-0.35	-0.49	-0.62	-0.54	-0.60	-0.78	-0.98
4000	3981.07	-0.00	0.01	-0.02	-0.10	-0.16	-0.24	-0.30	-0.36	-0.39	-0.35	-0.38	-0.41	-0.62	-0.76	-0.86	-0.83	-0.87	-1.11
4250	4216.97	-0.00	-0.00	-0.02	-0.07	-0.09	-0.18	-0.25	-0.40	-0.50	-0.54	-0.60	-0.52	-0.64	-0.77	-0.93	-1.10	-1.01	-1.01
4500	4466.84	-0.00	0.02	-0.01	-0.03	-0.02	-0.06	-0.07	-0.18	-0.27	-0.42	-0.57	-0.58	-0.56	-0.66	-0.77	-1.00	-1.12	-1.05
4750	4731.51	-0.00	0.01	-0.02	-0.08	-0.10	-0.17	-0.14	-0.18	-0.19	-0.32	-0.47	-0.66	-0.70	-0.71	-0.73	-0.94	-1.16	-1.18
5000	5011.87	-0.00	0.00	-0.05	-0.14	-0.20	-0.35	-0.44	-0.54	-0.53	-0.60	-0.63	-0.82	-1.01	-1.12	-1.09	-1.15	-1.41	-1.62
5300	5308.84	0.00	0.02	-0.01	-0.07	-0.10	-0.26	-0.39	-0.58	-0.71	-0.85	-0.87	-0.90	-1.07	-1.30	-1.40	-1.36	-1.43	-1.76
5600	5623.41	-0.00	0.02	-0.01	-0.04	-0.04	-0.10	-0.15	-0.29	-0.45	-0.71	-0.88	-0.94	-1.01	-1.16	-1.39	-1.51	-1.44	-1.54
6000	5956.62	-0.00	0.00	-0.03	-0.12	-0.17	-0.24	-0.27	-0.32	-0.38	-0.57	-0.80	-1.03	-1.20	-1.26	-1.41	-1.71	-1.77	-1.69
6300	6309.57	0.00	0.00	-0.05	-0.13	-0.20	-0.36	-0.45	-0.52	-0.59	-0.67	-0.82	-1.11	-1.40	-1.52	-1.56	-1.83	-2.15	-2.05
6700	6683.44	-0.00	0.01	-0.03	-0.09	-0.14	-0.30	-0.46	-0.67	-0.84	-0.88	-0.94	-1.05	-1.41	-1.78	-1.85	-1.87	-2.17	-2.47
7100	7079.46	-0.00	0.00	-0.05	-0.12	-0.15	-0.22	-0.25	-0.37	-0.56	-0.90	-1.12	-1.09	-1.17	-1.52	-1.96	-2.03	-2.00	-2.38
7500	7498.94	-0.00	0.00	-0.09	-0.21	-0.33	-0.58	-0.71	-0.82	-0.84	-0.96	-1.31	-1.66	-1.82	-1.81	-2.11	-2.57	-2.58	-2.68
8000	7943.28	-0.00	0.00	-0.03	-0.09	-0.15	-0.30	-0.50	-0.77	-1.08	-1.26	-1.30	-1.46	-1.91	-2.16	-2.21	-2.55	-2.90	-3.00
8500	8413.95	0.00	-0.01	-0.08	-0.18	-0.25	-0.37	-0.44	-0.54	-0.71	-1.11	-1.52	-1.63	-1.75	-2.09	-2.41	-2.56	-2.89	-3.30
9000	8912.51	0.00	-0.00	-0.08	-0.20	-0.32	-0.61	-0.82	-1.10	-1.22	-1.31	-1.56	-2.04	-2.42	-2.47	-2.78	-3.18	-3.29	-3.76
9500	9440.61	-0.00	-0.01	-0.12	-0.23	-0.26	-0.41	-0.46	-0.68	-0.98	-1.38	-1.66	-1.71	-2.12	-2.67	-2.78	-3.08	-3.45	-3.66
10000	10000.00	-0.00	0.01	-0.01	-0.08	-0.16	-0.49	-0.80	-1.13	-1.32	-1.44	-1.72	-2.25	-2.57	-2.74	-3.30	-3.49	-3.95	-4.12
10600	10592.50	-0.00	-0.02	-0.18	-0.44	-0.68	-0.93	-0.95	-1.09	-1.43	-1.89	-2.22	-2.35	-2.88	-3.31	-3.50	-4.13	-4.36	-4.64
11200	11220.20	0.00	-0.02	-0.08	-0.13	-0.05	-0.15	-0.48	-1.00	-1.21	-1.38	-1.78	-2.32	-2.55	-3.01	-3.50	-3.73	-4.36	-4.54
11800	11885.00	-0.00	0.02	0.01	-0.05	-0.28	-0.82	-1.17	-1.21	-1.45	-2.04	-2.28	-2.65	-3.25	-3.53	-4.03	-4.56	-5.04	-5.54
12500	12589.30	-0.00	-0.03	-0.23	-0.54	-0.87	-1.05	-0.98	-1.31	-1.90	-2.08	-2.56	-3.15	-3.36	-3.98	-4.44	-4.86	-5.42	-5.75
13200	13335.20	0.00	-0.02	-0.13	-0.24	-0.27	-0.44	-0.77	-1.35	-1.48	-1.92	-2.49	-2.74	-3.46	-3.76	-4.40	-4.85	-5.54	-5.99
14000	14125.40	-0.00	0.00	-0.08	-0.20	-0.42	-0.85	-1.20	-1.47	-1.81	-2.35	-2.64	-3.39	-3.63	-4.44	-4.84	-5.51	-6.06	-6.53
15000	14962.40	-0.00	-0.01	-0.11	-0.29	-0.54	-0.92	-1.15	-1.59	-2.04	-2.32	-3.03	-3.42	-4.20	-4.53	-5.20	-5.80	-6.52	-6.78
16000	15848.90	0.00	-0.03	-0.13	-0.37	-0.71	-1.08	-1.25	-1.79	-2.16	-2.70	-3.27	-3.73	-4.49	-5.07	-5.65	-6.31	-7.11	-7.72
17000	16788.00	0.00	0.00	-0.14	-0.36	-0.63	-0.97	-1.30	-1.94	-2.24	-2.92	-3.39	-4.12	-4.75	-5.44	-6.07	-6.66	-7.59	-8.07
18000	17782.80	0.00	-0.05	-0.25	-0.48	-0.71	-1.06	-1.54	-2.14	-2.40	-3.27	-3.67	-4.52	-5.26	-5.88	-6.58	-7.38	-8.19	-8.93
19000	18836.50	-0.00	-0.03	-0.25	-0.54	-0.75	-1.13	-1.71	-2.25	-2.67	-3.51	-4.10	-4.84	-5.69	-6.48	-7.12	-7.94	-8.95	-9.48
20000	19952.60	-0.00	-0.04	-0.25	-0.55	-0.85	-1.28	-1.80	-2.42	-2.97	-3.70	-4.54	-5.21	-6.21	-7.04	-7.80	-8.59	-9.59	-10.28

Nominal Frequency [Hz]	Actual Frequency [Hz]	Angle in Degrees																			
		90	95	100	105	110	115	120	125	130	135	140	145	150	155	160	165	170	175	180	
250	251.19	0.00	0.00	0.00	0.00	0.00	0.00	0.00	0.00	0.00	0.00	0.00	0.00	0.00	0.00	0.00	0.00	0.00	0.00	0.00	
315	316.23	0.01	0.01	-0.01	0.00	0.01	-0.01	0.00	0.00	0.00	0.00	0.01	0.00	0.00	0.00	-0.02	0.00	0.00	-0.01	-0.03	-0.03
400	398.11	0.00	-0.01	-0.03	-0.02	0.00	-0.04	-0.01	-0.02	0.00	-0.01	0.01	0.03	0.00	-0.01	0.02	0.02	0.01	0.00	-0.01	
500	501.19	-0.06	-0.05	-0.09	-0.08	-0.04	-0.09	-0.05	-0.07	-0.03	-0.05	-0.03	0.00	-0.03	-0.04	0.00	-0.01	-0.01	-0.01	-0.04	
630	630.96	-0.13	-0.06	-0.17	-0.10	-0.08	-0.17	-0.14	-0.12	-0.08	-0.09	-0.05	-0.08	-0.10	-0.11	-0.09	-0.12	-0.13	-0.09	-0.22	
800	794.33	-0.04	-0.04	-0.08	-0.08	-0.09	-0.09	-0.07	-0.09	-0.05	-0.05	-0.03	-0.04	-0.07	-0.06	-0.05	-0.03	-0.03	0.00	-0.06	
1000	1000.00	0.03	-0.02	-0.06	-0.09	-0.06	-0.09	-0.06	-0.10	-0.09	-0.10	-0.07	-0.04	-0.04	-0.06	-0.01	0.00	0.02	0.04	0.00	
1060	1059.25	0.03	0.00	-0.06	-0.09	-0.07	-0.10	-0.08	-0.12	-0.10	-0.12	-0.09	-0.06	-0.07	-0.10	-0.05	-0.06	-0.04	-0.02	-0.08	
1120	1122.02	0.01	0.01	-0.06	-0.09	-0.10	-0.12	-0.10	-0.14	-0.12	-0.14	-0.11	-0.08	-0.09	-0.11	-0.06	-0.06	-0.04	-0.03	-0.06	
1180	1188.50	-0.05	-0.02	-0.07	-0.11	-0.13	-0.15	-0.13	-0.17	-0.15	-0.17	-0.15	-0.11	-0.12	-0.13	-0.07	-0.06	-0.03	-0.02	-0.01	
1250	1258.93	-0.14	-0.11	-0.14	-0.15	-0.19	-0.23	-0.20	-0.23	-0.21	-0.24	-0.23	-0.20	-0.21	-0.22	-0.19	-0.18	-0.13	-0.13	-0.11	
1320	1333.52	-0.20	-0.21	-0.23	-0.20	-0.23	-0.31	-0.28	-0.31	-0.28	-0.32	-0.30	-0.28	-0.29	-0.29	-0.29	-0.27	-0.22	-0.22	-0.22	
1400	1412.54	-0.21	-0.24	-0.27	-0.23	-0.23	-0.31	-0.29	-0.33	-0.30	-0.36	-0.32	-0.29	-0.28	-0.27	-0.26	-0.21	-0.15	-0.13	-0.16	
1500	1496.24	-0.22	-0.22	-0.25	-0.23	-0.22	-0.27	-0.28	-0.33	-0.30	-0.35	-0.32	-0.27	-0.28	-0.29	-0.28	-0.23	-0.18	-0.15	-0.19	
1600	1584.89	-0.26	-0.23	-0.23	-0.23	-0.23	-0.24	-0.27	-0.32	-0.29	-0.34	-0.31	-0.24	-0.26	-0.27	-0.25	-0.21	-0.18	-0.16	-0.19	
1700	1678.80	-0.27	-0.22	-0.18	-0.20	-0.19	-0.19	-0.21	-0.27	-0.25	-0.31	-0.28	-0.22	-0.21	-0.22	-0.18	-0.11	-0.06	-0.03	-0.06	
1800	1778.28	-0.23	-0.22	-0.16	-0.15	-0.16	-0.15	-0.15	-0.23	-0.21	-0.26	-0.26	-0.21	-0.17	-0.21	-0.21	-0.18	-0.11	-0.07	-0.09	
1900	1883.65	-0.19	-0.22	-0.20	-0.12	-0.12	-0.15	-0.10	-0.19	-0.18	-0.21	-0.24	-0.19	-0.11	-0.12	-0.09	-0.04	0.05	0.07	0.10	
2000	1995.26	-0.25	-0.23	-0.29	-0.17	-0.12	-0.23	-0.13	-0.18	-0.24	-0.21	-0.29	-0.24	-0.18	-0.19	-0.20	-0.18	-0.09	-0.04	0.01	
2120	2113.49	-0.42	-0.38	-0.40	-0.37	-0.23	-0.33	-0.26	-0.25	-0.39	-0.35	-0.38	-0.36	-0.29	-0.26	-0.25	-0.18	-0.11	-0.04	-0.06	
2240	2238.72	-0.48	-0.63	-0.54	-0.60	-0.48	-0.45	-0.47	-0.43	-0.53	-0.55	-0.55	-0.59	-0.48	-0.50	-0.52	-0.49	-0.42	-0.29	-0.33	
2360	2371.37	-0.51	-0.65	-0.73	-0.67	-0.68	-0.53	-0.55	-0.56	-0.56	-0.67	-0.64	-0.67	-0.60	-0.55	-0.52	-0.50	-0.39	-0.29	-0.31	
2500	2511.89	-0.55	-0.68	-0.77	-0.73	-0.74	-0.64	-0.57	-0.63	-0.59	-0.72	-0.69	-0.72	-0.65	-0.59	-0.58	-0.59	-0.50	-0.41	-0.42	
2650	2660.73	-0.43	-0.55	-0.65	-0.76	-0.67	-0.65	-0.53	-0.59	-0.55	-0.72	-0.66	-0.71	-0.65	-0.60	-0.56	-0.56	-0.45	-0.29	-0.27	
2800	2818.38	-0.46	-0.55	-0.65	-0.75	-0.71	-0.72	-0.55	-0.61	-0.59	-0.72	-0.72	-0.76	-0.74	-0.60	-0.53	-0.54	-0.43	-0.31	-0.32	
3000	2985.38	-0.71	-0.70	-0.83	-0.90	-0.97	-0.88	-0.75	-0.72	-0.76	-0.81	-0.96	-0.92	-1.00	-0.83	-0.76	-0.82	-0.75	-0.60	-0.60	
3150	3162.28	-0.84	-0.85	-0.88	-1.10	-1.15	-1.10	-1.01	-0.79	-0.88	-0.85	-1.12	-1.02	-1.20	-1.06	-0.95	-1.02	-0.93	-0.75	-0.69	
3350	3349.65	-1.00	-0.80	-0.90	-1.05	-1.16	-1.29	-1.03	-0.91	-0.87	-0.87	-1.07	-1.04	-1.20	-1.11	-0.95	-0.99	-0.91	-0.71	-0.65	
3550	3548.13	-0.97	-0.92	-0.78	-0.80	-1.12	-1.20	-1.09	-0.99	-0.78	-0.84	-0.91	-0.99	-1.10	-1.07	-0.81	-0.84	-0.81	-0.62	-0.57	
3750	3758.37	-1.25	-1.10	-0.88	-0.94	-0.98	-1.24	-1.31	-1.10	-0.86	-0.93	-0.92	-1.11	-1.13	-1.16	-0.87	-0.85	-0.86	-0.68	-0.66	
4000	3981.07	-1.33	-1.47	-1.39	-1.06	-1.10	-1.49	-1.52	-1.35	-1.19	-1.14	-1.11	-1.38	-1.33	-1.43	-1.12	-1.03	-1.09	-0.93	-0.90	
4250	4216.97	-1.42	-1.71	-1.57	-1.34	-1.34	-1.48	-1.61	-1.69	-1.47	-1.25	-1.29	-1.49	-1.45	-1.60	-1.29	-1.18	-1.23	-1.07	-1.02	
4500	4466.84	-1.09	-1.47	-1.81	-1.62	-1.20	-1.25	-1.63	-1.82	-1.47	-1.20	-1.31	-1.39	-1.45	-1.60	-1.35	-1.14	-1.19	-1.00	-0.94	
4750	4731.51	-1.19	-1.42	-1.77	-1.77	-1.45	-1.43	-1.66	-1.76	-1.56	-1.43	-1.41	-1.30	-1.62	-1.66	-1.50	-1.19	-1.23	-1.03	-0.92	

Nominal Frequency [Hz]	Actual Frequency [Hz]	Angle in Degrees																		
		90	95	100	105	110	115	120	125	130	135	140	145	150	155	160	165	170	175	180
5000	5011.87	-1.54	-1.54	-1.97	-2.36	-2.08	-1.67	-1.68	-2.07	-2.18	-1.95	-1.68	-1.64	-2.04	-2.00	-1.93	-1.63	-1.64	-1.37	-1.24
5300	5308.84	-1.97	-1.84	-1.95	-2.45	-2.54	-2.13	-1.97	-2.36	-2.54	-2.17	-1.83	-1.93	-2.27	-2.18	-2.22	-1.86	-1.93	-1.71	-1.57
5600	5623.41	-1.90	-1.97	-1.84	-2.19	-2.63	-2.35	-1.91	-2.14	-2.42	-2.20	-1.96	-2.06	-2.26	-2.20	-2.25	-1.83	-1.86	-1.63	-1.50
6000	5956.62	-1.98	-2.40	-2.27	-2.24	-2.80	-2.94	-2.34	-2.24	-2.58	-2.60	-2.33	-2.27	-2.25	-2.50	-2.48	-2.11	-2.03	-1.76	-1.57
6300	6309.57	-1.97	-2.41	-2.66	-2.33	-2.52	-3.10	-2.82	-2.54	-2.81	-2.94	-2.57	-2.33	-2.46	-2.86	-2.80	-2.41	-2.36	-2.16	-1.95
6700	6683.44	-2.28	-2.33	-2.93	-3.03	-2.93	-3.43	-3.27	-2.75	-2.94	-3.25	-2.84	-2.45	-2.69	-3.26	-3.09	-2.84	-2.68	-2.44	-2.21
7100	7079.46	-2.70	-2.53	-2.80	-3.16	-2.90	-3.24	-3.69	-3.21	-3.11	-3.53	-3.16	-2.69	-2.90	-3.27	-3.15	-2.90	-2.66	-2.49	-2.22
7500	7498.94	-3.25	-3.15	-3.03	-3.66	-3.59	-3.61	-4.21	-3.73	-3.25	-3.83	-3.91	-3.34	-3.41	-3.62	-3.67	-3.40	-3.14	-3.03	-2.78
8000	7943.28	-3.29	-3.52	-3.42	-3.57	-4.16	-3.83	-4.18	-4.54	-3.75	-3.90	-4.18	-3.68	-3.61	-3.79	-4.03	-3.74	-3.41	-3.38	-3.11
8500	8413.95	-3.34	-3.64	-3.82	-3.66	-4.19	-4.16	-4.40	-4.77	-4.11	-4.11	-4.63	-4.00	-3.65	-3.89	-4.28	-4.03	-3.57	-3.59	-3.25
9000	8912.51	-4.04	-4.17	-4.41	-4.47	-4.43	-5.18	-4.56	-5.53	-5.13	-4.45	-5.00	-4.78	-4.29	-4.50	-4.97	-4.73	-4.11	-4.21	-3.86
9500	9440.61	-4.08	-4.32	-4.57	-4.55	-4.70	-5.00	-5.17	-5.01	-5.59	-4.88	-5.00	-4.98	-4.43	-4.61	-5.29	-5.01	-4.21	-4.25	-3.94
10000	10000.00	-4.41	-4.95	-5.13	-5.26	-5.09	-5.64	-5.74	-5.67	-6.17	-5.59	-5.62	-5.57	-4.81	-5.16	-5.96	-5.78	-4.92	-4.99	-4.66
10600	10592.50	-4.84	-5.66	-5.73	-5.89	-5.99	-5.85	-6.61	-6.17	-6.86	-6.35	-6.05	-6.69	-5.69	-5.79	-6.38	-6.32	-5.56	-5.62	-5.33
11200	11220.20	-5.08	-5.29	-5.96	-5.82	-6.22	-5.98	-6.40	-6.63	-6.54	-6.77	-6.08	-6.38	-6.07	-5.74	-6.19	-6.46	-5.65	-5.71	-5.42
11800	11885.00	-5.81	-6.22	-6.60	-6.69	-6.84	-7.06	-7.08	-7.77	-7.39	-7.95	-6.88	-7.35	-6.86	-6.32	-6.89	-7.28	-6.63	-6.49	-6.22
12500	12589.30	-6.24	-6.68	-7.02	-7.57	-7.29	-7.66	-7.45	-8.08	-7.93	-8.49	-8.13	-7.96	-7.81	-6.96	-7.43	-8.07	-7.42	-7.11	-6.92
13200	13335.20	-6.47	-6.80	-7.26	-7.56	-7.63	-8.13	-8.10	-8.29	-8.45	-8.48	-8.34	-7.99	-8.30	-7.15	-7.48	-8.50	-7.89	-7.43	-7.36
14000	14125.40	-7.09	-7.62	-7.91	-8.27	-8.65	-8.89	-9.22	-8.90	-9.58	-9.60	-9.77	-8.84	-9.40	-7.94	-8.18	-9.45	-8.78	-8.17	-8.20
15000	14962.40	-7.77	-8.15	-8.31	-8.80	-9.13	-9.52	-9.70	-9.36	-9.89	-9.60	-9.91	-8.94	-9.53	-8.95	-8.85	-10.27	-9.43	-8.58	-8.69
16000	15848.90	-8.14	-8.57	-9.46	-9.82	-9.82	-10.40	-10.67	-10.30	-10.88	-11.05	-11.53	-10.63	-10.30	-9.99	-9.98	-11.23	-10.39	-9.57	-9.70
17000	16788.00	-9.03	-9.53	-9.85	-10.29	-10.41	-11.12	-11.48	-11.22	-11.33	-11.86	-11.73	-11.51	-11.22	-10.86	-10.22	-11.69	-11.46	-10.42	-10.51
18000	17782.80	-9.76	-10.24	-10.80	-10.99	-11.37	-11.93	-12.53	-12.49	-12.07	-12.86	-12.64	-12.84	-11.76	-11.89	-10.91	-12.08	-12.48	-11.15	-11.39
19000	18836.50	-10.50	-11.05	-11.74	-12.45	-12.44	-12.86	-13.22	-13.33	-12.90	-13.90	-13.76	-13.71	-13.09	-13.30	-12.01	-12.61	-13.63	-12.05	-12.01
20000	19952.60	-11.34	-11.75	-12.63	-13.00	-13.60	-13.92	-14.22	-14.21	-14.52	-14.27	-15.01	-14.99	-13.71	-14.36	-12.72	-13.38	-15.20	-13.07	-12.92

The maximum measurement uncertainty of the data is with 95 % probability (k=2).

- 250 Hz to 1 kHz 0.3 dB
- 1 kHz to 4 kHz 0.5 dB
- 4 kHz to 8 kHz 1.0 dB
- 8 kHz to 12.5 kHz 1.5 dB

Information for Calibration

Type Description

- Integrating sound level meter type NTi Audio XL2-TA

Standards

The XL2-TA Sound Level Meter has been certified in accordance with the class 1 requirements of

- ISO 61672-1 (2014 und 2003)
- ISO 61672-2 (2014 und 2003)
- ISO 61260 (2014 und 2003)
- DIN 45657 (2014)
- Welmec 7.2 «Software Guide» (2011)

Approval Identification

The XL2-TA Sound Level Meter requires the approved firmware as follows:

- Germany: V4.71
- France: V4.21
- Austria: V4.21
- Switzerland: V4.11

Hints for Performing the Electrical Measurements

Electrical input facility

(Refer IEC61672-1 paragraphs 5.1.15, 9.3.g)

The capsule replacement NTI-K65-15 is used to insert electrical signals to the preamplifier MA220. The device provides at one side a contact that corresponds to the center contact of the replaced microphone capsule, at the other side a BNC-plug for the electrical signals. The impedance at the output of the device is 15 pF with a maximum deviation of ± 1 pF. The electrical noise floor is measured by shorting the contacts of the BNC plug. Before the NTI-K65-15 can be mounted to the preamplifier MA220, the microphone capsule must first be detached. The nominal sensitivity S of the capsule is $S = 42$ mV/Pa. Measurements with the NTI-K65-15 therefore require that the sensitivity in the calibration menu is manually adjusted to $S = 42$ mV/Pa. The linear operating ranges according to IEC 61672 have been verified during the type approval procedure.

Certified Calibrator

The following sound level calibrators are certified with the XL2-TA with a 114 dB, 1 kHz reference signal.

- Larson Davis CAL200
- B&K 4231
- Norsonic Nor-1251, Nor-1256
- Microtech Gefell 4010

Compulsory Calibrated Applications

The following acoustic measurements have been verified by German PTB during the type approval process:

Instantaneous sound pressure levels:

- LAF
A-weighted sound pressure level with time weighting FAST
- LAS
A-weighted sound pressure level with time weighting SLOW
- LCF
C-weighted sound pressure level with time weighting FAST
- LCS
C-weighted sound pressure level with time weighting SLOW
- LZF
unweighted sound pressure level with time weighting FAST
- LZS
unweighted sound pressure level with time weighting SLOW
- LAI
A-weighted sound pressure level with time weighting IMPULSE

Time averaged sound pressure levels:

- LCpeak
Peak value of the C-weighted sound level
- LAeq
A-weighted average level
- LAE
A-weighted sound exposure level
- LAFT3eq
A-weighted clock-impulse maximum level with time weighting FAST for a clock-impulse duration of 3 seconds
- LAFT5eq
A-weighted clock-impulse maximum level with time weighting FAST for a clock-impulse duration of 5 seconds